

COMPLEMENTARY SILICON TRANSISTORS

The 2N3773/2N6099 are power-base power transistors designed for high power audio, disk head positions and other linear applications. These device can be used in power switching circuits such as relay or solenoid drivers, DC to DC converters or inverters.

FEATURES

- *High safe operating area(100 tested)
150W and 100V
- *Complement Characterized for linear operation
- *High DC Current Gain and low saturation voltage
Hfe=15(8A 4V)
Vce(sat)=1.4V(Ic=8A,Ib=0.8A)
- *For Low Distortion Complementary Designs

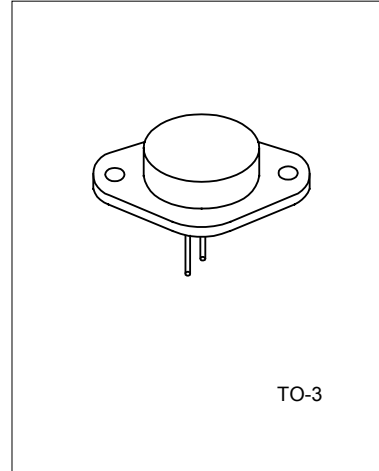

ABSOLUTE MAXIMUM RATINGS (Ta=25°C, unless otherwise specified)

PARAMETERS	SYMBOL	VALUE	UNITS
Collector-base voltage	V _{CB0}	160	V
Collector-emitter voltage	V _{CE0}	140	V
Emitter-base voltage	V _{EB0}	7	V
Collector-emitter voltage	V _{CEX}	160	V
Total Power dissipation T _c =25°C	P _c	150	W
Dertate above 25°C		0.855	W/°C
Collector current continuous	I _c	16	A
Peak		30	A
Base current continuous	I _B	4	A
Peak		15	A
Thermal resistance Junction to Case	R _{θJC}	1.17	°C/W
Storage Temperature	T _{STG}	-65 ~ +200	°C

ELECTRICAL CHARACTERISTICS (Ta=25°C, unless otherwise specified)

PARAMETER	SYMBOL	TEST CONDITIONS	MIN	TYP	MAX	UNIT
OFF CHARACTERISTICS						
Collector-Base Breakdown Voltage	BVCBO	Ic=0.2A, Ib=0	140			V
Collector-Emitter Sustaining Voltage	BVCEX	Ic=0.1A, Vbe(OFF)=1.5V Rbe=100Ω	160			V
Collector-Emitter Sustaining Voltage	BVCER	Ic=0.1A Rbe=100Ω	150			V
Collector Cut-off Current	ICBO	VCE=140V, IE=0			2	mA
Emitter Cut-off Current	IEBO	VBE=7V, Ic=0			5	mA
Collector Cut-off Current	ICEX	VCE=140V, VBE(off)=1.5V VCE=140V, VBE(off)=1.5V , Tc=150°C		2 10		mA mA
OFF CHARACTERISTICS						
DC current gain(note)	hFE1 hFE2	VCE=4V, Ic=8A VCE=4V, Ic=16A	15 5		60	
Collector-emitter saturation voltage	VCE(sat)	Ic=8A, Ib=800mA Ic=16A, Ib=3.2A			1.4 4	V
Base-emitter saturation voltage	VBE(on)	Ic=8A, VCE=4V			2.2	V
DYNAMIC CHARACTERISTICS						
Small Signal Current Gain	hFE	Ic=1A, VCE=4V, f=1kHz	40			
Magnitude of common-Emitter small signal, short circuit forward current transfer ratio	hFE	Ic=1A, f=50kHz	4			
Second breakdown collector with base forward biased	Is/b	t=1s(non-repetive), VCE=100V	1.5			A

TYPICAL PARAMETERS PERFORMANCES

2N3773

Figure 1 DC current gain

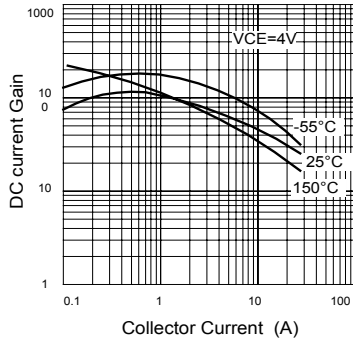

2N6609

Figure 2 DC current gain

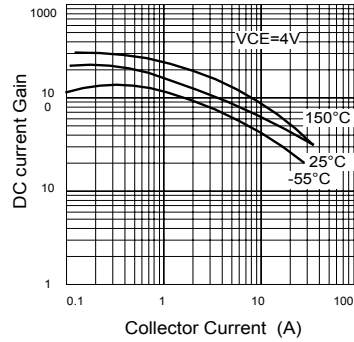

Figure 3 Collector saturation region

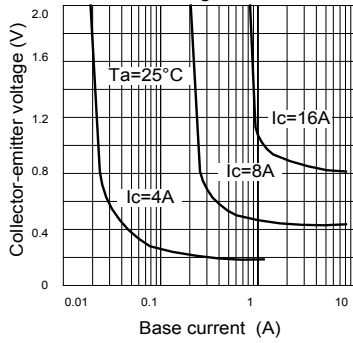

Figure 4 Collector saturation region

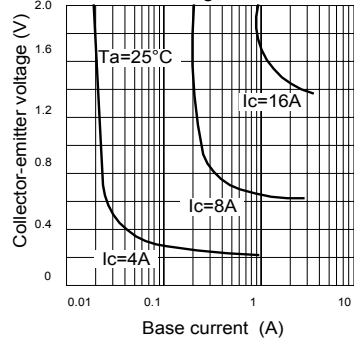

Figure 5 "ON" Voltage

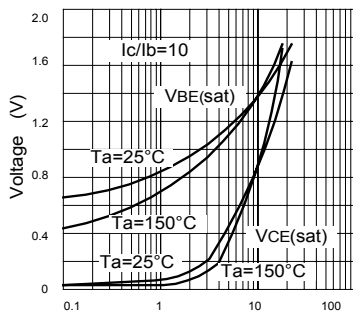

Figure 6 "ON" Voltage

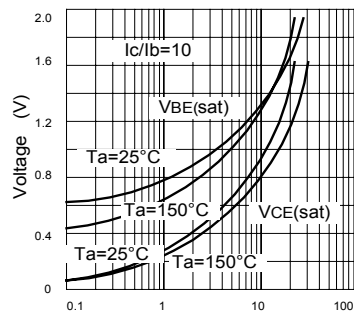

Figure 7 Turn-on Switching times

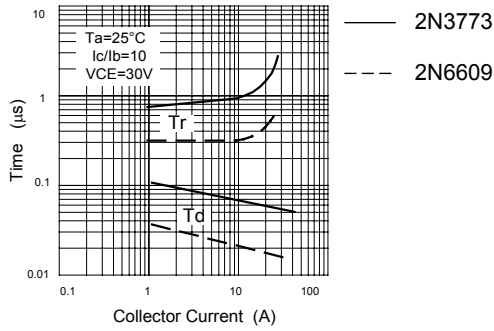

Figure 8 Turn-off Switching times

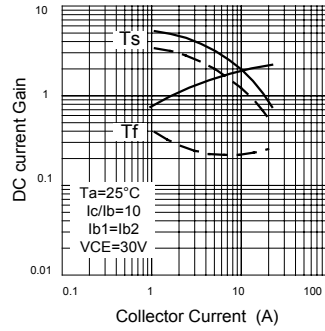

Figure 9 Current gain - bandwidth product

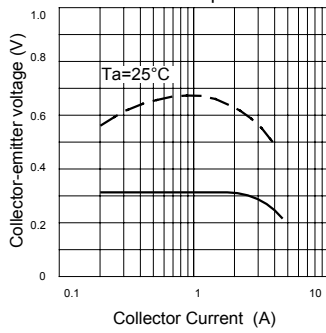

Figure 10 Capacitances

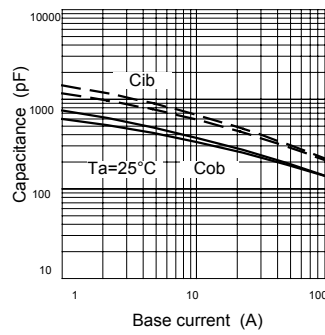
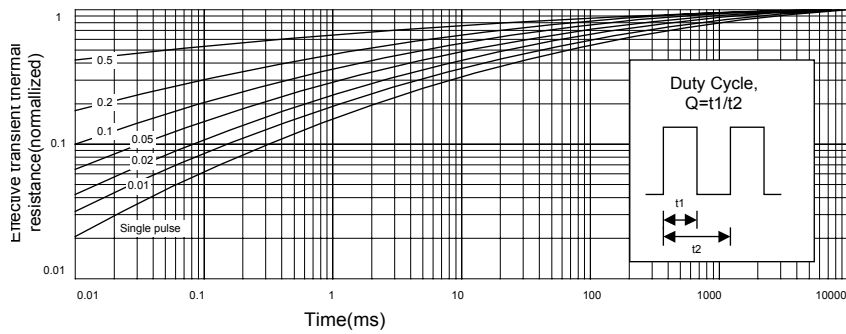

Figure 11 Thermal response



UTC assumes no responsibility for equipment failures that result from using products at values that exceed, even momentarily, rated values (such as maximum ratings, operating condition ranges, or other parameters) listed in products specifications of any and all UTC products described or contained herein. UTC products are not designed for use in life support appliances, devices or systems where malfunction of these products can be reasonably expected to result in personal injury. Reproduction in whole or in part is prohibited without the prior written consent of the copyright owner. The information presented in this document does not form part of any quotation or contract, is believed to be accurate and reliable and may be changed without notice.