

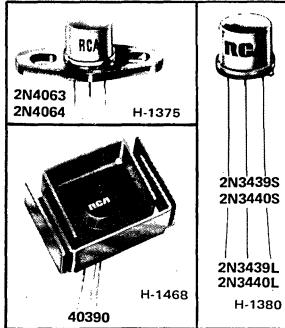

Power Transistors

2N4063
2N4064
2N3439
2N3440
2N4063
2N4064
40390



High-Voltage Silicon N-P-N Transistors

For High-Speed Switching and Linear-Amplifier Applications

Features

- High voltage ratings:
 - $V_{CB0} = 450 \text{ V max. (2N3439, 2N4063)}$
 - $= 300 \text{ V max. (2N3440, 2N4064)}$
 - $V_{CE0(sus)} = 350 \text{ V max. (2N3439, 2N4063)}$
 - $= 250 \text{ V max. (2N3440, 2N4064)}$
- Maximum-area-of-operation curves
- Low saturation voltages

These devices are available with either 1½-inch leads (TO-5 package) or ½-inch leads (TO-39 package). The longer-lead versions are specified by suffix "L" after the type number; the shorter-lead versions are specified by suffix "S" after the type number.

RCA-2N3439*, 2N3440**, 2N4063, 2N4064, and 40390 are epitaxial-base silicon n-p-n transistors with high breakdown voltages, high-frequency response, and fast switching speeds. These transistors are intended for industrial, commercial, and military equipment. Typical applications include high-voltage differential and operational amplifiers, high-voltage inverters, and high-voltage, low-current switching and series regulators.

The 2N3439 and the 2N3440 differ primarily in their voltage ratings; the 2N4063 and 2N4064 have the same voltage ratings as the 2N3439 and 2N3440 respectively, but employ a flange package. Type 40390 is a 2N3440 with a factory-attached heat radiator; it is intended for printed-circuit-board applications.

* Formerly RCA Dev. No. TA2458.
** Formerly RCA Dev. No. TA2470.

Absolute-Maximum Values:

	2N3439 2N4063	2N3440 2N4064 40390	
COLLECTOR-TO-BASE VOLTAGE	V_{CB0} 450	300	V
COLLECTOR-TO-EMITTER SUSTAINING VOLTAGE	$V_{CE0(sus)}$ 350	250	V
EMITTER-TO-BASE VOLTAGE	V_{EB0} 7	7	V
COLLECTOR CURRENT	I_C 1	1	A
BASE CURRENT	I_B 0.5	0.5	A
TRANSISTOR DISSIPATION	P_T		
At case temperatures up to 25° C	10	10(2N3440)	W
At free-air temperatures up to 25° C	—	10(2N4064)	W
At free-air temperatures up to 50° C	—	3.5(40390)	W
At free-air temperatures above 25° C or 50° C	1(2N3439)	1(2N3440)	W
For pulse operation	See Fig. 2.	See Fig. 9.	
TEMPERATURE RANGE:			
Storage & Operating (Junction)	← -65 to 200 →		°C
LEAD TEMPERATURE (During soldering):			
At distance ≥ 1/32 in. from seating plane for 10 s max.	← 255 →		°C

ELECTRICAL CHARACTERISTICS, At Case Temperature (T_C) = 25°C

Characteristic	Symbol	TEST CONDITIONS						LIMITS				Units	
		DC Collector Volts		DC Emitter or Base Volts		DC Current (milliamperes)		Types 2N3439 2N4063		Types 2N3440 2N4064 40390			
		V_{CB}	V_{CE}	V_{EB}	V_{BE}	I_C	I_E	I_B	Min.	Max.	Min.		Max.
Collector-Cutoff Current	I_{CEO}		300 200					0 0	- -	20 -	- -	- 50	μA μA
	I_{CEV}		450 300		-1.5 -1.5				- -	500 -	- -	- 500	μA μA
Emitter-Cutoff Current	I_{EBO}			6		0			-	20	-	20	μA
DC Forward-Current Transfer Ratio	h_{FE}		10 10			20 2			40 30	160 -	40 -	160 -	
Collector-to-Emitter Sustaining Voltage: (See Figs. 3 & 4.) With base open	$V_{CEO(sus)}$					50	0	350 ^a	-	250 ^a	-	-	V
Base-to-Emitter Saturation Voltage	$V_{BE(sat)}$					50	4	-	1.3	-	1.3	-	V
Collector-to-Emitter Saturation Voltage	$V_{CE(sat)}$					50	4	-	0.5	-	0.5	-	V
Small-Signal, Forward-Current Transfer Ratio (at 5 MHz)	h_{fe}		10			10			3	-	3	-	
Output Capacitance (at 1 MHz)	C_{ob}	10					0		-	10	-	10	pF
Second-Breakdown Collector Current: With base forward biased	$I_{S/b}$		200						50	-	50	-	mA
Thermal Resistance: Junction-to-Case	θ_{J-C}								-	17.5	-	17.5	°C/W

^aCAUTION: The sustaining voltage $V_{CEO(sus)}$ MUST NOT be measured on a curve tracer. The sustaining voltage should be measured by means of the test circuit shown in Fig. 3.

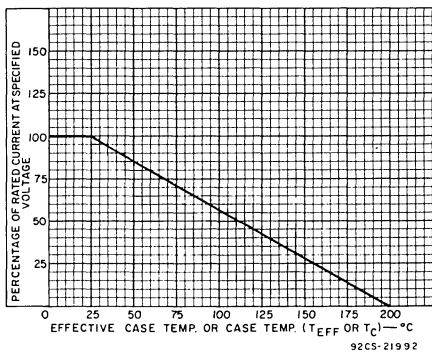

Fig. 1 - Current derating curve for all types.

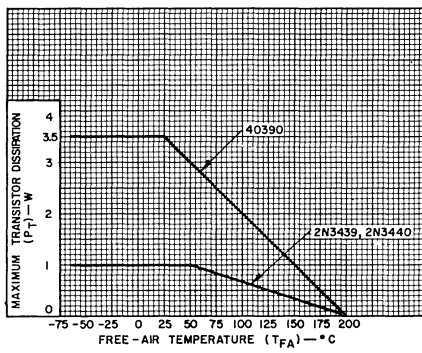

Fig. 2 - Dissipation derating curve for 2N3439, 2N3440, and 40390.

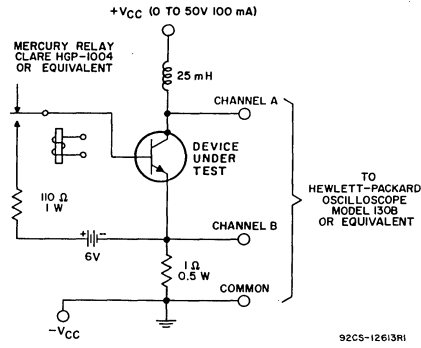
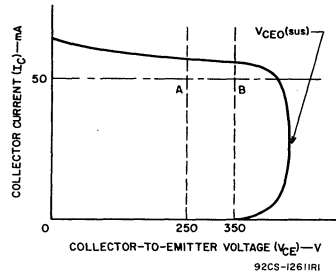

Fig. 3 - Circuit used to measure sustaining voltage, $V_{CE0(sus)}$, for all types.



The sustaining voltage $V_{CE0(sus)}$ is acceptable when the trace falls to the right and above point "A" for types 2N3440, 2N4064 and 40390. The trace must fall to the right and above point "B" for types 2N3439 and 2N4063.

Fig. 4 - Oscilloscope display for measurement of sustaining voltages (test circuit shown in Fig. 3).

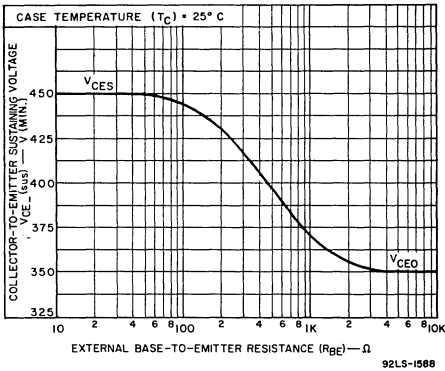

Fig. 5 - Sustaining voltage vs. base-to-emitter resistance for 2N3439 and 2N4063.

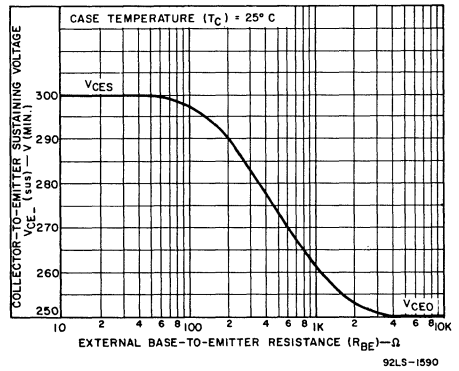

Fig. 6 - Sustaining voltage vs. base-to-emitter resistance for 2N3440, 2N4064, and 40390.

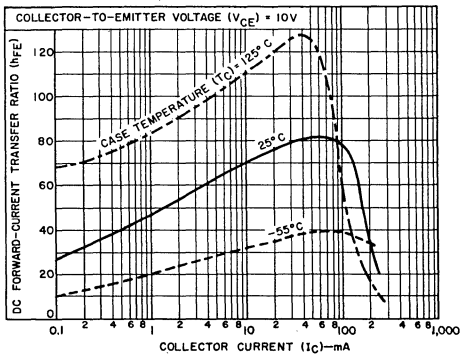

Fig. 7 - Typical dc-beta characteristics for all types.

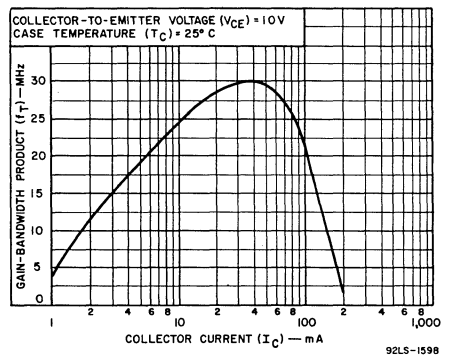

Fig. 8 - Typical gain-bandwidth product for all types.

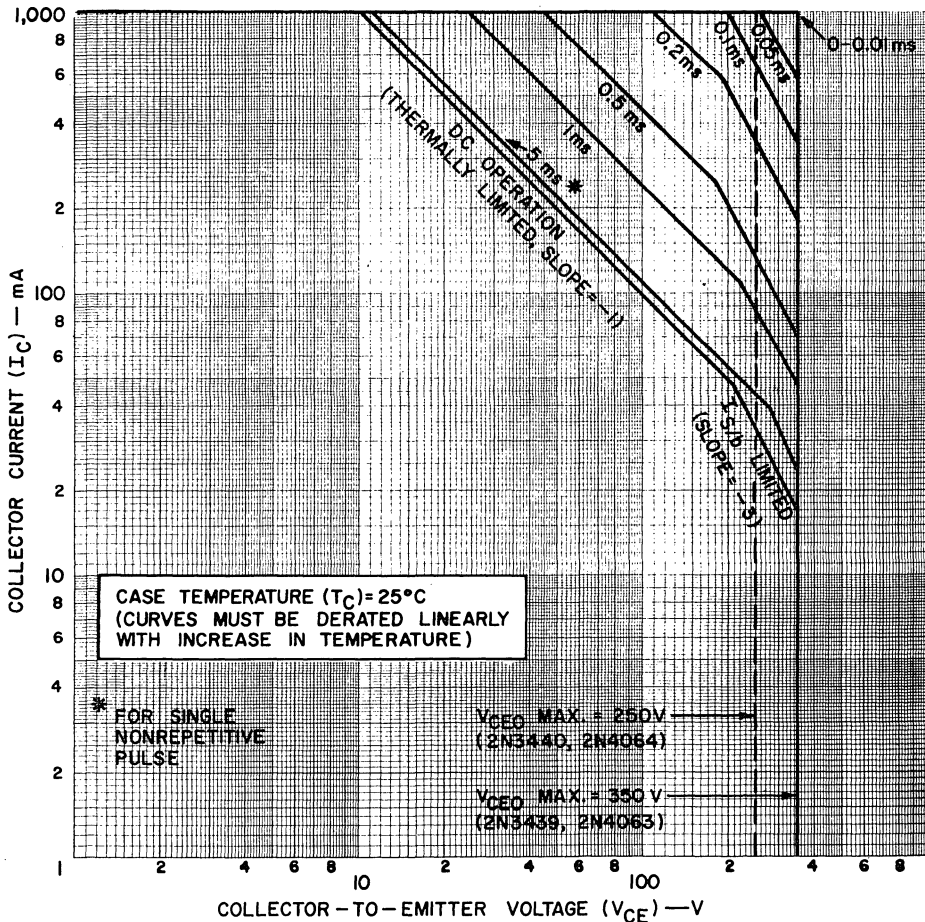

Fig. 9 — Maximum operating areas for 2N3439, 2N3440, 2N4063 and 2N4064.

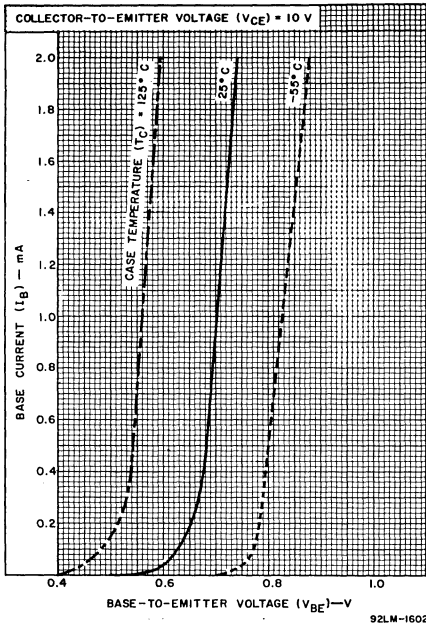

Fig. 10 — Typical input characteristics for all types.

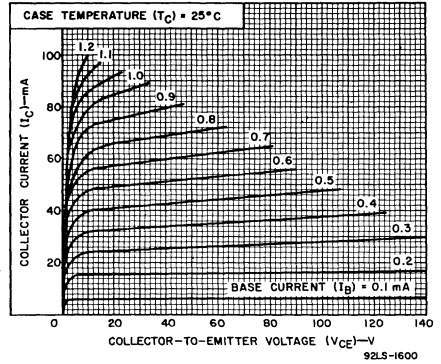

Fig. 11 — Typical output characteristics for all types.

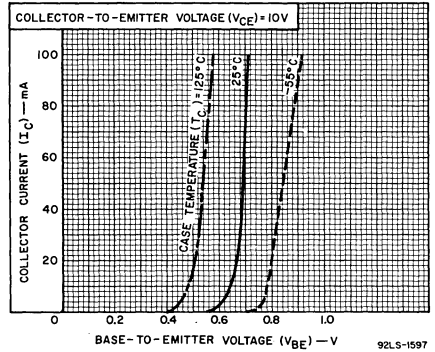

Fig. 12 — Typical transfer characteristics for all types.

TERMINAL CONNECTIONS
2N4063, 2N4064

- Lead 1 — Emitter
- Lead 2 — Base
- Flange, Lead 3 — Collector

TERMINAL CONNECTIONS
2N3439, 2N3440

- Lead 1 — Emitter
- Lead 2 — Base
- Case, Lead 3 — Collector

TERMINAL CONNECTIONS
40390

- Lead 1 — Emitter
- Lead 2 — Base
- Heat-Radiator, Lead 3 — Collector