

2N5086 / 2N5087

PNP Silicon Epitaxial Planar Transistor

for switching and AF amplifier applications.

The transistor is subdivided into one group according to its DC current gain. As complementary type the NPN transistor 2N5088 and 2N5089 are recommended.



1. Emitter 2. Base 3. Collector
TO-92 Plastic Package

Absolute Maximum Ratings ($T_a = 25\text{ }^\circ\text{C}$)

Parameter	Symbol	Value	Unit
Collector Base Voltage	$-V_{CBO}$	50	V
Collector Emitter Voltage	$-V_{CEO}$	50	V
Emitter Base Voltage	$-V_{EBO}$	3	V
Collector Current	$-I_C$	50	mA
Power Dissipation	P_{tot}	500	mW
Junction Temperature	T_j	150	$^\circ\text{C}$
Storage Temperature Range	T_{stg}	- 55 to + 150	$^\circ\text{C}$

Characteristics at $T_a = 25\text{ }^\circ\text{C}$

Parameter	Symbol	Min.	Max.	Unit	
DC Current Gain at $-V_{CE} = 5\text{ V}$, $-I_C = 0.1\text{ mA}$ at $-V_{CE} = 5\text{ V}$, $-I_C = 1\text{ mA}$ at $-V_{CE} = 5\text{ V}$, $-I_C = 10\text{ mA}$	2N5086	h_{FE}	150	500	-
	2N5087	h_{FE}	200	800	-
	2N5086	h_{FE}	150	-	-
	2N5087	h_{FE}	200	-	-
	2N5086	h_{FE}	150	-	-
	2N5087	h_{FE}	200	-	-
Collector Base Cutoff Current at $-V_{CB} = 35\text{ V}$	$-I_{CBO}$	-	50	nA	
Emitter Base Cutoff Current at $-V_{EB} = 3\text{ V}$	$-I_{EBO}$	-	50	nA	
Collector Base Breakdown Voltage at $-I_C = 100\text{ }\mu\text{A}$	$-V_{(BR)CBO}$	50	-	V	
Collector Emitter Breakdown Voltage at $-I_C = 1\text{ mA}$	$-V_{(BR)CEO}$	50	-	V	
Emitter Base Breakdown Voltage at $-I_E = 10\text{ }\mu\text{A}$	$-V_{(BR)EBO}$	3	-	V	
Collector Emitter Saturation Voltage at $-I_C = 10\text{ mA}$, $-I_B = 1\text{ mA}$	$-V_{CE(sat)}$	-	0.3	V	
Base Emitter Voltage at $-V_{CE} = 5\text{ V}$, $-I_C = 1\text{ mA}$	$-V_{BE(on)}$	-	0.85	V	
Gain Bandwidth Product at $-V_{CE} = 5\text{ V}$, $-I_C = 0.5\text{ mA}$	f_T	40	-	MHz	
Collector Output Capacitance at $-V_{CB} = 10\text{ V}$, $f = 1\text{ MHz}$	C_{ob}	-	4	pF	

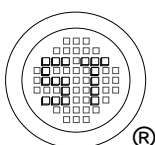

SEMTECH ELECTRONICS LTD.



Dated : 16/08/2016 Rev: 01

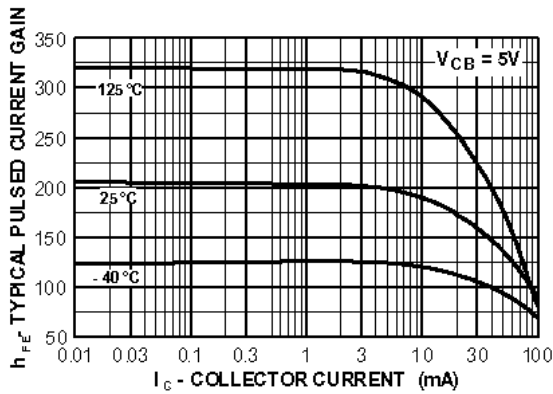

Figure 1. Typical Pulsed Current Gain vs Collector Current

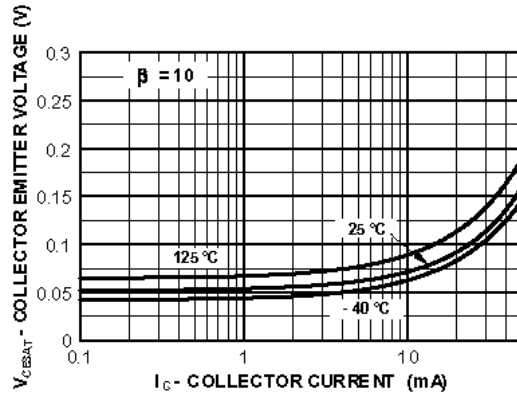

Figure 2. Collector-Emitter Saturation Voltage vs Collector Current

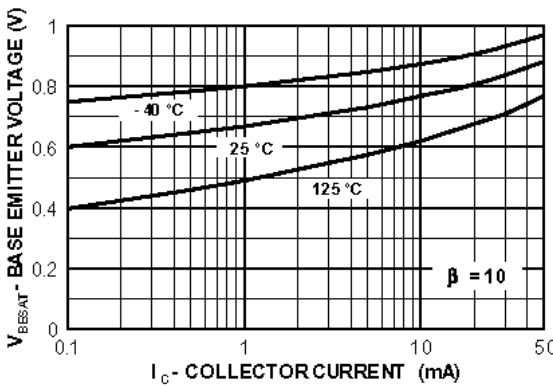

Figure 3. Base-Emitter Saturation Voltage vs Collector Current

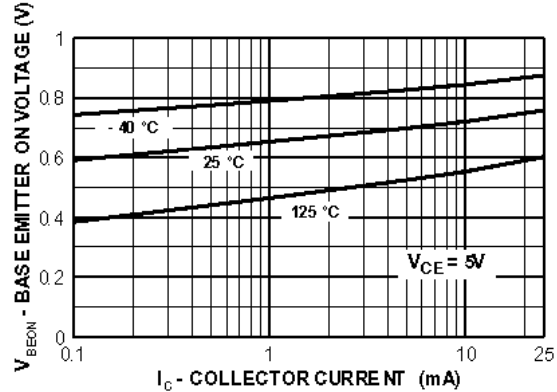

Figure 4. Base-Emitter On Voltage vs Collector Current

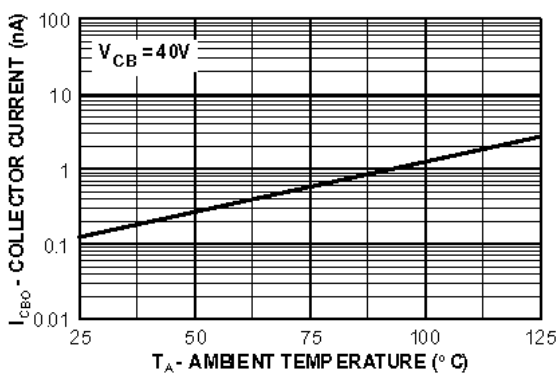

Figure 5. Collector Cutoff Current vs Ambient Temperature

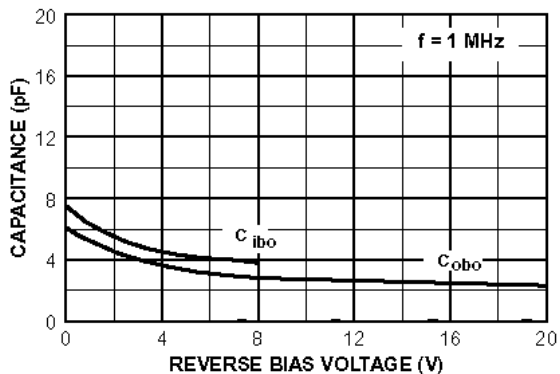
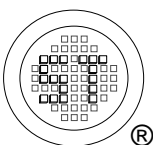

Figure 6. Input and Output Capacitance vs Reverse Volt



SEMTECH ELECTRONICS LTD.



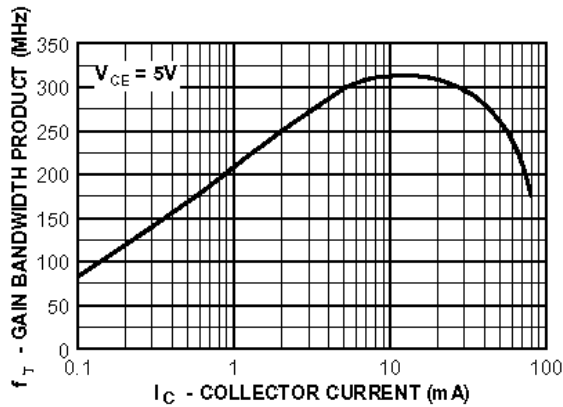

Figure 7. Gain Bandwidth Product vs Collector Current

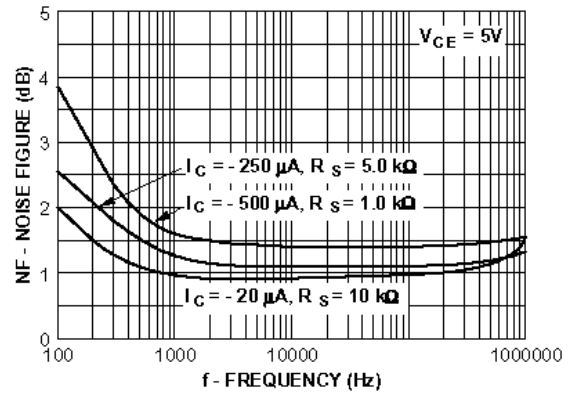

Figure 8. Noise Figure vs Frequency

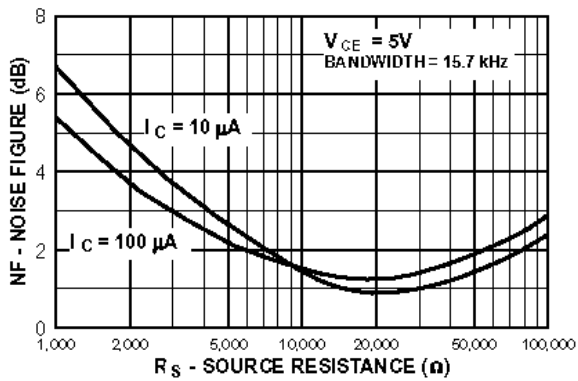

Figure 9. Wideband Noise Frequency vs Source Resistance

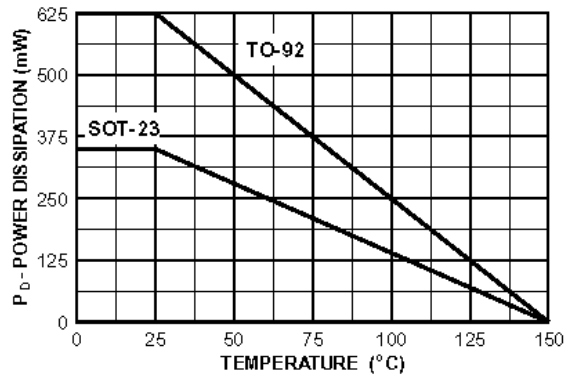

Figure 10. Power Dissipation vs Ambient Temperature

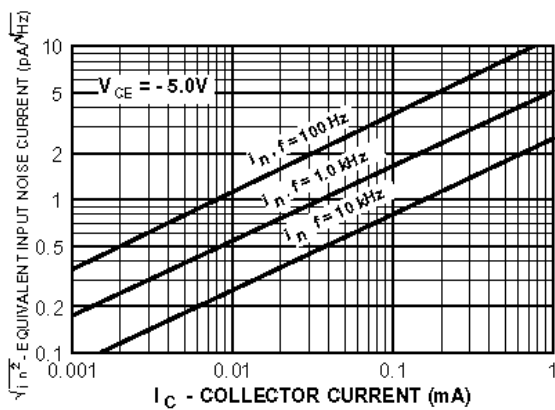

Figure 11. Equivalent Input Noise Current vs Collector Current

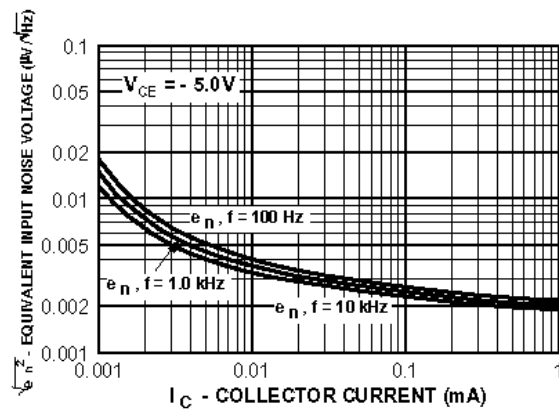
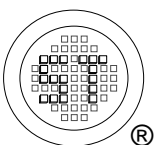

Figure 12. Equivalent Input Noise Voltage vs Collector Current



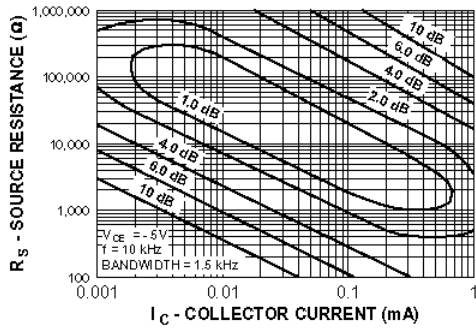

Figure 13. Contours of Constant Narrow Band Noise Figure

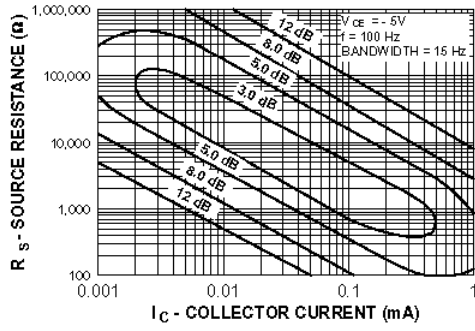

Figure 14. Contours of Constant Narrow Band Noise Figure

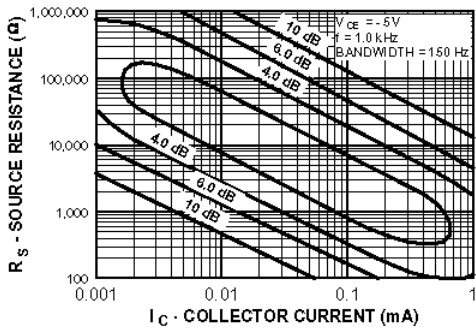

Figure 15. BContours of Constant Narrow Band Noise Figure

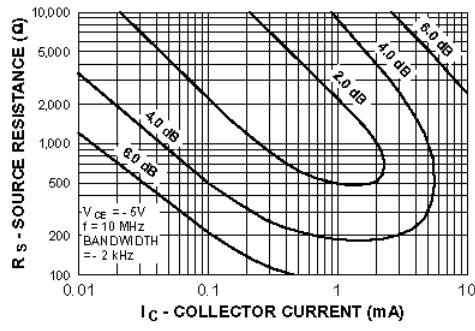
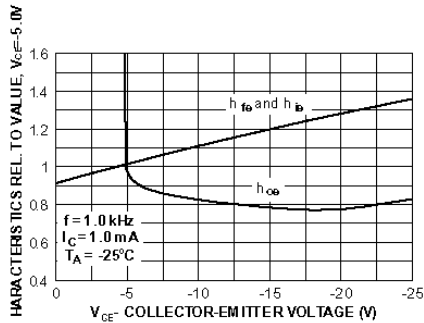
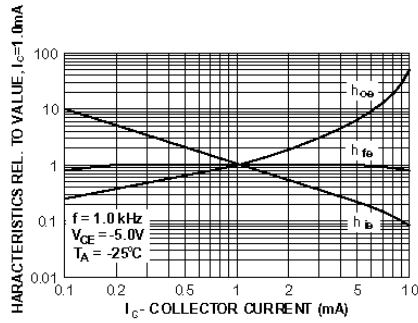

Figure 16. Contours of Constant Narrow Band Noise Figure



Typical Common Emitter Characteristics



Typical Common Emitter Characteristics

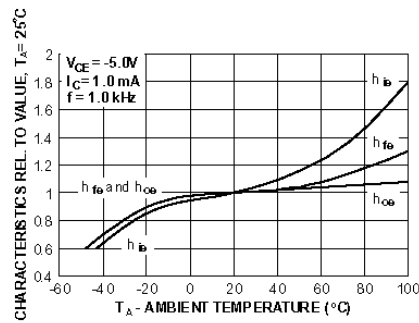

Typical Common Emitter Characteristics

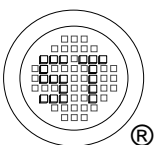

SEMTECH ELECTRONICS LTD.

