

2N5109

JAN, JTX, JTXV AVAILABLE
CASE 79-02, STYLE 1
TO-39 (TO-205AD)

HIGH FREQUENCY TRANSISTOR

NPN SILICON



MAXIMUM RATINGS

Rating	Symbol	Value	Unit
Collector-Emitter Voltage	V_{CEO}	20	Vdc
Collector-Base Voltage	V_{CBO}	40	Vdc
Emitter-Base Voltage	V_{EBO}	3.0	Vdc
Base Current	I_B	400	mAdc
Collector Current — Continuous	I_C	400	mAdc
Total Device Dissipation @ $T_C = 75^\circ\text{C}$ (1) Derate above 25°C	P_D	2.5 20	Watt mW/°C
Storage Temperature	T_{stg}	-65 to +200	°C

(1) Total Device Dissipation at $T_A = 25^\circ\text{C}$ is 1.0 Watt.

ELECTRICAL CHARACTERISTICS ($T_A = 25^\circ\text{C}$ unless otherwise noted.)

Characteristic	Symbol	Min	Typ	Max	Unit
OFF CHARACTERISTICS					
Collector-Emitter Breakdown Voltage(2) ($I_C = 5.0$ mAdc, $R_{BE} = 10 \Omega$)	$V_{(BR)CER}$	40	—	—	Vdc
Collector-Emitter Sustaining Voltage ($I_C = 5.0$ mAdc, $I_B = 0$)	$V_{(BR)CEO}$	20	—	—	Vdc
Collector Cutoff Current ($V_{CE} = 15$ Vdc, $I_B = 0$)	I_{CEO}	—	—	20	μAdc
Collector Cutoff Current ($V_{CE} = 15$ Vdc, $V_{BE} = -1.5$ V, $T_C = 150^\circ\text{C}$) ($V_{CE} = 35$ Vdc, $V_{BE} = -1.5$ V)	I_{CEX}	—	—	5.0 5.0	mAdc mAdc
Emitter Cutoff Current ($V_{BE} = 3.0$ Vdc, $I_C = 0$)	I_{EBO}	—	—	100	μAdc
ON CHARACTERISTICS					
DC Current Gain ($I_C = 360$ mAdc, $V_{CE} = 5.0$ Vdc) ($I_C = 50$ mAdc, $V_{CE} = 15$ Vdc)	h_{FE}	5.0 40	— —	— 120	— —
SMALL SIGNAL CHARACTERISTICS					
Current-Gain — Bandwidth Product ($I_C = 50$ mAdc, $V_{CE} = 15$ Vdc, $f = 200$ MHz)	f_T	1200	—	—	MHz
Collector-Base Capacitance ($V_{CB} = 15$ Vdc, $I_E = 0$, $f = 1.0$ MHz)	C_{cb}	—	1.8	3.5	pF
Noise Figure ($I_C = 10$ mAdc, $V_{CE} = 15$ Vdc, $f = 200$ MHz)	NF	—	3.0	—	dB
FUNCTIONAL TEST					
Common-Emitter Amplifier Voltage Gain (Figure 1) ($I_C = 50$ mAdc, $V_{CC} = 15$ Vdc, $f = 50$ to 216 MHz)	G_{ve}	11	—	—	dB
Power Input (Figure 2) ($I_C = 50$ mAdc, $V_{CC} = 15$ Vdc, $R_S = 50$ ohms, $P_{out} = 1.26$ mW, $f = 200$ MHz)	P_{in}	—	—	0.1	mW

(2) Pulsed thru a 25 mH Inductor; 50% Duty Cycle.

FIGURE 1 - RF AMPLIFIER FOR VOLTAGE GAIN TEST CIRCUIT

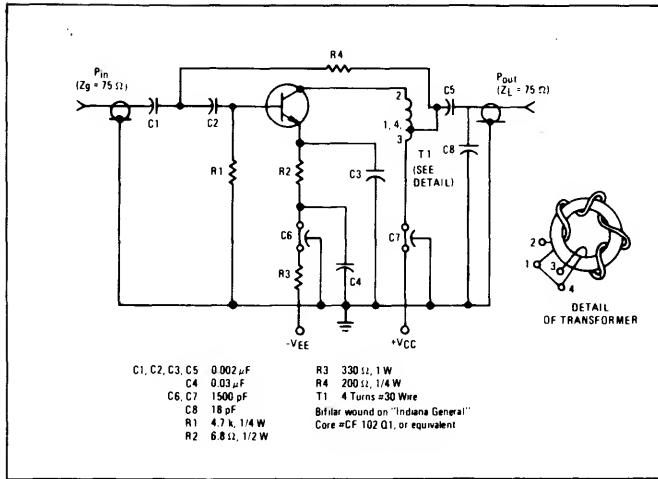
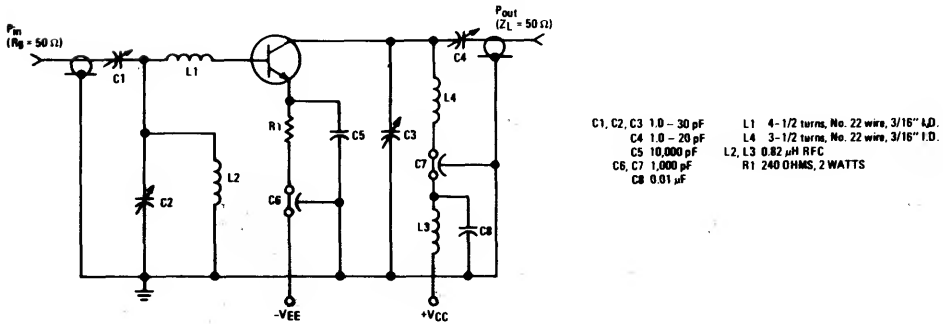

FIGURE 2 - 200 MHz TEST CIRCUIT



7

FIGURE 3 - CURRENT GAIN - BANDWIDTH PRODUCT

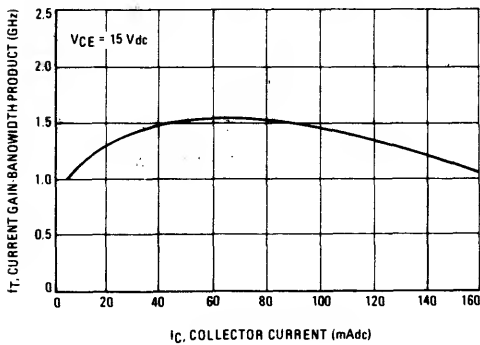

FIGURE 4 - COLLECTOR-BASE TIME CONSTANT

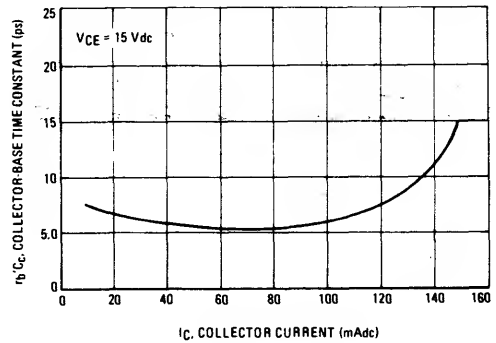

FIGURE 5 – SATURATION VOLTAGES

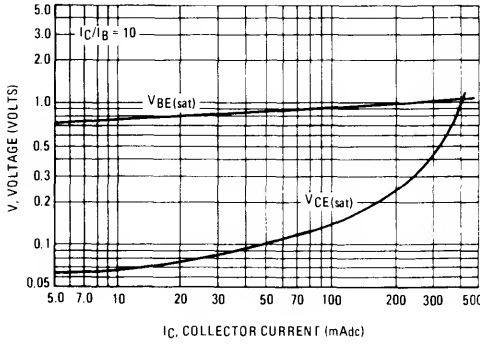

FIGURE 6 – CAPACITANCES versus REVERSE VOLTAGE

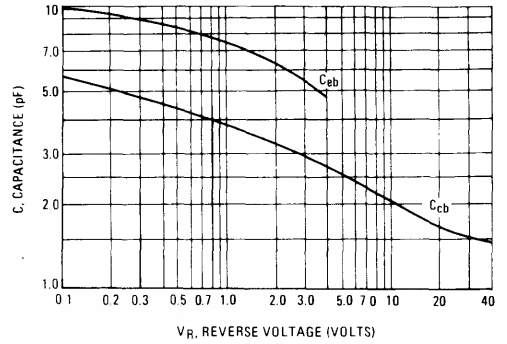

FIGURE 7 – INPUT ADMITTANCE versus FREQUENCY

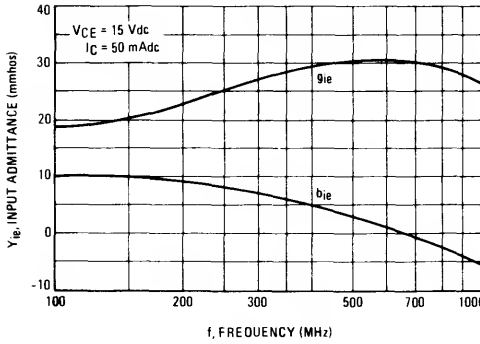

FIGURE 8 – INPUT ADMITTANCE versus COLLECTOR CURRENT

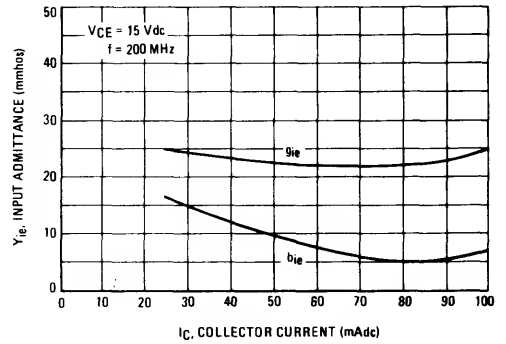

FIGURE 9 – REVERSE TRANSFER ADMITTANCE versus FREQUENCY

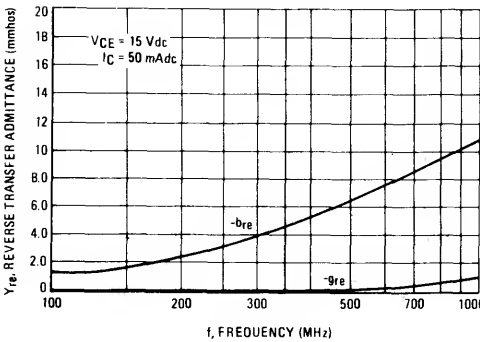
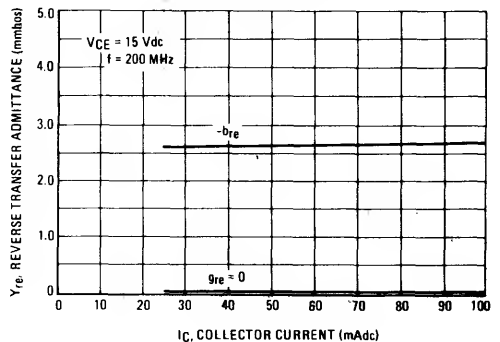

FIGURE 10 – REVERSE TRANSFER ADMITTANCE versus COLLECTOR CURRENT



7

FIGURE 11 – FORWARD TRANSFER ADMITTANCE versus FREQUENCY

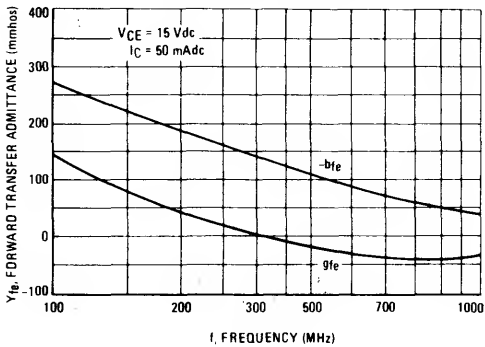

FIGURE 12 – FORWARD TRANSFER ADMITTANCE versus COLLECTOR CURRENT

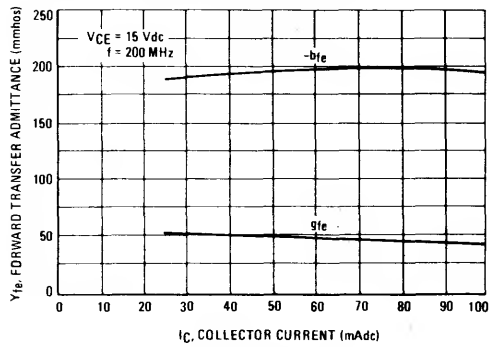

FIGURE 13 – OUTPUT ADMITTANCE versus FREQUENCY

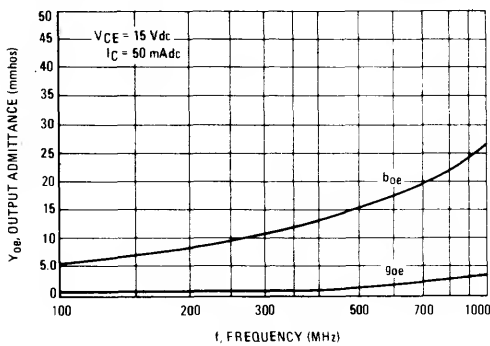

FIGURE 14 – OUTPUT ADMITTANCE versus COLLECTOR CURRENT

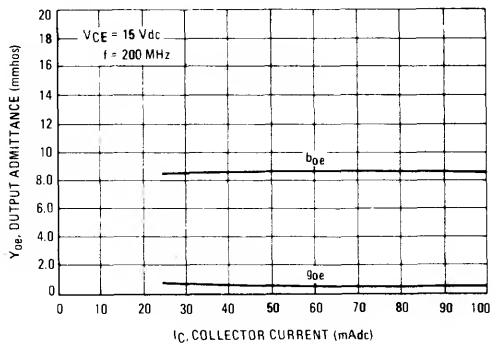

FIGURE 15 – INPUT REFLECTION COEFFICIENT versus FREQUENCY

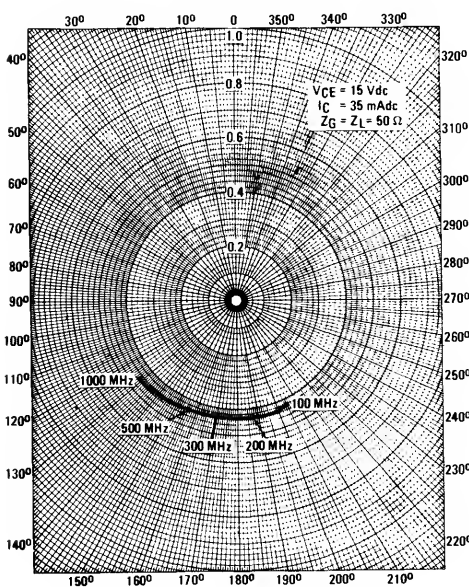
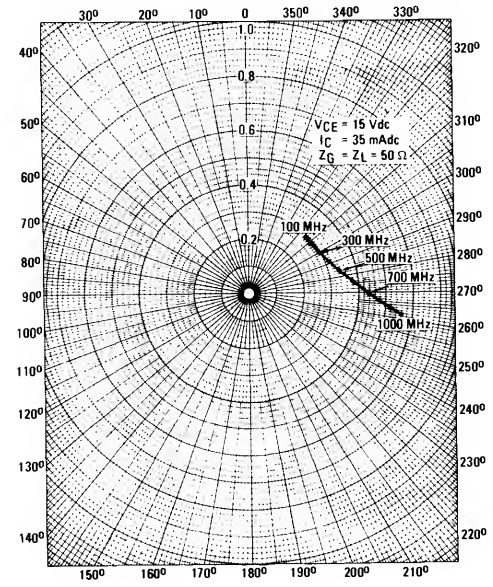

FIGURE 16 – OUTPUT REFLECTION COEFFICIENT versus FREQUENCY



7

FIGURE 17 - REVERSE TRANSMISSION COEFFICIENT versus FREQUENCY

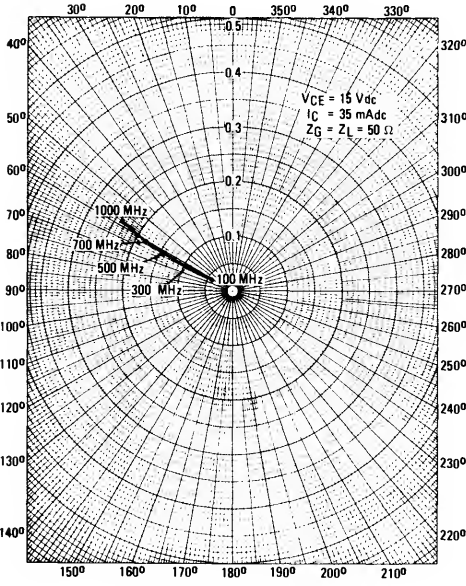

FIGURE 18 - FORWARD TRANSMISSION COEFFICIENT versus FREQUENCY

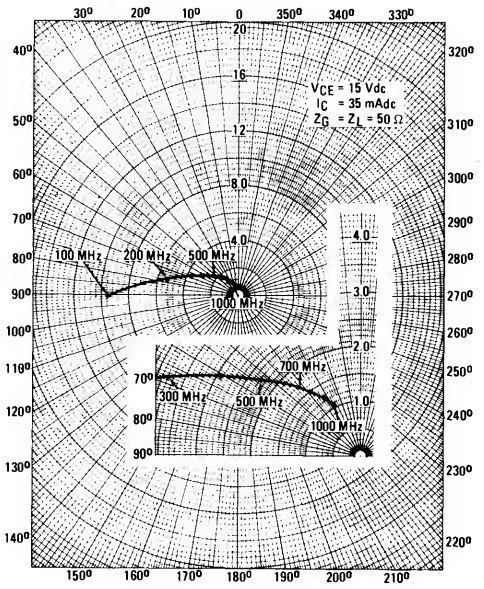

FIGURE 19 - INPUT REFLECTION COEFFICIENT AND OUTPUT REFLECTION COEFFICIENT versus FREQUENCY

