

Silicon PNP Power Transistors

... for use in power amplifier and switching circuits, — excellent safe area limits.
 Complement to NPN 2N5191, 2N5192

2N5194 2N5195*

*Motorola Preferred Device

**4 AMPERE
POWER TRANSISTORS
SILICON PNP
60–80 VOLTS**

*MAXIMUM RATINGS

Rating	Symbol	2N5194	2N5195	Unit
Collector–Emitter Voltage	V_{CEO}	60	80	Vdc
Collector–Base Voltage	V_{CB}	60	80	Vdc
Emitter–Base Voltage	V_{EB}	5.0		Vdc
Collector Current	I_C	4.0		Adc
Base Current	I_B	1.0		Adc
Total Power Dissipation @ $T_C = 25^\circ\text{C}$ Derate above 25°C	P_D	40	320	Watts mW/ $^\circ\text{C}$
Operating and Storage Junction Temperature Range	T_J, T_{stg}	–65 to +150		$^\circ\text{C/W}$

THERMAL CHARACTERISTICS

Characteristic	Symbol	Max	Unit
Thermal Resistance, Junction to Case	θ_{JC}	3.12	$^\circ\text{C/W}$

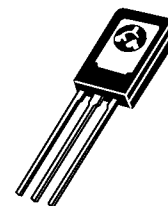

CASE 77–08
TO–225AA TYPE

*ELECTRICAL CHARACTERISTICS ($T_C = 25^\circ\text{C}$ unless otherwise noted)

Characteristic	Symbol	Min	Max	Unit
----------------	--------	-----	-----	------

OFF CHARACTERISTICS

Collector–Emitter Sustaining Voltage (1) ($I_C = 0.1 \text{ Adc}, I_B = 0$)	2N5194 2N5195	$V_{CEO(sus)}$	60 80	— —	Vdc
Collector Cutoff Current ($V_{CE} = 60 \text{ Vdc}, I_B = 0$) ($V_{CE} = 80 \text{ Vdc}, I_B = 0$)	2N5194 2N5195	I_{CEO}	— —	1.0 1.0	mAdc
Collector Cutoff Current ($V_{CE} = 60 \text{ Vdc}, V_{BE(off)} = 1.5 \text{ Vdc}$) ($V_{CE} = 80 \text{ Vdc}, V_{BE(off)} = 1.5 \text{ Vdc}$) ($V_{CE} = 60 \text{ Vdc}, V_{BE(off)} = 1.5 \text{ Vdc}, T_C = 125^\circ\text{C}$) ($V_{CE} = 80 \text{ Vdc}, V_{BE(off)} = 1.5 \text{ Vdc}, T_C = 125^\circ\text{C}$)	2N5194 2N5195 2N5194 2N5195	I_{CEX}	— — — —	0.1 0.1 2.0 2.0	mAdc
Collector Cutoff Current ($V_{CB} = 60 \text{ Vdc}, I_E = 0$) ($V_{CB} = 80 \text{ Vdc}, I_E = 0$)	2N5194 2N5195	I_{CBO}	— —	0.1 0.1	mAdc
Emitter Cutoff Current ($V_{BE} = 5.0 \text{ Vdc}, I_C = 0$)		I_{EBO}	—	1.0	mAdc

(continued)

Preferred devices are Motorola recommended choices for future use and best overall value.

REV 7

© Motorola, Inc. 1995



MOTOROLA

www.DataSheet4U.com

www.DataSheet4U.com

2N5194 2N5195***ELECTRICAL CHARACTERISTICS** — continued ($T_C = 25^\circ\text{C}$ unless otherwise noted)

Characteristic	Symbol	Min	Max	Unit
ON CHARACTERISTICS				
DC Current Gain (1) ($I_C = 1.5 \text{ Adc}$, $V_{CE} = 2.0 \text{ Vdc}$)	h_{FE}	25	100	—
		20	80	
($I_C = 4.0 \text{ Adc}$, $V_{CE} = 2.0 \text{ Vdc}$)		10	—	
		7.0	—	
Collector–Emitter Saturation Voltage (1) ($I_C = 1.5 \text{ Adc}$, $I_B = 0.15 \text{ Adc}$) ($I_C = 4.0 \text{ Adc}$, $I_B = 1.0 \text{ Adc}$)	$V_{CE(\text{sat})}$	—	0.6 1.4	Vdc
Base–Emitter On Voltage (1) ($I_C = 1.5 \text{ Adc}$, $V_{CE} = 2.0 \text{ Vdc}$)	$V_{BE(\text{on})}$	—	1.2	Vdc
DYNAMIC CHARACTERISTICS				
Current–Gain — Bandwidth Product ($I_C = 1.0 \text{ Adc}$, $V_{CE} = 10 \text{ Vdc}$, $f = 1.0 \text{ MHz}$)	f_T	2.0	—	MHz

* Indicates JEDEC Registered Data.

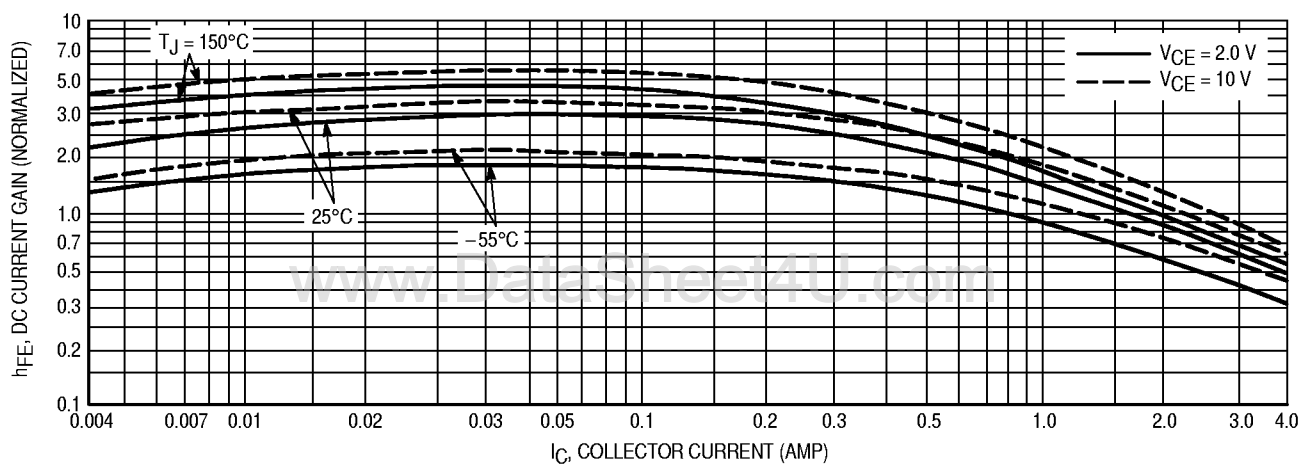
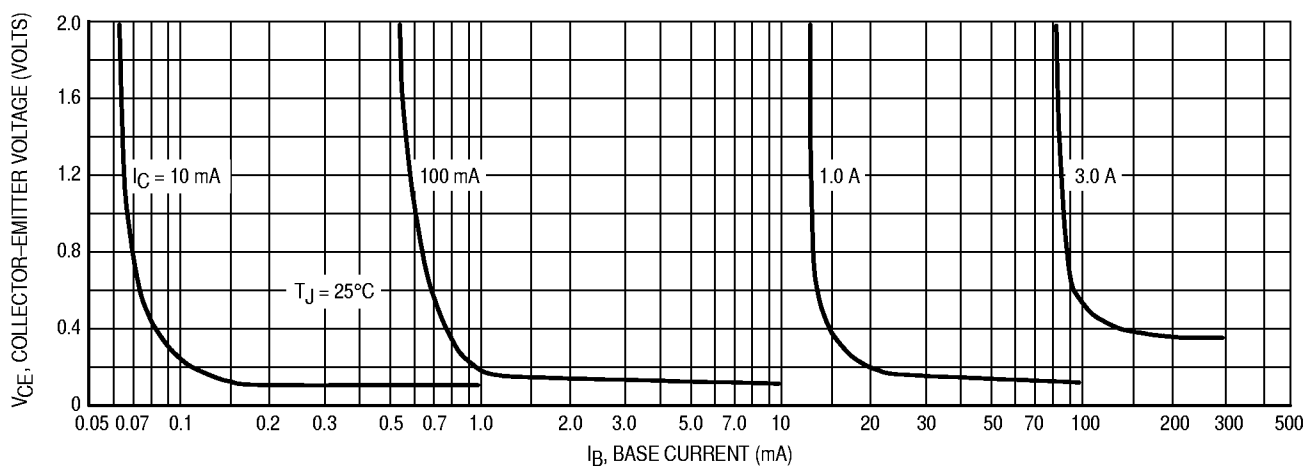
(1) Pulse Test: Pulse Width $\leq 300 \mu\text{s}$, Duty Cycle $\leq 2.0\%$.**Figure 1. DC Current Gain****Figure 2. Collector Saturation Region**

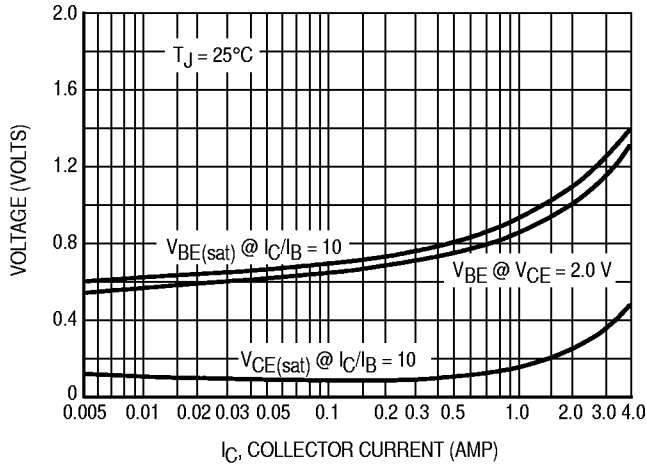

Figure 3. "On" Voltage

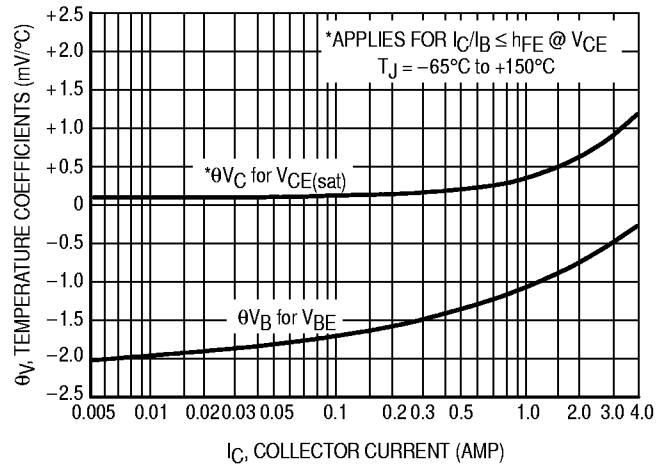

Figure 4. Temperature Coefficients

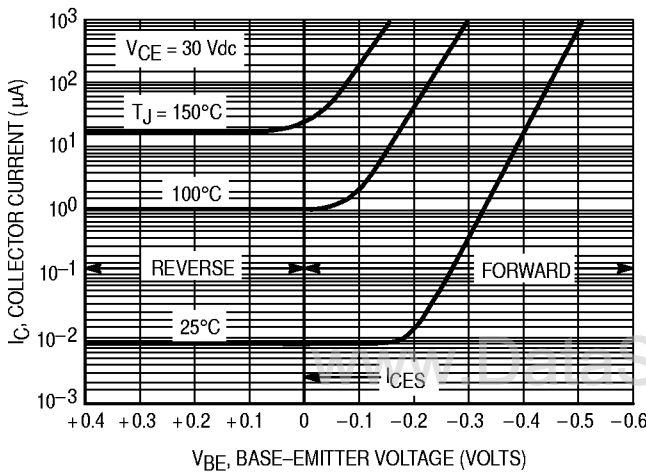

Figure 5. Collector Cut-Off Region

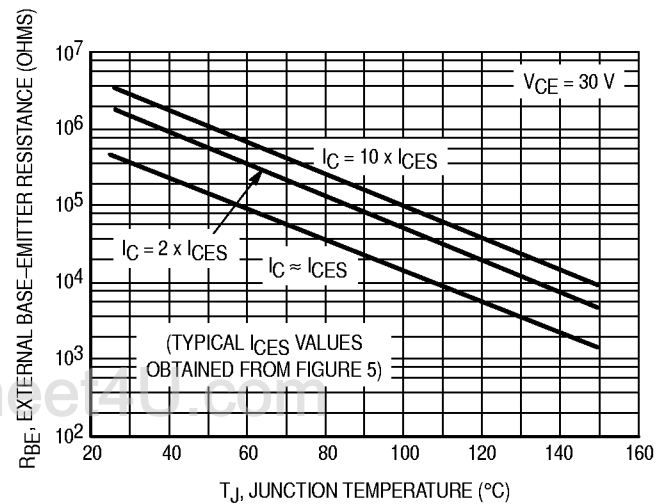

Figure 6. Effects of Base-Emitter Resistance

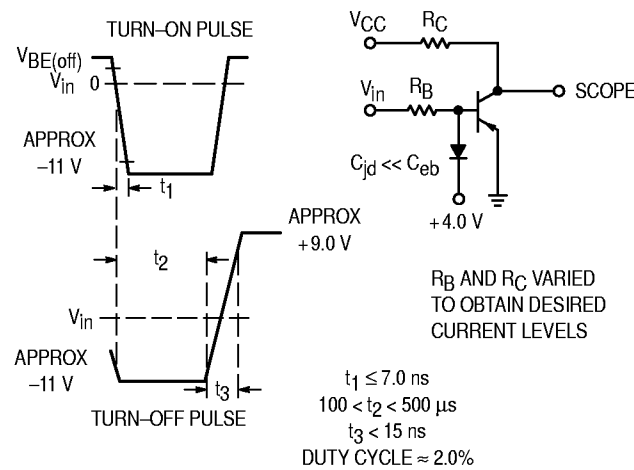

Figure 7. Switching Time Equivalent Test Circuit

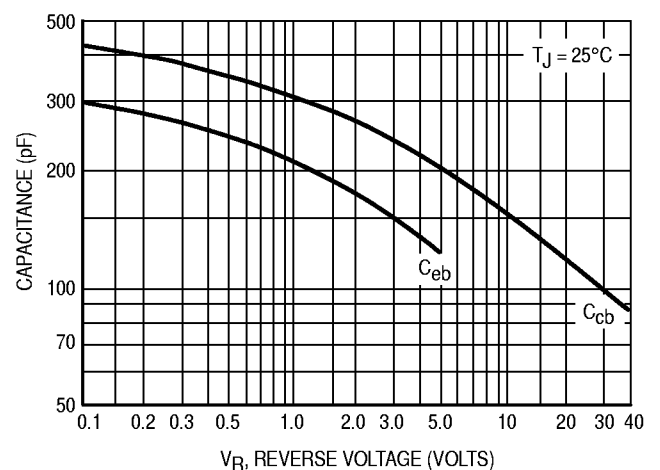

Figure 8. Capacitance

2N5194 2N5195

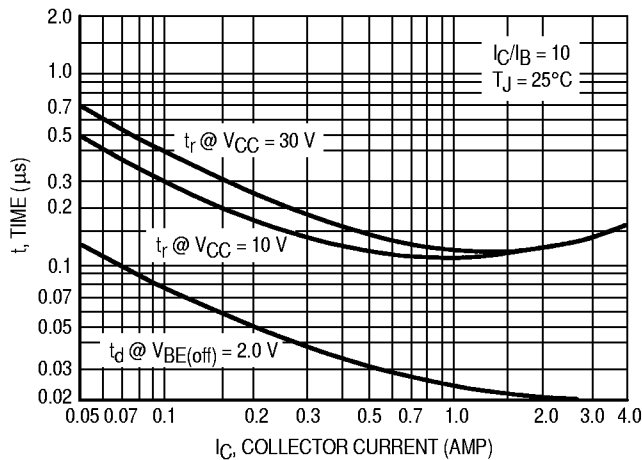

Figure 9. Turn-On Time

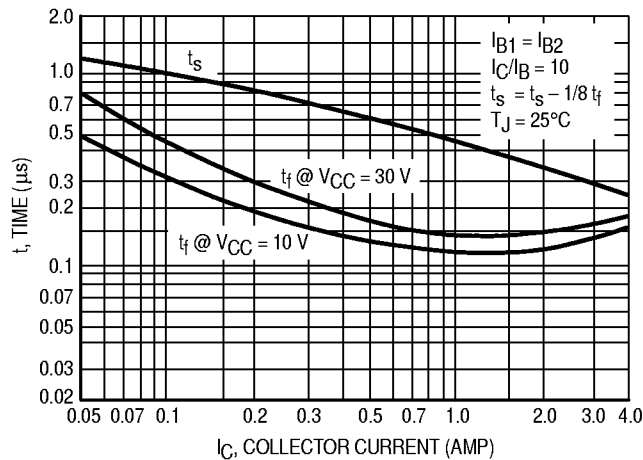

Figure 10. Turn-Off Time

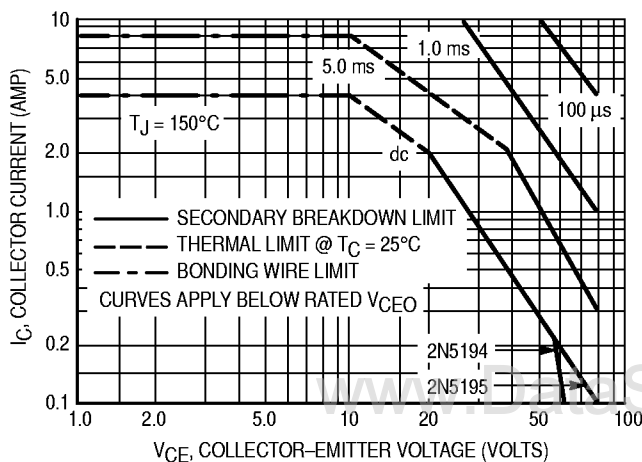

Figure 11. Rating and Thermal Data Active-Region Safe Operating Area

Note 1:

There are two limitations on the power handling ability of a transistor; average junction temperature and second breakdown. Safe operating area curves indicate $I_C - V_{CE}$ limits of the transistor that must be observed for reliable operation; i.e., the transistor must not be subjected to greater dissipation than the curves indicate.

The data of Figure 11 is based on $T_{J(pk)} = 150^\circ\text{C}$. T_C is variable depending on conditions. Second breakdown pulse limits are valid for duty cycles to 10% provided $T_{J(pk)} \leq 150^\circ\text{C}$. At high-case temperatures, thermal limitations will reduce the power that can be handled to values less than the limitations imposed by second breakdown.

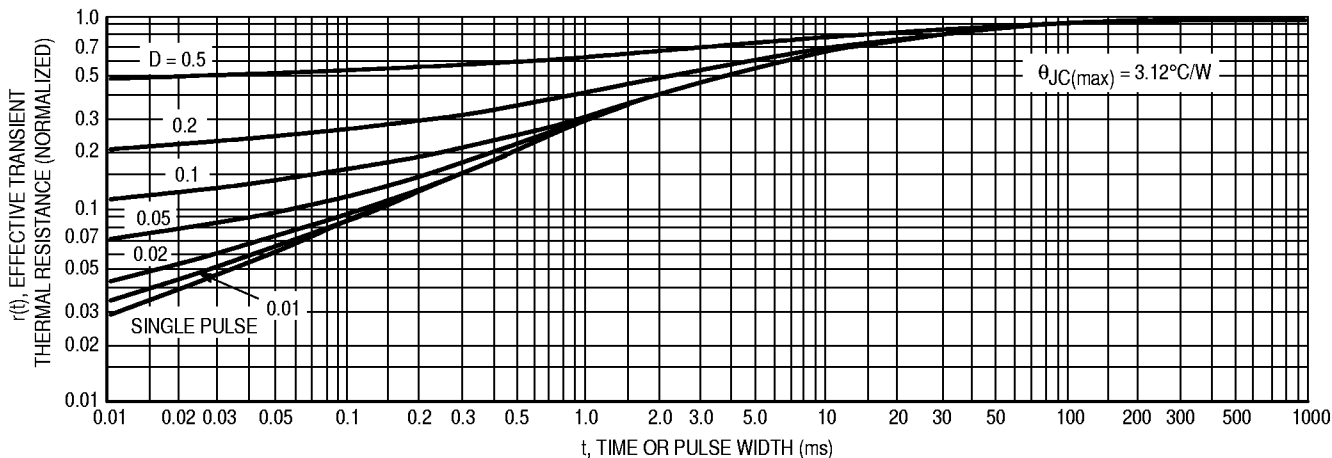

Figure 12. Thermal Response

DESIGN NOTE: USE OF TRANSIENT THERMAL RESISTANCE DATA

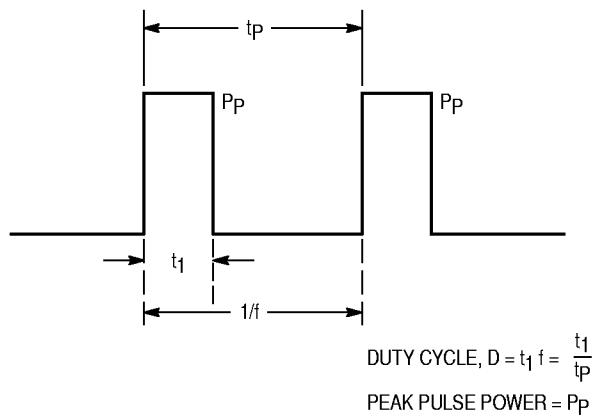

Figure A

A train of periodical power pulses can be represented by the model shown in Figure A. Using the model and the device thermal response, the normalized effective transient thermal resistance of Figure 12 was calculated for various duty cycles.

To find $\theta_{JC}(t)$, multiply the value obtained from Figure 12 by the steady state value θ_{JC} .

Example:

The 2N5193 is dissipating 50 watts under the following conditions: $t_1 = 0.1$ ms, $t_p = 0.5$ ms. ($D = 0.2$).

Using Figure 12, at a pulse width of 0.1 ms and $D = 0.2$, the reading of $r(t_1, D)$ is 0.27.

The peak rise in junction temperature is therefore:

$$\Delta T = r(t) \times P_p \times \theta_{JC} = 0.27 \times 50 \times 3.12 = 42.2^\circ\text{C}$$

2N5194 2N5195

PACKAGE DIMENSIONS

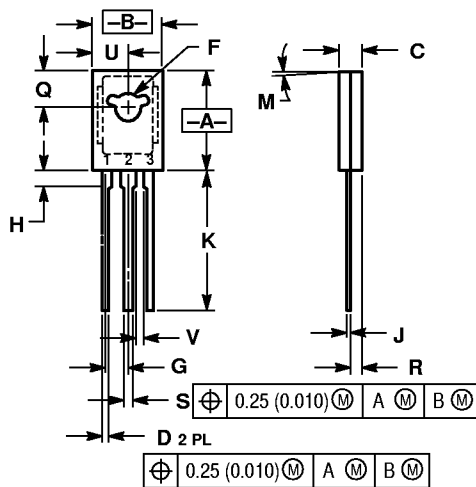

NOTES:

- DIMENSIONING AND TOLERANCING PER ANSI Y14.5M, 1982.
- CONTROLLING DIMENSION: INCH.

DIM	INCHES		MILLIMETERS	
	MIN	MAX	MIN	MAX
A	0.425	0.435	10.80	11.04
B	0.295	0.305	7.50	7.74
C	0.095	0.105	2.42	2.66
D	0.020	0.026	0.51	0.66
F	0.115	0.130	2.93	3.30
G	0.094	BSC	2.39	BSC
H	0.050	0.095	1.27	2.41
J	0.015	0.025	0.39	0.63
K	0.575	0.655	14.61	16.63
M	5° TYP		5° TYP	
Q	0.148	0.158	3.76	4.01
R	0.045	0.055	1.15	1.39
S	0.025	0.035	0.64	0.88
U	0.145	0.155	3.69	3.93
V	0.040	—	1.02	—

STYLE 1:

- EMITTER
- COLLECTOR
- BASE

www.DataSheet4U.com
CASE 77-08
TO-225AA TYPE
ISSUE V

Motorola reserves the right to make changes without further notice to any products herein. Motorola makes no warranty, representation or guarantee regarding the suitability of its products for any particular purpose, nor does Motorola assume any liability arising out of the application or use of any product or circuit, and specifically disclaims any and all liability, including without limitation consequential or incidental damages. "Typical" parameters can and do vary in different applications. All operating parameters, including "Typicals" must be validated for each customer application by customer's technical experts. Motorola does not convey any license under its patent rights nor the rights of others. Motorola products are not designed, intended, or authorized for use as components in systems intended for surgical implant into the body, or other applications intended to support or sustain life, or for any other application in which the failure of the Motorola product could create a situation where personal injury or death may occur. Should Buyer purchase or use Motorola products for any such unintended or unauthorized application, Buyer shall indemnify and hold Motorola and its officers, employees, subsidiaries, affiliates, and distributors harmless against all claims, costs, damages, and expenses, and reasonable attorney fees arising out of, directly or indirectly, any claim of personal injury or death associated with such unintended or unauthorized use, even if such claim alleges that Motorola was negligent regarding the design or manufacture of the part. Motorola and (M) are registered trademarks of Motorola, Inc. Motorola, Inc. is an Equal Opportunity/Affirmative Action Employer.

How to reach us:

USA / EUROPE: Motorola Literature Distribution;
P.O. Box 20912, Phoenix, Arizona 85036. 1-800-441-2447

MFAX: RMFAX0@email.sps.mot.com - TOUCHTONE (602) 244-6609
INTERNET: http://Design-NET.com

JAPAN: Nippon Motorola Ltd.; Tatsumi-SPD-JLDC, Toshikatsu Otsuki,
6F Seibu-Butsuryu-Center, 3-14-2 Tatsumi Koto-Ku, Tokyo 135, Japan. 03-3521-8315

HONG KONG: Motorola Semiconductors H.K. Ltd.; 8B Tai Ping Industrial Park,
51 Ting Kok Road, Tai Po, N.T., Hong Kong. 852-26629298

www.DataSheet4U.com



2N5194/D

