

2N5463, 2N5464, 2N5465 P-Channel JFET

Features

- InterFET [P0032F Geometry](#)
- Typical Noise: 2.7 nV/√Hz
- Low Ciss: 3.2pF Typical
- RoHS Compliant
- SMT, TH, and Bare Die Package options.

Applications

- Audio Amplifiers
- Small Signal Amplifiers
- General Purpose Amplifier

Description

The 60V InterFET 2N5463, 2N5464, and 2N5465 are targeted for low noise small signal amplifiers and audio amplifiers. Gate leakages are typically less than 10pA at room temperatures.

SOT23 Top View

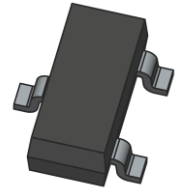
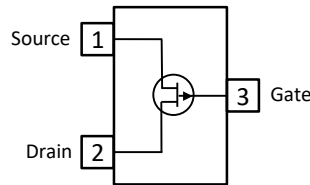

TO-92 Bottom View

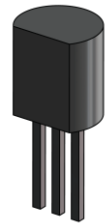
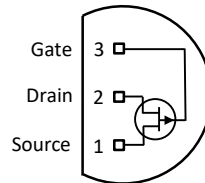

Product Summary

Parameters	2N5463 Min	2N5464 Min	2N5465 Min	Unit
BV_{GSS} Gate to Source Breakdown Voltage	60	60	60	V
I_{DSS} Drain to Source Saturation Current	-1	-2	-4	mA
$V_{GS(off)}$ Gate to Source Cutoff Voltage	0.75	1	1.8	V
G_{FS} Forward Transconductance	1	1.5	2	mS

Ordering Information Custom Part and Binning Options Available

Part Number	Description	Case	Packaging
2N5463; 2N5464; 2N5465	Through-Hole	TO-92	Bulk
SMP5463; SMP5464; SMP5465	Surface Mount	SOT23	Bulk
SMP5463TR; SMP5464TR; SMP5465TR	7" Tape and Reel: Max 3,000 Pieces 13" Tape and Reel: Max 9,000 Pieces	SOT23	Minimum 1,000 Pieces Tape and Reel
2N5463COT; 2N5464COT; 2N5465COT	Chip Orientated Tray (COT Waffle Pack)	COT	400/Waffle Pack
2N5463CFT; 2N5464CFT; 2N5465CFT	Chip Face-up Tray (CFT Waffle Pack)	CFT	400/Waffle Pack



Disclaimer: It is the Buyers responsibility for designing, validating and testing the end application under all field use cases and extreme use conditions. Guaranteeing the application meets required standards, regulatory compliance, and all safety and security requirements is the responsibility of the Buyer. These resources are subject to change without notice.

Electrical Characteristics

Maximum Ratings (@ $T_A = 25^\circ\text{C}$, Unless otherwise specified)

Parameters	Value	Unit
V_{RGS} Reverse Gate Source and Gate Drain Voltage	60	V
I_{FG} Continuous Forward Gate Current	-10	mA
P_D Continuous Device Power Dissipation	310	mW
P Power Derating	2.8	mW/ $^\circ\text{C}$
T_J Operating Junction Temperature	-55 to 125	$^\circ\text{C}$
T_{STG} Storage Temperature	-65 to 150	$^\circ\text{C}$

Static Characteristics (@ $T_A = 25^\circ\text{C}$, Unless otherwise specified)

Parameters	Conditions	2N5463		2N5464		2N5465		Unit
		Min	Max	Min	Max	Min	Max	
$V_{(BR)GSS}$ Gate to Source Breakdown Voltage	$V_{DS} = 0V, I_G = 10\mu\text{A}$	60		60		60		V
I_{GSS} Gate to Source Reverse Current	$V_{GS} = 30V, V_{DS} = 0V, T_A = 25^\circ\text{C}$ $V_{GS} = 30V, V_{DS} = 0V, T_A = 100^\circ\text{C}$		5 1		5 1		5 1	nA μA
$V_{GS(OFF)}$ Gate to Source Cutoff Voltage	$V_{DS} = 15V, I_D = 1\mu\text{A}$	0.75	6	1	7.5	1.8	9	V
V_{GS} Gate to Source Voltage	$V_{DS} = -15V, I_D = ()$	0.5 (-100)	4.0 (-100)	0.8 (-200)	4.5 (-200)	1.5 (-400)	6 (-400)	V μA
I_{DSS} Drain to Source Saturation Current	$V_{DS} = -15V, V_{GS} = 0V$ (Pulsed)	-1	-5	-2	-9	-4	-16	mA

Dynamic Characteristics (@ $T_A = 25^\circ\text{C}$, Unless otherwise specified)

Parameters	Conditions	2N5463		2N5464		2N5465		Unit
		Min	Max	Min	Max	Min	Max	
G_{FS} Forward Transconductance	$V_{DS} = -15V, V_{GS} = 0V, f = 1\text{kHz}$	1	4	1.5	5	2	6	mS
G_{OS} Output Conductance	$V_{DS} = -15V, V_{GS} = 0V, f = 1\text{kHz}$		75		75		75	μS
C_{iss} Input Capacitance	$V_{DS} = -15V, V_{GS} = 0V, f = 1\text{MHz}$		7		7		7	pF
C_{rss} Reverse Transfer Capacitance	$V_{DS} = -15V, V_{GS} = 0V, f = 1\text{MHz}$		2		2		2	pF
NF Noise Figure	$V_{DS} = -15V, V_{GS} = 0V, f = 100\text{Hz}$, BW = 1Hz		2.5		2.5		2.5	dB
e_n Equivalent Circuit Input Noise Voltage	$V_{DS} = -15V, V_{GS} = 0V, f = 100\text{Hz}$, $R_G = 1\text{M}\Omega$		115		115		115	nV/ $\sqrt{\text{Hz}}$

SOT23 (TO-236AB) Mechanical and Layout Data

Package Outline Data

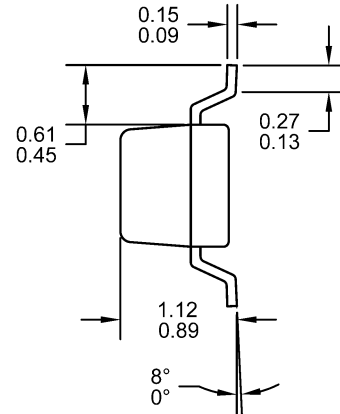

1. All linear dimensions are in millimeters.
2. Package weight approximately 0.12 grams
3. Molded plastic case UL 94V-0 rated
4. For Tape and Reel specifications refer to InterFET CTC-021 Tape and Reel Specification, Document number: IF39002
5. Bulk product is shipped in standard ESD shipping material
6. Refer to JEDEC standards for additional information.

Suggested Pad Layout



1. All linear dimensions are in millimeters.
2. The suggested land pattern dimensions have been provided for reference only. A more robust pattern may be desired for wave soldering.

TO-92 Mechanical and Layout Data

Package Outline Data

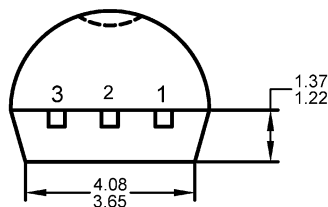
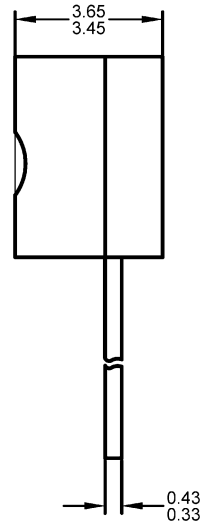
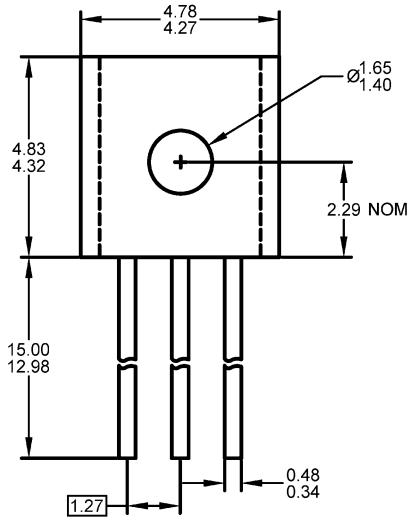

1. All linear dimensions are in millimeters.
2. Package weight approximately 0.19 grams
3. Molded plastic case UL 94V-0 rated
4. Bulk product is shipped in standard ESD shipping material
5. Refer to JEDEC standards for additional information.

Suggested Through-Hole Layout

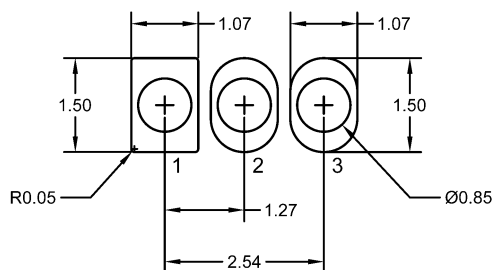

1. All linear dimensions are in millimeters.
2. The suggested land pattern dimensions have been provided as a straight lead reference only. A more robust pattern may be desired for wave soldering and/or bent lead configurations.