

JFET VHF/UHF Amplifiers

N-Channel — Depletion

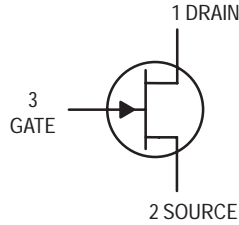

2N5484
2N5486

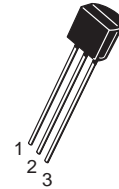

CASE 29-04, STYLE 5
TO-92 (TO-226AA)

MAXIMUM RATINGS

Rating	Symbol	Value	Unit
Drain–Gate Voltage	V_{DG}	25	Vdc
Reverse Gate–Source Voltage	V_{GSR}	25	Vdc
Drain Current	I_D	30	mAdc
Forward Gate Current	$I_{G(f)}$	10	mAdc
Total Device Dissipation @ $T_C = 25^\circ\text{C}$ Derate above 25°C	P_D	350 2.8	mW mW/ $^\circ\text{C}$
Operating and Storage Junction Temperature Range	T_J, T_{stg}	-65 to +150	$^\circ\text{C}$

ELECTRICAL CHARACTERISTICS ($T_A = 25^\circ\text{C}$ unless otherwise noted)

Characteristic	Symbol	Min	Typ	Max	Unit
----------------	--------	-----	-----	-----	------

OFF CHARACTERISTICS

Gate–Source Breakdown Voltage ($I_G = -1.0 \mu\text{Adc}$, $V_{DS} = 0$)	$V_{(BR)GSS}$	-25	—	—	Vdc
Gate Reverse Current ($V_{GS} = -20 \text{ Vdc}$, $V_{DS} = 0$) ($V_{GS} = -20 \text{ Vdc}$, $V_{DS} = 0$, $T_A = 100^\circ\text{C}$)	I_{GSS}	— —	— —	-1.0 -0.2	nAdc μAdc
Gate Source Cutoff Voltage ($V_{DS} = 15 \text{ Vdc}$, $I_D = 10 \text{ nAdc}$)	$V_{GS(off)}$	2N5484 2N5486	— —	-0.3 -2.0	Vdc

ON CHARACTERISTICS

Zero–Gate–Voltage Drain Current ($V_{DS} = 15 \text{ Vdc}$, $V_{GS} = 0$)	2N5484 2N5486	I_{DSS}	1.0 8.0	— —	5.0 20	mAdc
---	------------------	-----------	------------	--------	-----------	------

SMALL-SIGNAL CHARACTERISTICS

Forward Transfer Admittance ($V_{DS} = 15 \text{ Vdc}$, $V_{GS} = 0$, $f = 1.0 \text{ kHz}$)	2N5484 2N5486	$ y_{fs} $	3000 4000	— —	6000 8000	μhos
Input Admittance ($V_{DS} = 15 \text{ Vdc}$, $V_{GS} = 0$, $f = 100 \text{ MHz}$) ($V_{DS} = 15 \text{ Vdc}$, $V_{GS} = 0$, $f = 400 \text{ MHz}$)	2N5484 2N5486	$\text{Re}(y_{is})$	— —	— —	100 1000	μhos
Output Admittance ($V_{DS} = 15 \text{ Vdc}$, $V_{GS} = 0$, $f = 1.0 \text{ kHz}$)	2N5484 2N5486	$ y_{os} $	— —	— —	50 75	μhos
Output Conductance ($V_{DS} = 15 \text{ Vdc}$, $V_{GS} = 0$, $f = 100 \text{ MHz}$) ($V_{DS} = 15 \text{ Vdc}$, $V_{GS} = 0$, $f = 400 \text{ MHz}$)	2N5484 2N5486	$\text{Re}(y_{os})$	— —	— —	75 100	μhos
Forward Transconductance ($V_{DS} = 15 \text{ Vdc}$, $V_{GS} = 0$, $f = 100 \text{ MHz}$) ($V_{DS} = 15 \text{ Vdc}$, $V_{GS} = 0$, $f = 400 \text{ MHz}$)	2N5484 2N5486	$\text{Re}(y_{fs})$	2500 3500	— —	— —	μhos

ELECTRICAL CHARACTERISTICS ($T_A = 25^\circ\text{C}$ unless otherwise noted) (Continued)

Characteristic	Symbol	Min	Typ	Max	Unit
SMALL-SIGNAL CHARACTERISTICS (continued)					
Input Capacitance ($V_{DS} = 15\text{ Vdc}$, $V_{GS} = 0$, $f = 1.0\text{ MHz}$)	C_{iss}	—	—	5.0	pF
Reverse Transfer Capacitance ($V_{DS} = 15\text{ Vdc}$, $V_{GS} = 0$, $f = 1.0\text{ MHz}$)	C_{rss}	—	—	1.0	pF
Output Capacitance ($V_{DS} = 15\text{ Vdc}$, $V_{GS} = 0$, $f = 1.0\text{ MHz}$)	C_{oss}	—	—	2.0	pF

FUNCTIONAL CHARACTERISTICS

Noise Figure ($V_{DS} = 15\text{ Vdc}$, $V_{GS} = 0$, $R_G = 1.0\text{ Megohm}$, $f = 1.0\text{ kHz}$)		NF	—	—	2.5	dB
($V_{DS} = 15\text{ Vdc}$, $I_D = 1.0\text{ mAdc}$, $R_G \approx 1.0\text{ k}\Omega$, $f = 100\text{ MHz}$)	2N5484		—	—	3.0	
($V_{DS} = 15\text{ Vdc}$, $I_D = 1.0\text{ mAdc}$, $R_G \approx 1.0\text{ k}\Omega$, $f = 200\text{ MHz}$)	2N5484		—	4.0	—	
($V_{DS} = 15\text{ Vdc}$, $I_D = 4.0\text{ mAdc}$, $R_G \approx 1.0\text{ k}\Omega$, $f = 100\text{ MHz}$)	2N5486		—	—	2.0	
($V_{DS} = 15\text{ Vdc}$, $I_D = 4.0\text{ mAdc}$, $R_G \approx 1.0\text{ k}\Omega$, $f = 400\text{ MHz}$)	2N5486		—	—	4.0	
Common Source Power Gain		G_{ps}				dB
($V_{DS} = 15\text{ Vdc}$, $I_D = 1.0\text{ mAdc}$, $f = 100\text{ MHz}$)	2N5484		16	—	25	
($V_{DS} = 15\text{ Vdc}$, $I_D = 1.0\text{ mAdc}$, $f = 200\text{ MHz}$)	2N5484		—	14	—	
($V_{DS} = 15\text{ Vdc}$, $I_D = 4.0\text{ mAdc}$, $f = 100\text{ MHz}$)	2N5486		18	—	30	
($V_{DS} = 15\text{ Vdc}$, $I_D = 4.0\text{ mAdc}$, $f = 400\text{ MHz}$)	2N5486		10	—	20	

POWER GAIN

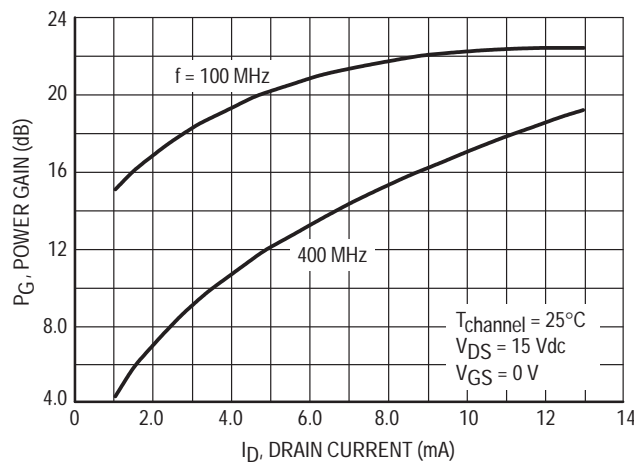
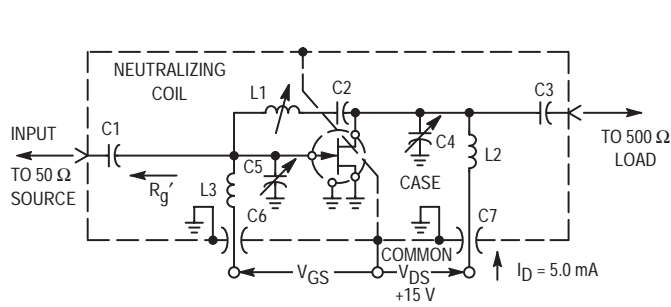

Figure 1. Effects of Drain Current



Adjust V_{GS} for $I_D = 50 \text{ mA}$
 $V_{GS} < 0 \text{ Volts}$

NOTE: The noise source is a hot-cold body (AIL type 70 or equivalent) with a test receiver (AIL type 136 or equivalent).

Reference Designation	VALUE	
	100 MHz	400 MHz
C1	7.0 pF	1.8 pF
C2	1000 pF	17 pF
C3	3.0 pF	1.0 pF
C4	1–12 pF	0.8–8.0 pF
C5	1–12 pF	0.8–8.0 pF
C6	0.0015 μF	0.001 μF
C7	0.0015 μF	0.001 μF
L1	3.0 μH^*	0.2 μH^{**}
L2	0.15 μH^*	0.03 μH^{**}
L3	0.14 μH^*	0.022 μH^{**}

- *L1 17 turns, (approx. — depends upon circuit layout) AWG #28 enameled copper wire, close wound on 9/32" ceramic coil form. Tuning provided by a powdered iron slug.
- L2 4–1/2 turns, AWG #18 enameled copper wire, 5/16" long, 3/8" I.D. (AIR CORE).
- L3 3–1/2 turns, AWG #18 enameled copper wire, 1/4" long, 3/8" I.D. (AIR CORE).

- **L1 6 turns, (approx. — depends upon circuit layout) AWG #24 enameled copper wire, close wound on 7/32" ceramic coil form. Tuning provided by an aluminum slug.
- L2 1 turn, AWG #16 enameled copper wire, 3/8" I.D. (AIR CORE).
- L3 1/2 turn, AWG #16 enameled copper wire, 1/4" I.D. (AIR CORE).

Figure 2. 100 MHz and 400 MHz Neutralized Test Circuit

NOISE FIGURE
 ($T_{\text{channel}} = 25^\circ\text{C}$)

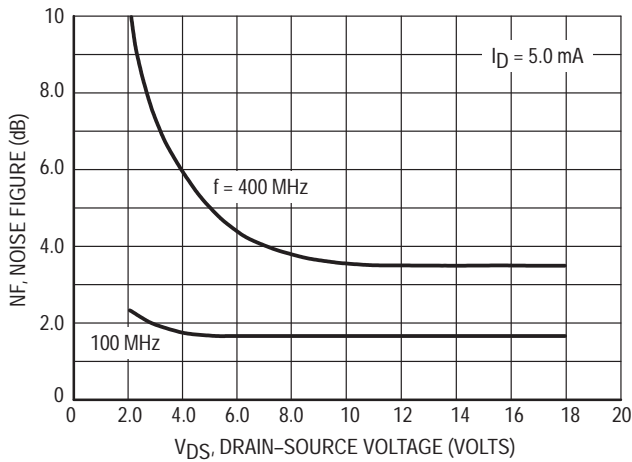

Figure 3. Effects of Drain-Source Voltage

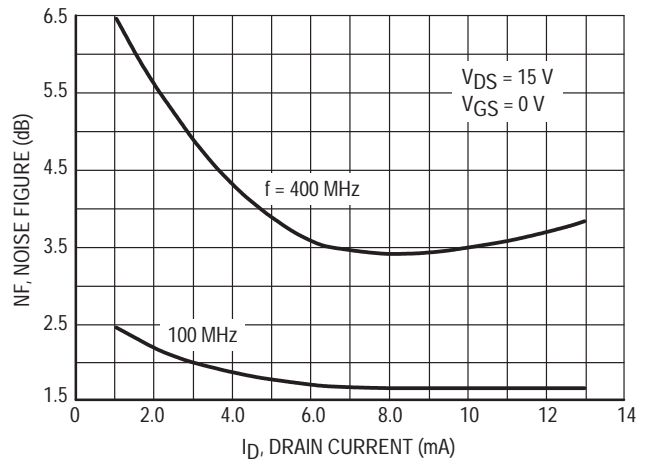

Figure 4. Effects of Drain Current

INTERMODULATION CHARACTERISTICS

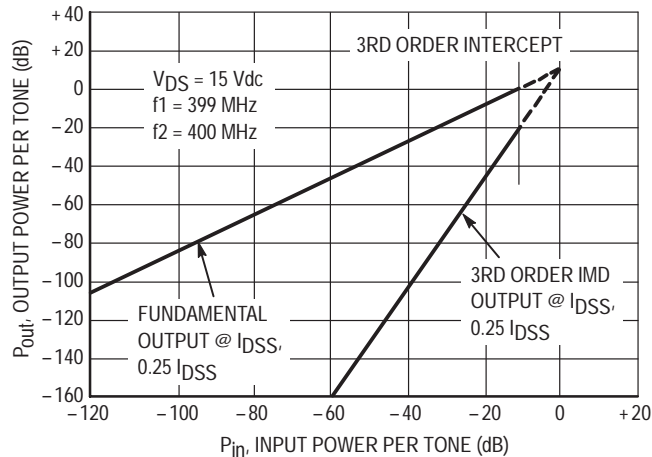

Figure 5. Third Order Intermodulation Distortion

COMMON SOURCE CHARACTERISTICS

ADMITTANCE PARAMETERS

($V_{DS} = 15 \text{ Vdc}$, $T_{channel} = 25^\circ\text{C}$)

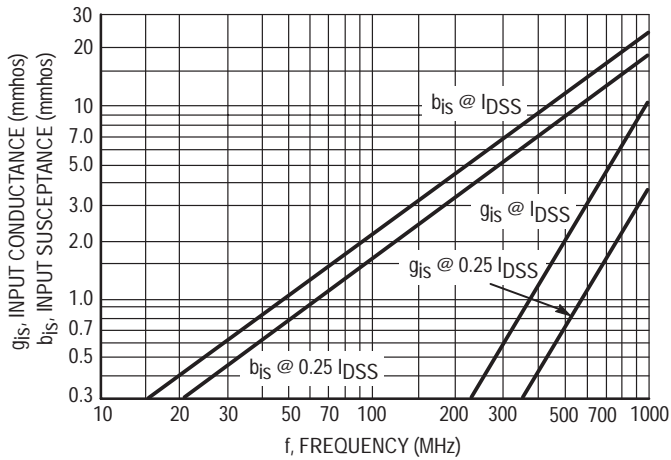

Figure 6. Input Admittance (y_{is})

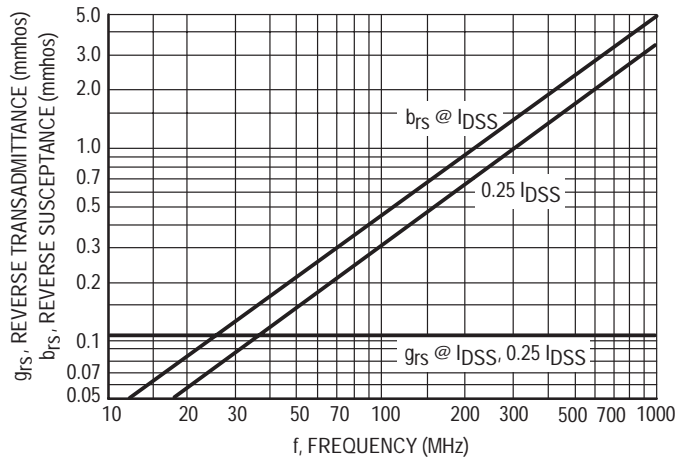

Figure 7. Reverse Transfer Admittance (y_{rs})

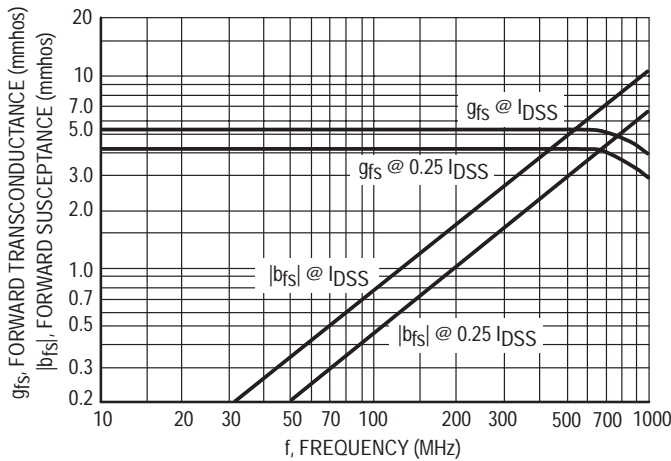

Figure 8. Forward Transadmittance (y_{fs})

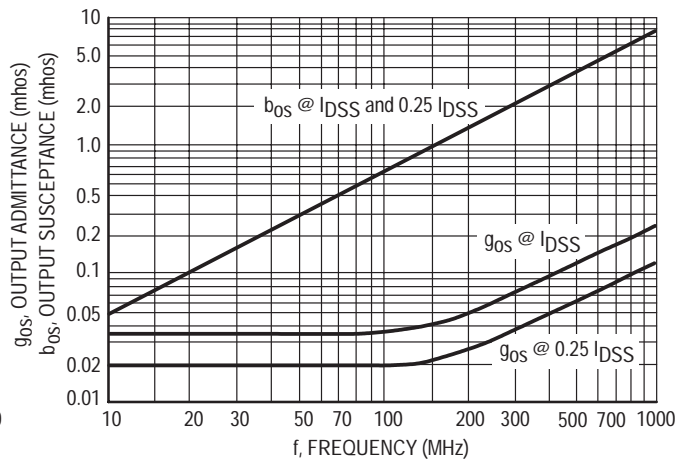

Figure 9. Output Admittance (y_{os})

COMMON SOURCE CHARACTERISTICS
S-PARAMETERS
 ($V_{DS} = 15 \text{ Vdc}$, $T_{\text{channel}} = 25^\circ\text{C}$, Data Points in MHz)

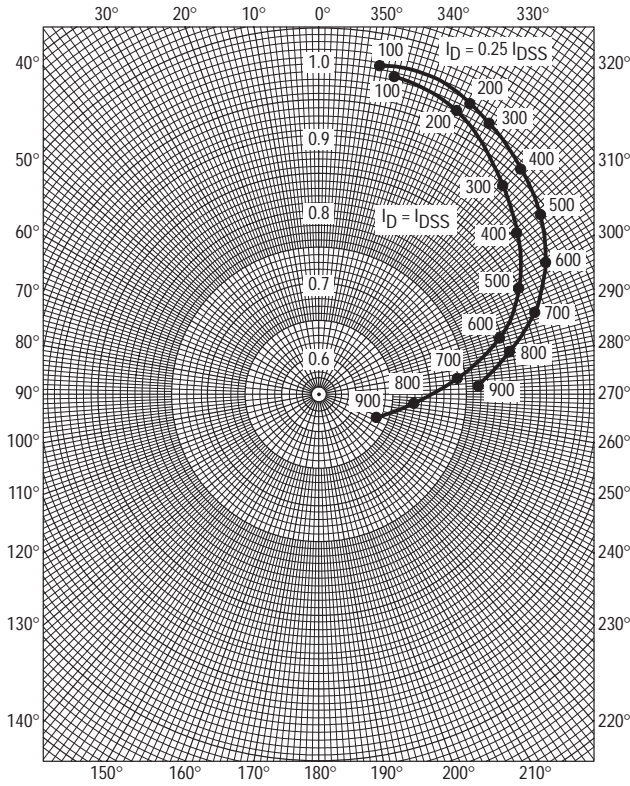

Figure 10. S_{11s}

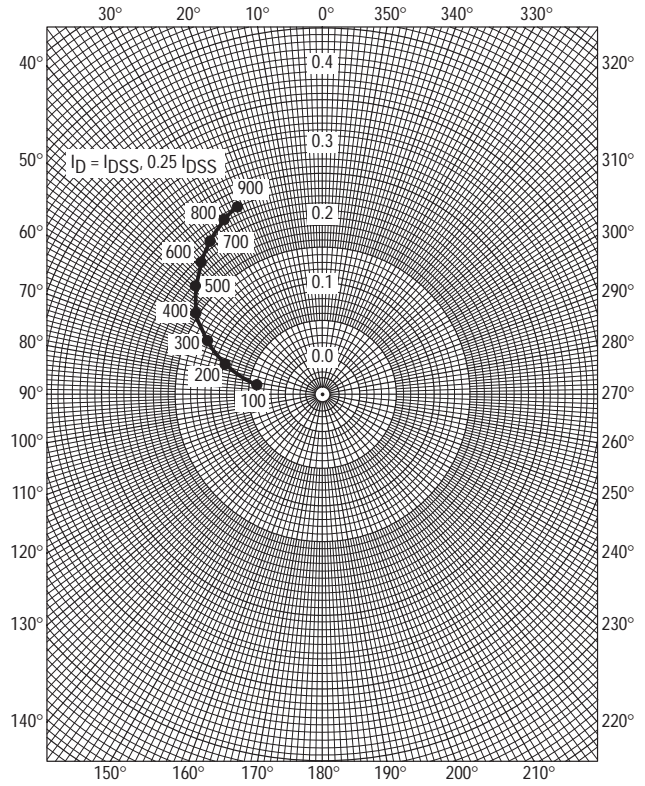

Figure 11. S_{12s}

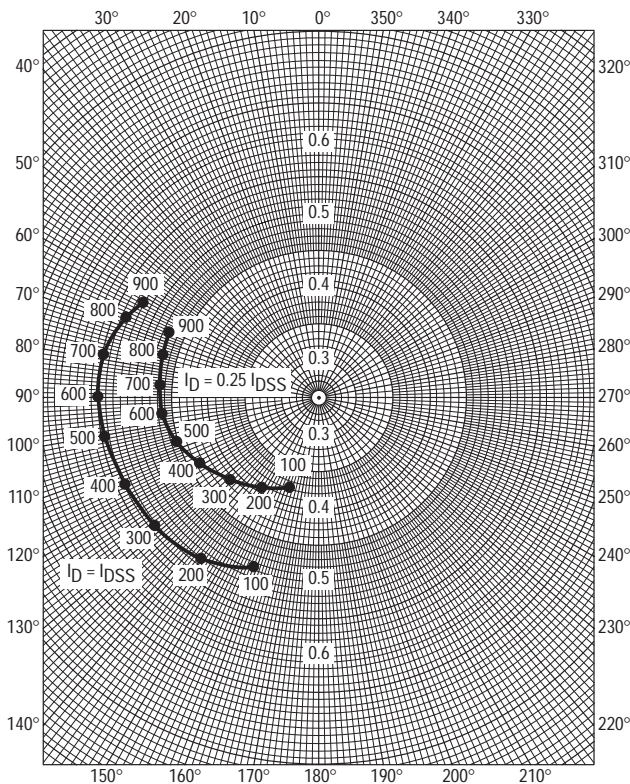

Figure 12. S_{21s}

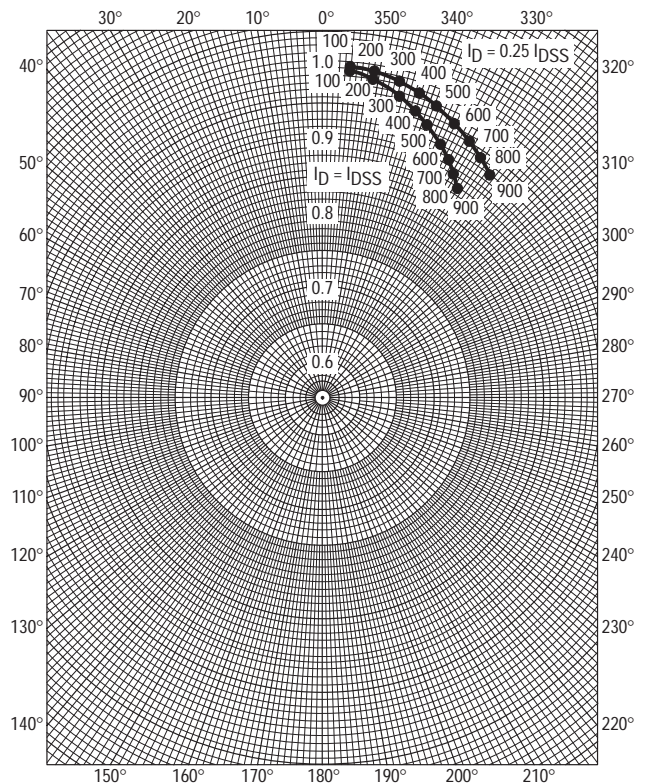

Figure 13. S_{22s}

COMMON GATE CHARACTERISTICS

ADMITTANCE PARAMETERS

($V_{DG} = 15 \text{ Vdc}$, $T_{channel} = 25^\circ\text{C}$)

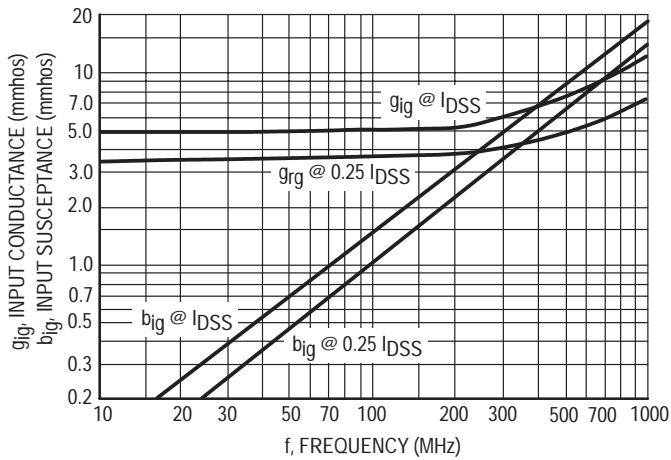

Figure 14. Input Admittance (y_{ig})

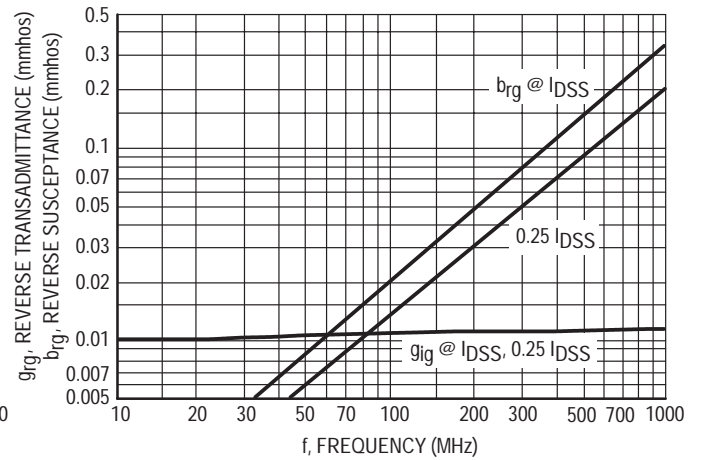

Figure 15. Reverse Transfer Admittance (y_{rg})

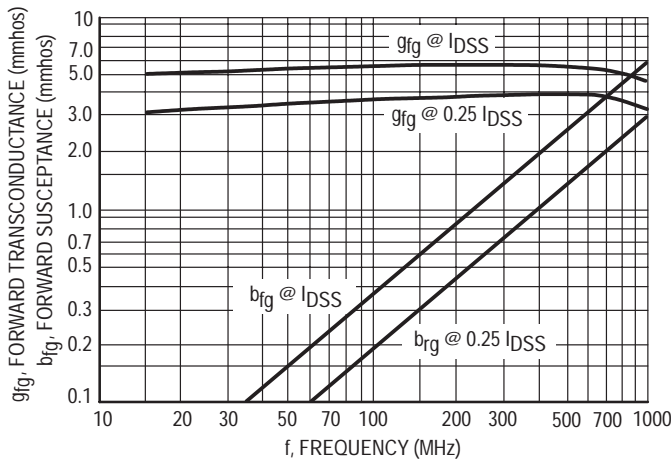

Figure 16. Forward Transfer Admittance (y_{fg})

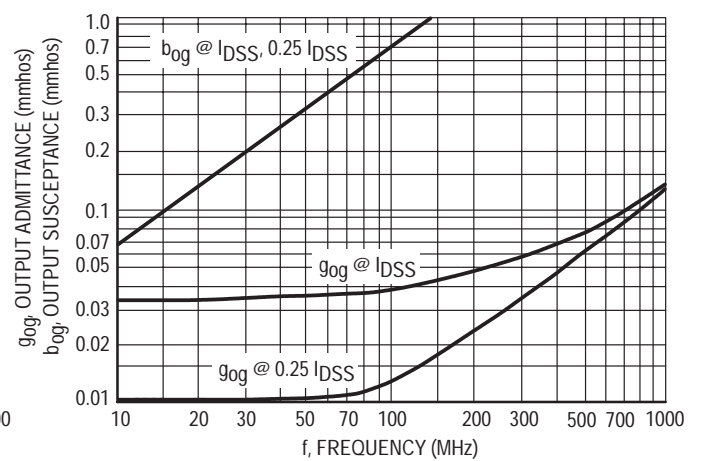

Figure 17. Output Admittance (y_{og})

COMMON GATE CHARACTERISTICS
S-PARAMETERS

($V_{DS} = 15 \text{ Vdc}$, $T_{channel} = 25^\circ\text{C}$, Data Points in MHz)

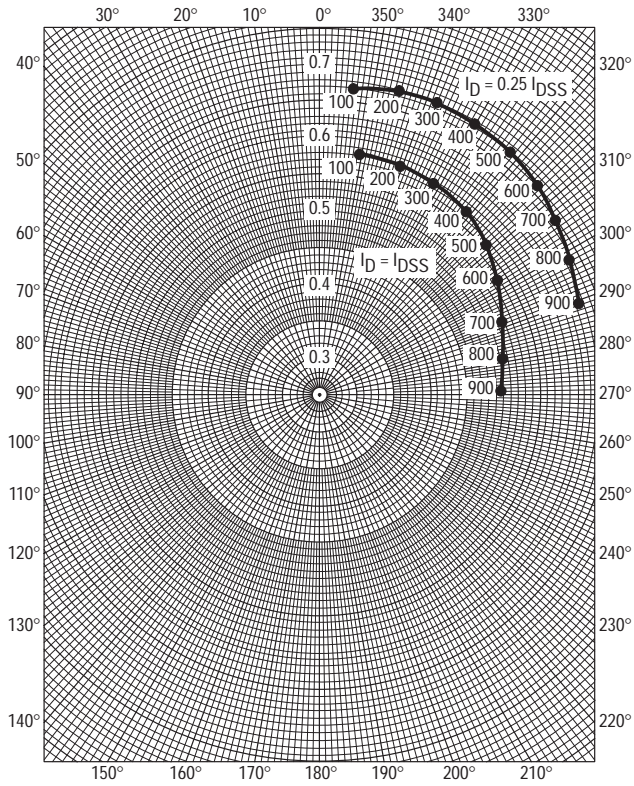

Figure 18. S_{11g}

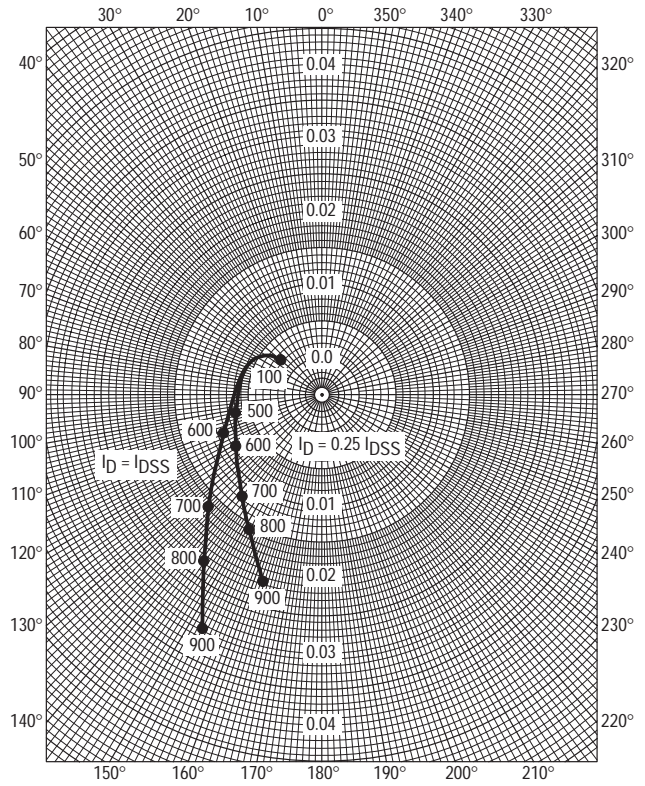

Figure 19. S_{12g}

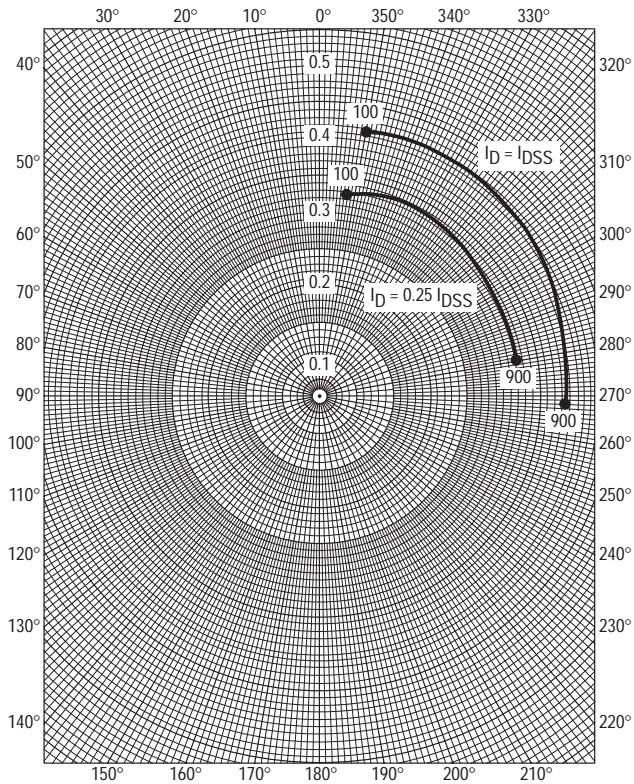

Figure 20. S_{21g}

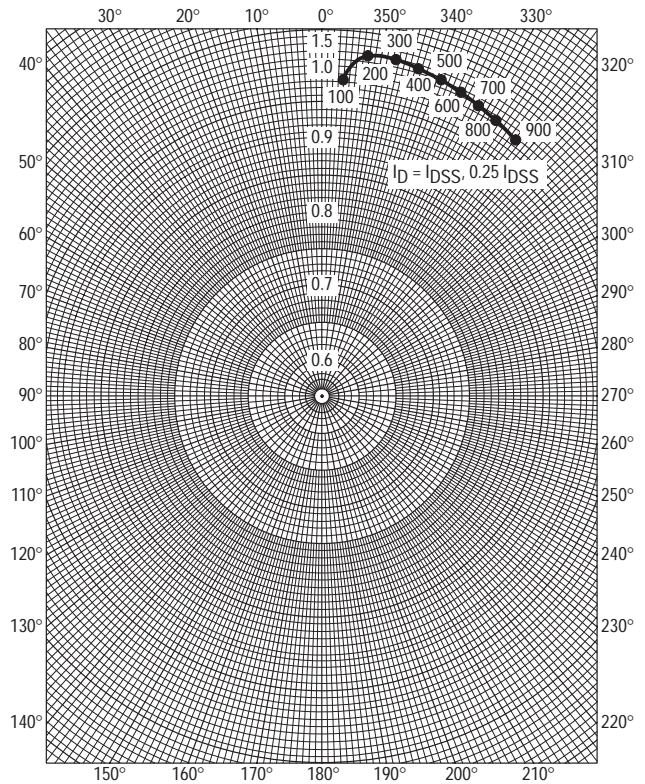

Figure 21. S_{22g}