

# 2N6344A, 2N6348A, 2N6349A

Preferred Device

## Triacs

### Silicon Bidirectional Thyristors

Designed primarily for full-wave AC control applications, such as light dimmers, motor controls, heating controls and power supplies; or wherever full-wave silicon gate controlled solid-state devices are needed. Triac type thyristors switch from a blocking to a conducting state for either polarity of applied anode voltage with positive or negative gate triggering.

#### Features

- Blocking Voltage to 800 V
- All Diffused and Glass Passivated Junctions for Greater Parameter Uniformity and Stability
- Small, Rugged, Thermowatt Construction for Low Thermal Resistance, High Heat Dissipation and Durability
- Gate Triggering Guaranteed in all Four Quadrants
- For 400 Hz Operation, Consult Factory
- 8.0 A Devices Available as 2N6344 thru 2N6349
- Pb-Free Packages are Available\*



**ON Semiconductor®**

<http://onsemi.com>

**TRIACS**  
**12 AMPERES RMS**  
**600 thru 800 VOLTS**

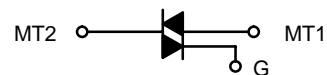

#### MARKING DIAGRAM

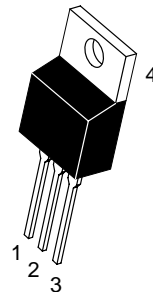

**TO-220AB**  
**CASE 221A**  
**STYLE 4**

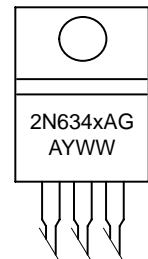

2N634xA = Device Code  
x = 4, 8, or 9  
A = Assembly Location  
Y = Year  
WW = Work Week  
G = Pb-Free Package

#### PIN ASSIGNMENT

PIN ASSIGNMENT	
1	Main Terminal 1
2	Main Terminal 2
3	Gate
4	Main Terminal 2

#### ORDERING INFORMATION

See detailed ordering and shipping information in the package dimensions section on page 2 of this data sheet.

**Preferred** devices are recommended choices for future use and best overall value.

\*For additional information on our Pb-Free strategy and soldering details, please download the ON Semiconductor Soldering and Mounting Techniques Reference Manual, SOLDERRM/D.

## 2N6344A, 2N6348A, 2N6349A

### MAXIMUM RATINGS

Characteristics	Symbol	Value	Unit
*Peak Repetitive Off-State Voltage (Note 1) (Gate Open, $T_J = -40$ to $+110^\circ\text{C}$ , Sine Wave 50 to 60 Hz, Gate Open) 2N6344A, 2N6348A 2N6349A	$V_{\text{DRM}}$ , $V_{\text{RRM}}$	600 800	V
*On-State RMS Current (Full Cycle Sine Wave 50 to 60 Hz)  ( $T_C = +80^\circ\text{C}$ ) ( $T_C = +95^\circ\text{C}$ )	$I_{\text{T(RMS)}}$	12 6.0	A
*Peak Non-repetitive Surge Current (One Full Cycle, 60 Hz, $T_C = +80^\circ\text{C}$ ) Preceded and followed by rated current	$I_{\text{TSM}}$	100	A
Circuit Fusing Consideration ( $t = 8.3$ ms)	$I^2t$	59	$\text{A}^2\text{s}$
*Peak Gate Power ( $T_C = +80^\circ\text{C}$ , Pulse Width = 2.0 $\mu\text{s}$ )	$P_{\text{GM}}$	20	W
*Average Gate Power ( $T_C = +80^\circ\text{C}$ , $t = 8.3$ ms)	$P_{\text{G(AV)}}$	0.5	W
*Peak Gate Current (Pulse Width = 2.0 $\mu\text{s}$ ; $T_C = +80^\circ\text{C}$ )	$I_{\text{GM}}$	2.0	A
*Peak Gate Voltage (Pulse Width = 2.0 $\mu\text{s}$ ; $T_C = +80^\circ\text{C}$ )	$V_{\text{GM}}$	$\pm 10$	V
*Operating Junction Temperature Range	$T_J$	-40 to +125	$^\circ\text{C}$
*Storage Temperature Range	$T_{\text{stg}}$	-40 to +150	$^\circ\text{C}$

Stresses exceeding Maximum Ratings may damage the device. Maximum Ratings are stress ratings only. Functional operation above the Recommended Operating Conditions is not implied. Extended exposure to stresses above the Recommended Operating Conditions may affect device reliability.

\*Indicates JEDEC Registered Data.

- $V_{\text{DRM}}$  and  $V_{\text{RRM}}$  for all types can be applied on a continuous basis. Blocking voltages shall not be tested with a constant current source such that the voltage ratings of the devices are exceeded.

### THERMAL CHARACTERISTICS

Characteristic	Symbol	Max	Unit
*Thermal Resistance, Junction-to-Case	$R_{\theta\text{JC}}$	2.0	$^\circ\text{C/W}$
Maximum Lead Temperature for Soldering Purposes 1/8" from Case for 10 Seconds	$T_L$	260	$^\circ\text{C}$

### ORDERING INFORMATION

Device	Package	Shipping
2N6344A	TO-220AB	500 Units / Box
2N6344AG	TO-220AB (Pb-Free)	
2N6348A	TO-220AB	
2N6348AG	TO-220AB (Pb-Free)	
2N6349A	TO-220AB	
2N6349AG	TO-220AB (Pb-Free)	

## 2N6344A, 2N6348A, 2N6349A

### ELECTRICAL CHARACTERISTICS ( $T_C = 25^\circ\text{C}$ unless otherwise noted; Electricals apply in either direction)

Characteristic	Symbol	Min	Typ	Max	Unit
----------------	--------	-----	-----	-----	------

#### OFF CHARACTERISTICS

*Peak Repetitive Blocking Current ( $V_D = \text{Rated } V_{DRM}, V_{RRM}: \text{Gate Open}$ )	$T_J = 25^\circ\text{C}$ $T_J = 110^\circ\text{C}$	$I_{DRM}$ $I_{RRM}$	– –	– –	10 2.0	$\mu\text{A}$ mA
---	---	------------------------	--------	--------	-----------	---------------------

#### ON CHARACTERISTICS

*Peak On-State Voltage ( $I_{TM} = \pm 17 \text{ A Peak}; \text{Pulse Width} = 1 \text{ to } 2 \text{ ms}, \text{Duty Cycle} \leq 2\%$ )		$V_{TM}$	–	1.3	1.75	V
Gate Trigger Current (Continuous dc) ( $V_D = 12 \text{ Vdc}, R_L = 100 \Omega$ )		$I_{GT}$				mA
Quadrant I: MT2(+), G(+) All			–	6.0	50	
Quadrant II: MT2(+), G(–) 2N6348A and 2N6349A only			–	6.0	75	
Quadrant III: MT2(–), G(–) All			–	10	50	
Quadrant IV: MT2(–), G(+) 2N6348A and 2N6349A only			–	25	75	
*MT2(+), G(+); MT2(–), G(–) $T_C = -40^\circ\text{C}$			–	–	100	
*MT2(+), G(–); MT2(–), G(+) $T_C = -40^\circ\text{C}$			–	–	125	
Gate Trigger Voltage (Continuous dc) ( $V_D = 12 \text{ Vdc}, R_L = 100 \Omega$ )		$V_{GT}$				V
Quadrant I: MT2(+), G(+) All			–	0.9	2.0	
Quadrant II: MT2(+), G(–) 2N6348A and 2N6349A only			–	0.9	2.5	
Quadrant III: MT2(–), G(–) All			–	1.1	2.0	
Quadrant IV: MT2(–), G(+) 2N6348A and 2N6349A only			–	1.4	2.5	
*MT2(+), G(+); MT2(–), G(–) $T_C = -40^\circ\text{C}$			–	–	2.5	
*MT2(+), G(–); MT2(–), G(+) $T_C = -40^\circ\text{C}$			–	–	3.0	
Gate Non-Trigger Voltage ( $V_D = \text{Rated } V_{DRM}, R_L = 10 \text{ k } \Omega, T_J = 110^\circ\text{C}$ ) *MT2(+), G(+); MT2(–), G(–); MT2(+), G(–); MT2(–), G(+)		$V_{GD}$	0.2	–	–	V
Holding Current ( $V_D = 12 \text{ Vdc}, \text{Gate Open}$ ) Initiating Current = $\pm 200 \text{ mA}$	$T_C = 25^\circ\text{C}$ $*T_C = -40^\circ\text{C}$	$I_H$	–	6.0	40	mA
*Turn-On Time ( $V_D = \text{Rated } V_{DRM}, I_{TM} = 17 \text{ A}, I_{GT} = 120 \text{ mA}$ , Rise Time = $0.1 \mu\text{s}$ , Pulse Width = $2 \mu\text{s}$ )		$t_{gt}$	–	1.5	2.0	$\mu\text{s}$

#### DYNAMIC CHARACTERISTICS

Critical Rate of Rise of Commutation Voltage ( $V_D = \text{Rated } V_{DRM}, I_{TM} = 17 \text{ A}, \text{Commutating } di/dt = 6.1 \text{ A/ms}$ , Gate Unenergized, $T_C = 80^\circ\text{C}$ )		$dv/dt(c)$	–	5.0	–	$\text{V}/\mu\text{s}$
--	--	------------	---	-----	---	------------------------

\*Indicates JEDEC Registered Data.

# 2N6344A, 2N6348A, 2N6349A

## Voltage Current Characteristic of Triacs (Bidirectional Device)

Symbol	Parameter
$V_{DRM}$	Peak Repetitive Forward Off State Voltage
$I_{DRM}$	Peak Forward Blocking Current
$V_{RRM}$	Peak Repetitive Reverse Off State Voltage
$I_{RRM}$	Peak Reverse Blocking Current
$V_{TM}$	Maximum On State Voltage
$I_H$	Holding Current

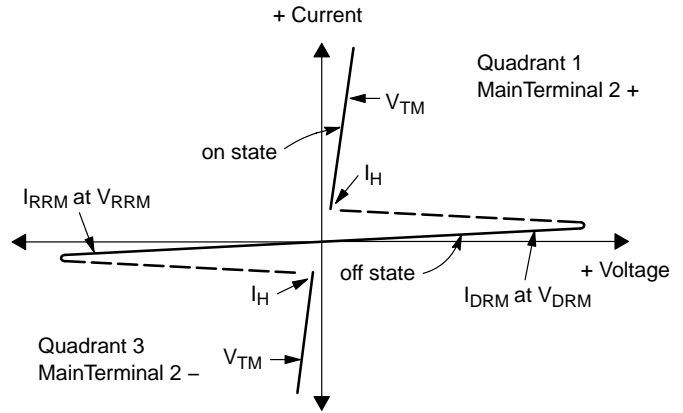

### Quadrant Definitions for a Triac

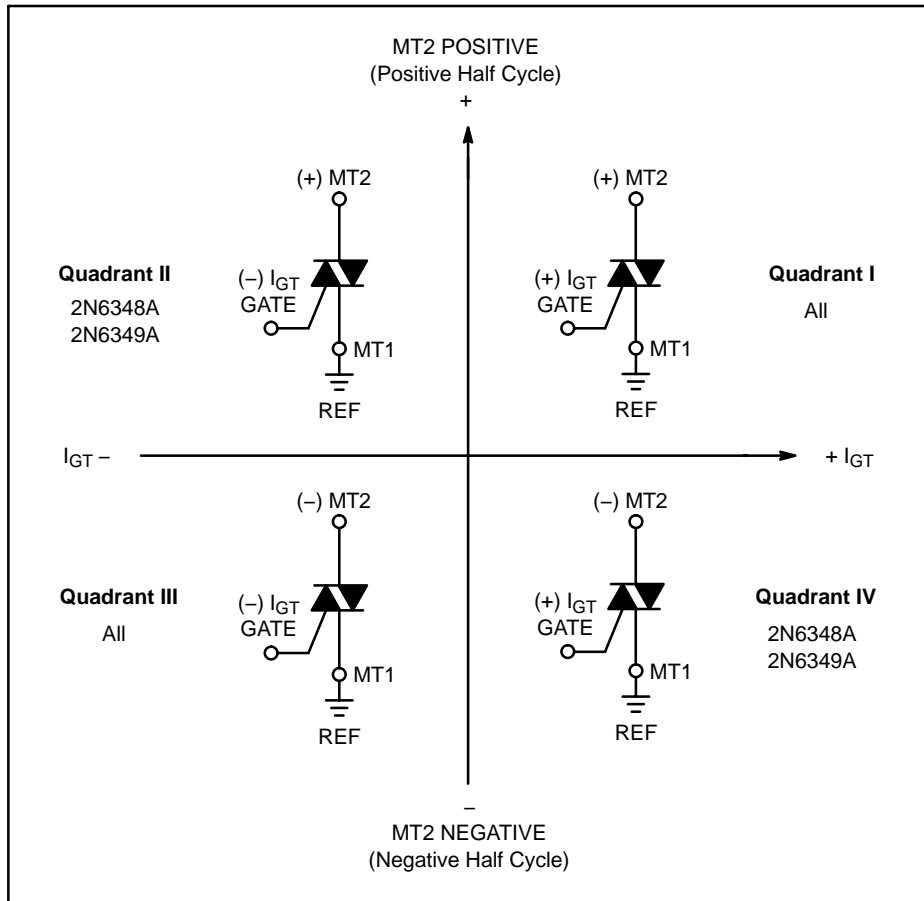

All polarities are referenced to MT1.  
With in-phase signals (using standard AC lines) quadrants I and III are used.

2N6344A, 2N6348A, 2N6349A

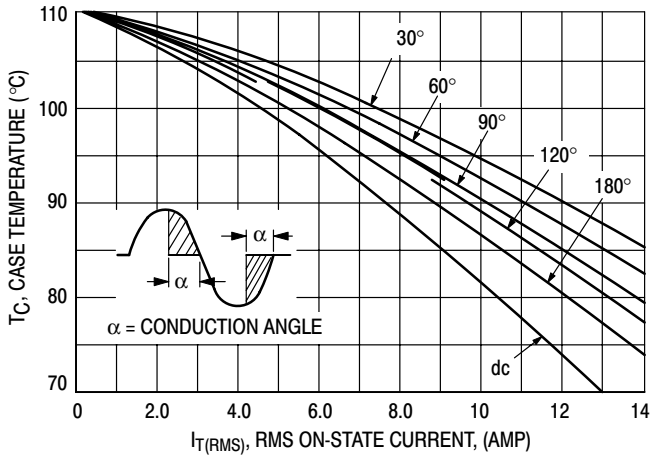

Figure 1. RMS Current Derating

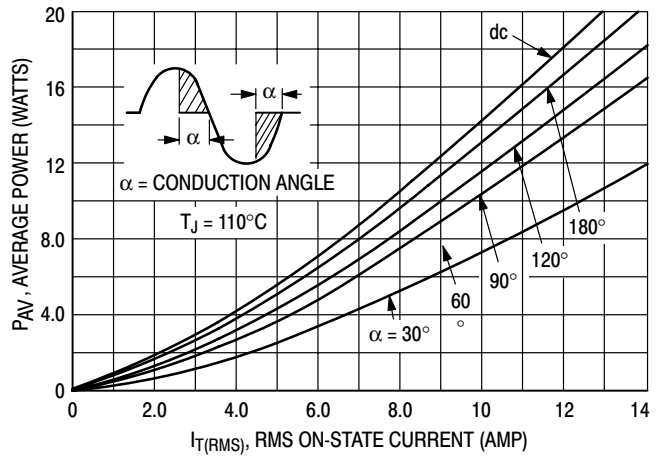

Figure 2. On-State Power Dissipation

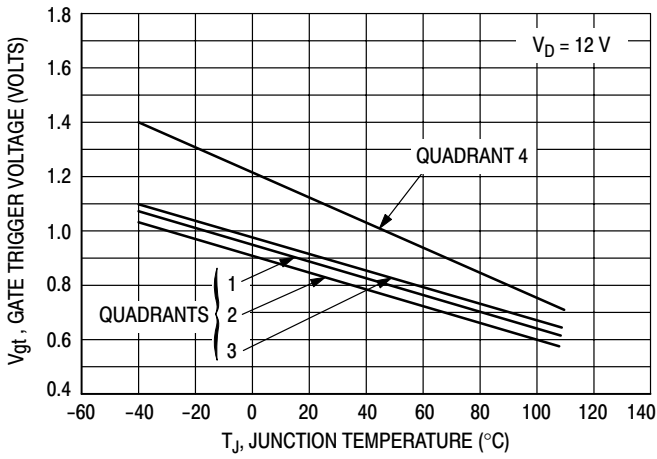

Figure 3. Typical Gate Trigger Voltage

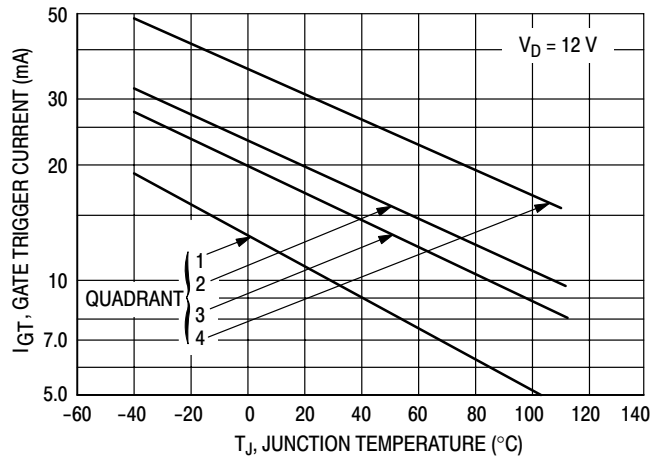

Figure 4. Typical Gate Trigger Current

2N6344A, 2N6348A, 2N6349A

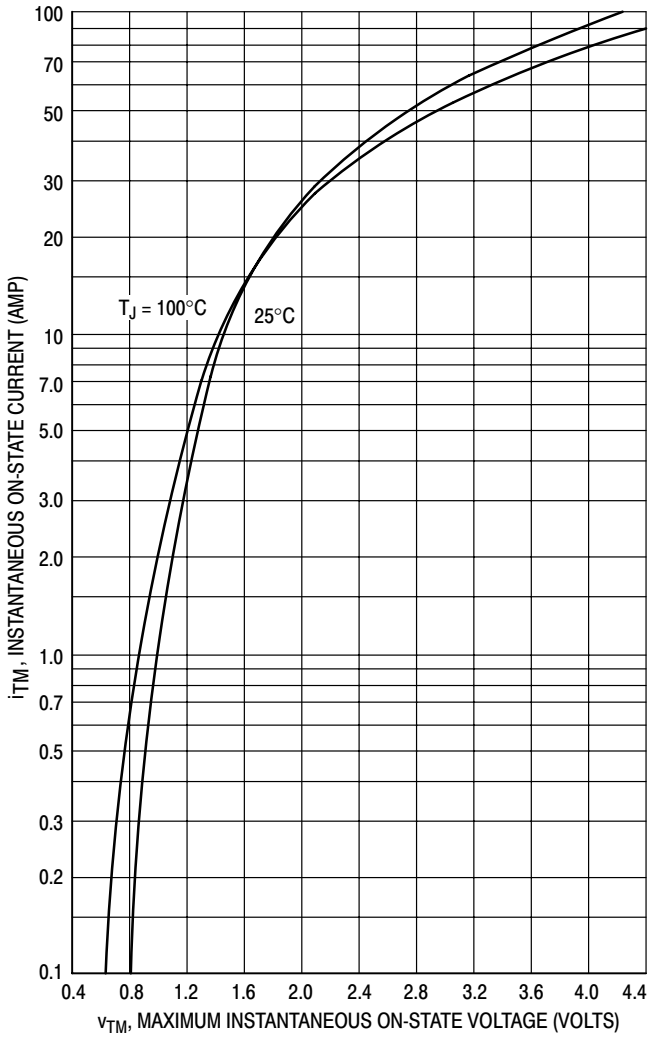

Figure 5. On-State Characteristics

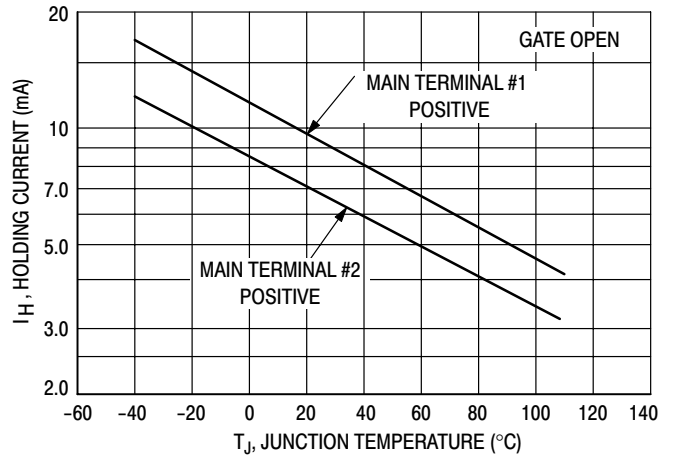

Figure 6. Typical Holding Current

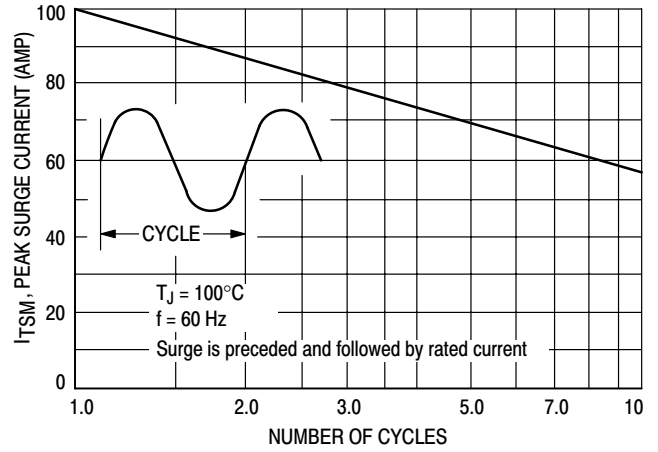

Figure 7. Maximum Non-Repetitive Surge Current

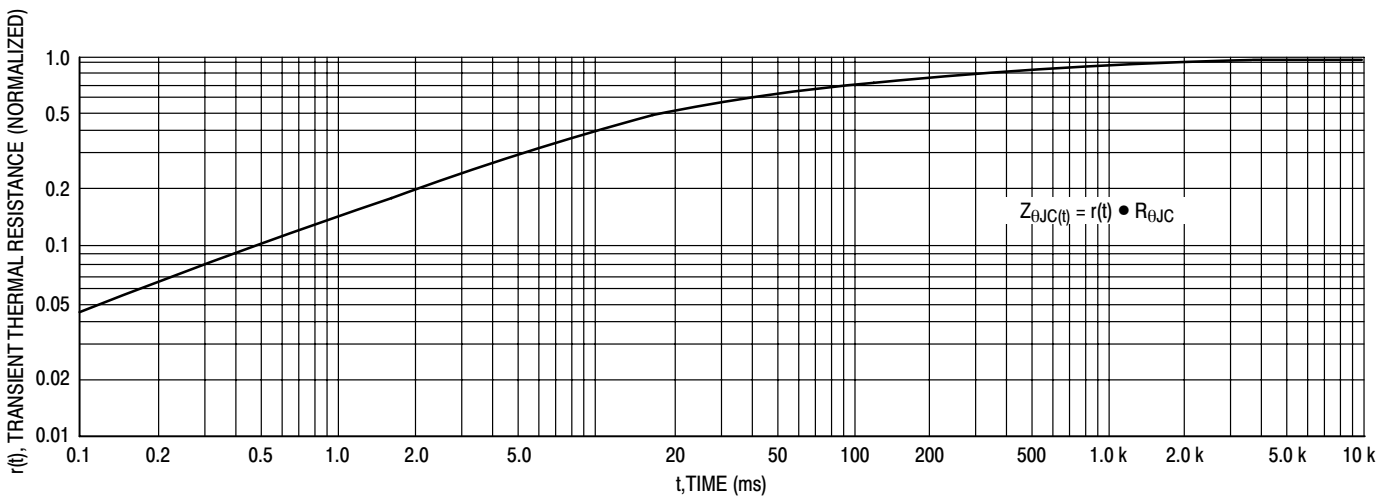
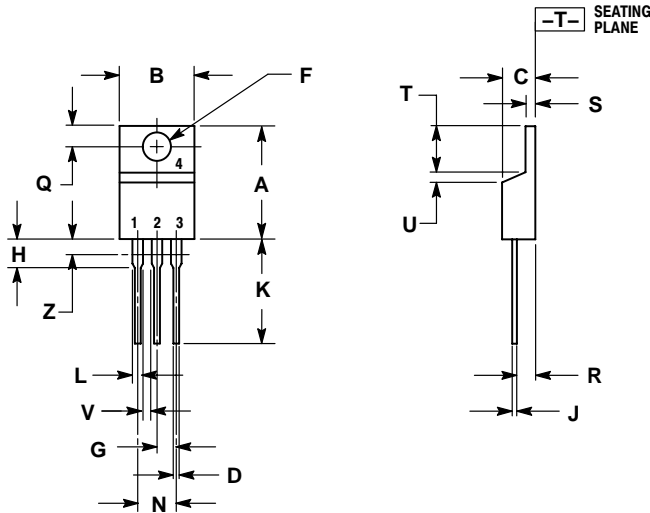

Figure 8. Typical Thermal Response

# 2N6344A, 2N6348A, 2N6349A

## PACKAGE DIMENSIONS

TO-220AB  
CASE 221A-07  
ISSUE AA



NOTES:

1. DIMENSIONING AND TOLERANCING PER ANSI Y14.5M, 1982.
2. CONTROLLING DIMENSION: INCH.
3. DIMENSION Z DEFINES A ZONE WHERE ALL BODY AND LEAD IRREGULARITIES ARE ALLOWED.

DIM	INCHES		MILLIMETERS	
	MIN	MAX	MIN	MAX
A	0.570	0.620	14.48	15.75
B	0.380	0.405	9.66	10.28
C	0.160	0.190	4.07	4.82
D	0.025	0.035	0.64	0.88
F	0.142	0.147	3.61	3.73
G	0.095	0.105	2.42	2.66
H	0.110	0.155	2.80	3.93
J	0.014	0.022	0.36	0.55
K	0.500	0.562	12.70	14.27
L	0.045	0.060	1.15	1.52
N	0.190	0.210	4.83	5.33
Q	0.100	0.120	2.54	3.04
R	0.080	0.110	2.04	2.79
S	0.045	0.055	1.15	1.39
T	0.235	0.255	5.97	6.47
U	0.000	0.050	0.00	1.27
V	0.045	---	1.15	---
Z	---	0.080	---	2.04

STYLE 4:

- PIN 1. MAIN TERMINAL 1
- PIN 2. MAIN TERMINAL 2
- PIN 3. GATE
- PIN 4. MAIN TERMINAL 2

ON Semiconductor and are registered trademarks of Semiconductor Components Industries, LLC (SCILLC). SCILLC reserves the right to make changes without further notice to any products herein. SCILLC makes no warranty, representation or guarantee regarding the suitability of its products for any particular purpose, nor does SCILLC assume any liability arising out of the application or use of any product or circuit, and specifically disclaims any and all liability, including without limitation special, consequential or incidental damages. "Typical" parameters which may be provided in SCILLC data sheets and/or specifications can and do vary in different applications and actual performance may vary over time. All operating parameters, including "Typicals" must be validated for each customer application by customer's technical experts. SCILLC does not convey any license under its patent rights nor the rights of others. SCILLC products are not designed, intended, or authorized for use as components in systems intended for surgical implant into the body, or other applications intended to support or sustain life, or for any other application in which the failure of the SCILLC product could create a situation where personal injury or death may occur. Should Buyer purchase or use SCILLC products for any such unintended or unauthorized application, Buyer shall indemnify and hold SCILLC and its officers, employees, subsidiaries, affiliates, and distributors harmless against all claims, costs, damages, and expenses, and reasonable attorney fees arising out of, directly or indirectly, any claim of personal injury or death associated with such unintended or unauthorized use, even if such claim alleges that SCILLC was negligent regarding the design or manufacture of the part. SCILLC is an Equal Opportunity/Affirmative Action Employer. This literature is subject to all applicable copyright laws and is not for resale in any manner.

### PUBLICATION ORDERING INFORMATION

LITERATURE FULFILLMENT:

Literature Distribution Center for ON Semiconductor  
P.O. Box 5163, Denver, Colorado 80217 USA  
Phone: 303-675-2175 or 800-344-3860 Toll Free USA/Canada  
Fax: 303-675-2176 or 800-344-3867 Toll Free USA/Canada  
Email: orderlit@onsemi.com

N. American Technical Support: 800-282-9855 Toll Free  
USA/Canada  
Europe, Middle East and Africa Technical Support:  
Phone: 421 33 790 2910  
Japan Customer Focus Center  
Phone: 81-3-5773-3850

ON Semiconductor Website: [www.onsemi.com](http://www.onsemi.com)

Order Literature: <http://www.onsemi.com/orderlit>

For additional information, please contact your local Sales Representative