

FEATURES

- Available as "HR" (high reliability) screened per MIL-PRF-19500, JANTX level. Add "HR" suffix to base part number.
- Available as non-RoHS (Sn/Pb plating), standard, and as RoHS by adding "-PBF" suffix.

MAXIMUM RATINGS

Rating	Symbol	Value	Unit
Peak repetitive off state voltage ⁽¹⁾ (Gate open, sine wave 50 to 60 Hz, T _J = 25° to 125°C)	2N6504	50	V
	2N6505	100	
	2N6507	400	
	2N6508	600	
	2N6509	800	
On-state current RMS (180° conduction angles; T _C = 85°C)	I _{T(RMS)}	25	A
Average on-state current (180° conduction angles; T _C = 85°C)	I _{T(AV)}	16	A
Peak non-repetitive surge current (1/2 cycle, sine wave 60 Hz, T _J = 100°C)	I _{TSM}	250	A
Forward peak gate power (pulse width ≤ 1.0 μs, T _C = 85°C)	P _{GM}	20	W
Forward average gate power (t = 8.3ms, T _C = 85°C)	P _{G(AV)}	0.5	W
Forward peak gate current (pulse width ≤ 1.0 μs, T _C = 85°C)	I _{GM}	2.0	A
Operating junction temperature range	T _J	-40 to +125	°C
Storage temperature range	T _{stg}	-40 to +150	°C

Maximum ratings are those values beyond which device damage can occur. Maximum ratings applied to the device are individual stress limit values (not normal operating conditions) and are not valid simultaneously. If these limits are exceeded, device functional operation is not implied, damage may occur and reliability may be affected.

- V_{DRM} and V_{RRM} for all types can be applied on a continuous basis. Ratings apply for zero or negative gate voltage; however, positive gate voltage shall not be applied concurrent with negative potential on the anode. Blocking voltages shall not be tested with a constant current source such that the voltage ratings of the devices are exceeded.

THERMAL CHARACTERISTICS

Characteristic	Symbol	Max	Unit
Thermal resistance, junction-to-case	R _{θJC}	1.5	°C/W
Maximum lead temperature for soldering purposes 1/8" in from case for 10 seconds	T _L	260	°C

ELECTRICAL CHARACTERISTICS (T_C = 25°C)

Characteristic	Symbol	Min	Typ	Max	Unit	
OFF CHARACTERISTICS						
Peak repetitive forward or reverse blocking current (V _{AK} = rated V _{DRM} or V _{RRM} , gate open)	I _{DRM} , I _{RRM}	T _J = 25°C	-	-	10	μA
		T _J = 125°C	-	-	2.0	mA
ON CHARACTERISTICS						
Forward on-state voltage ⁽²⁾ (I _{TM} = 50A)	V _{TM}	-	-	1.8	V	
Gate trigger current (continuous dc) (V _{AK} = 12Vdc, R _L = 100Ω)	I _{GT}	T _C = 25°C	-	9.0	30	mA
		T _C = -40°C	-	-	75	
Gate trigger voltage (continuous dc) (V _{AK} = 12 Vdc, R _L = 100Ω, T _C = -40°C)	V _{GT}	-	1.0	1.5	V	
Gate non-trigger voltage (V _{AK} = 12Vdc, R _L = 100Ω, T _J = 125°C)	V _{GD}	0.2	-	-	V	
Holding current (V _{AK} = 12Vdc, initiating current = 200mA, gate open)	I _H	T _C = 25°C	-	18	40	mA
		T _C = -40°C	-	-	80	
Turn-on time (I _{TM} = 25A, I _{GT} = 50mAdc)	t _{gt}	-	1.5	2.0	μs	

ELECTRICAL CHARACTERISTICS (T_C = 25°C)

Characteristic	Symbol	Min	Typ	Max	Unit
ON CHARACTERISTICS					
Turn-off time (V _{DRM} = rated voltage) (I _{TM} = 25A, I _R = 25A) (I _{TM} = 25A, I _R = 25A, T _J = 125°C)	t _q	-	15	-	μs
		-	35	-	
DYNAMIC CHARACTERISTICS					
Critical rate of rise of off state voltage (Gate open, rated V _{DRM} , exponential waveform)	dv/dt	-	50	-	V/μs

2. Pulse test: Pulse width ≤ 300μs, duty cycle ≤ 2%.

MECHANICAL CHARACTERISTICS

Case:	TO-220AB
Marking:	Body painted, alpha-numeric
Pin out:	See below

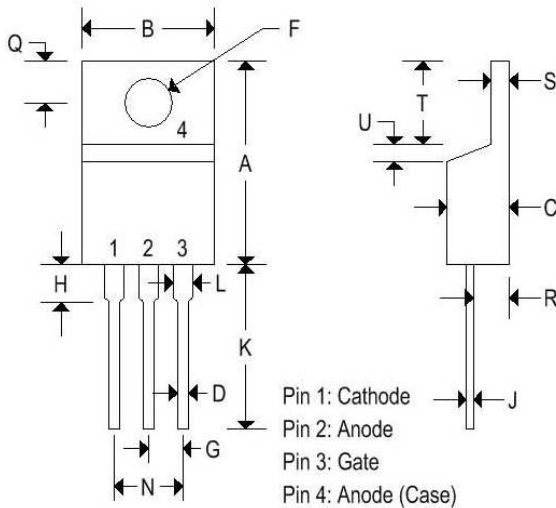

	TO-220AB			
	Inches		Millimeters	
	Min	Max	Min	Max
A	0.575	0.620	14.600	15.750
B	0.380	0.405	9.650	10.290
C	0.160	0.190	4.060	4.820
D	0.025	0.035	0.640	0.890
F	0.142	0.147	3.610	3.730
G	0.095	0.105	2.410	2.670
H	0.110	0.155	2.790	3.930
J	0.014	0.022	0.360	0.560
K	0.500	0.562	12.700	14.270
L	0.045	0.055	1.140	1.390
N	0.190	0.210	4.830	5.330
Q	0.100	0.120	2.540	3.040
R	0.080	0.110	2.040	2.790
S	0.045	0.055	1.140	1.390
T	0.235	0.255	5.970	6.480
U	-	0.050	-	1.270
V	0.045	-	1.140	-
Z	-	0.080	-	2.030

2N6504-2N6509

SILICON CONTROLLED RECTIFIERS

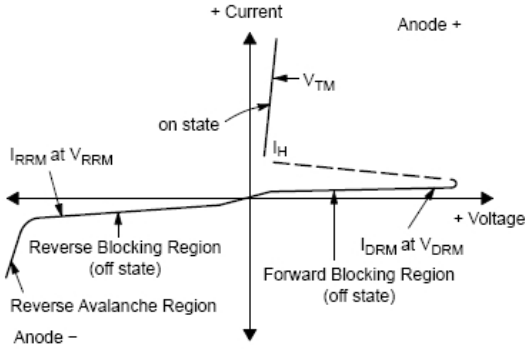

Symbol	Parameter
V_{DRM}	Peak repetitive off state forward voltage
I_{DRM}	Peak forward blocking current
V_{RRM}	Peak repetitive off state reverse voltage
I_{RRM}	Peak reverse blocking current
V_{TM}	Peak on state voltage
I_H	Holding current

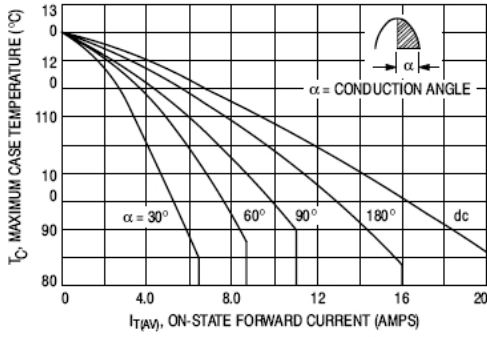

Average Current Derating

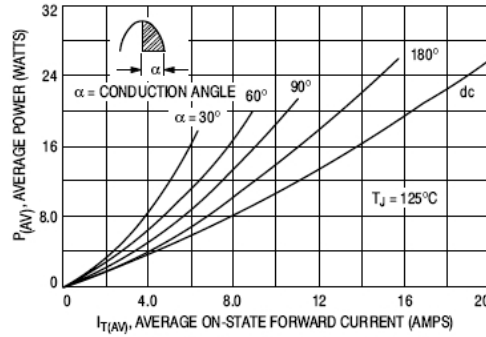

Maximum On-State Power Dissipation

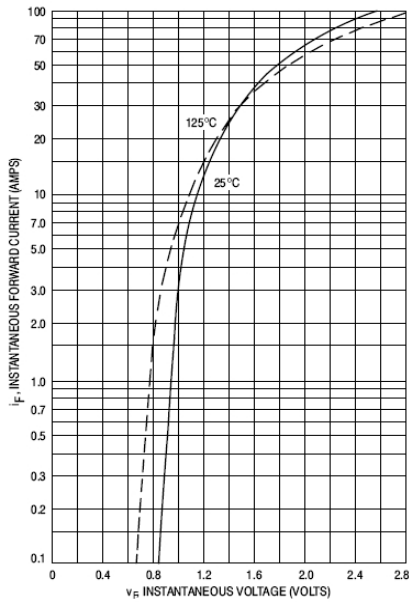

Typical On-State Characteristics

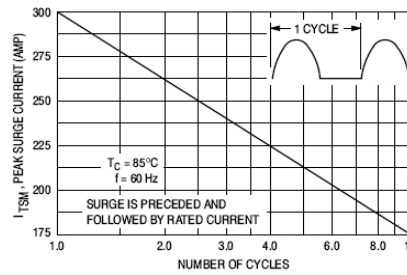

Maximum Non-Repetitive Surge Current

2N6504-2N6509

SILICON CONTROLLED RECTIFIERS

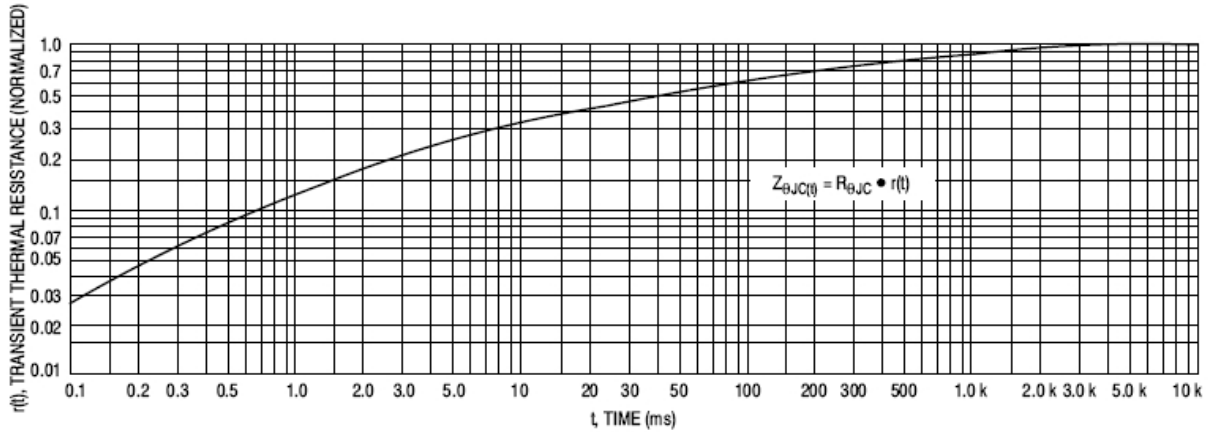

Thermal Response

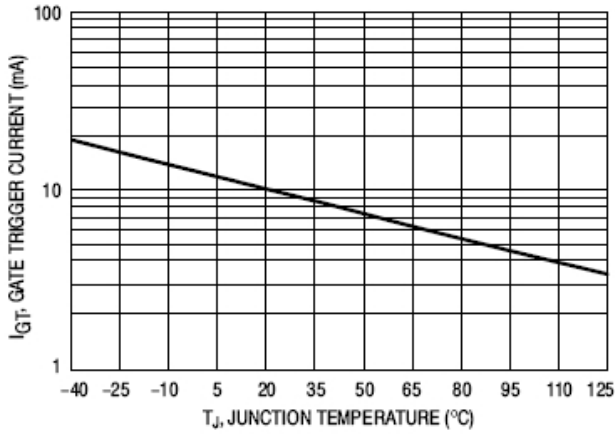

Typical Gate Trigger Current vs. Junction Temperature

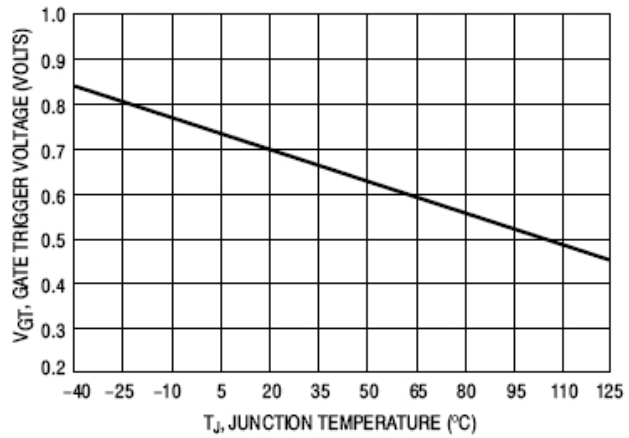

Typical Gate Trigger Voltage vs. Junction Temperature

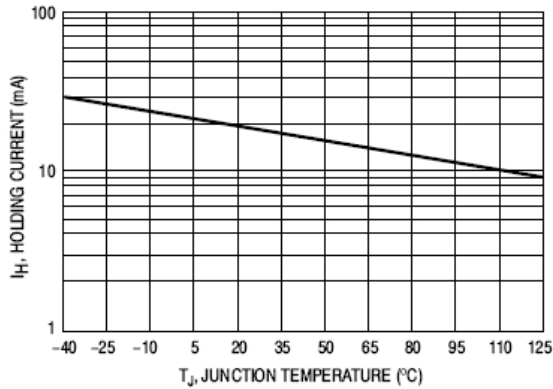

Typical Holding Current vs. Junction Temperature