

Silicon NPN Power Transistors

2N6531

DESCRIPTION

- With TO-220 package
- DARLINGTON
- High DC current gain

APPLICATIONS

- Power switching
- Hammer drivers
- Series and shunt regulators
- Audio amplifiers

PINNING

PIN	DESCRIPTION
1	Base
2	Collector;connected to mounting base
3	Emitter

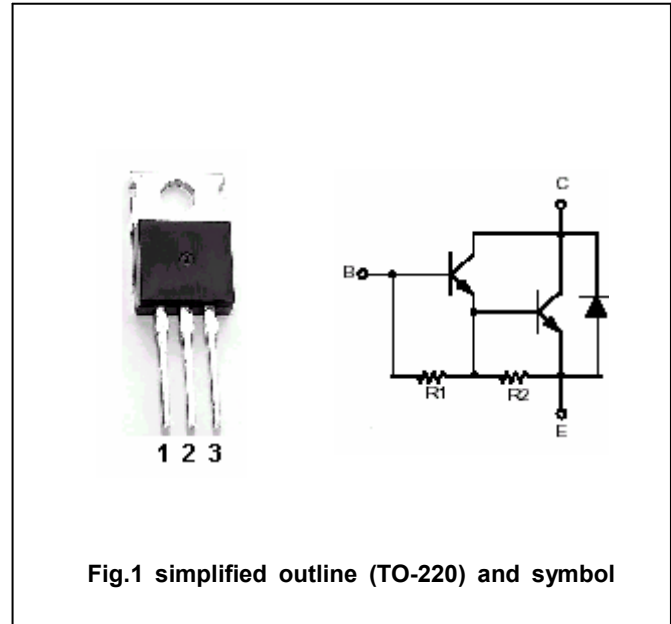
Absolute maximum ratings($T_a=25^\circ\text{C}$)

SYMBOL	PARAMETER	CONDITIONS	VALUE	UNIT
V_{CBO}	Collector-base voltage	Open emitter	100	V
V_{CEO}	Collector-emitter voltage	Open base	100	V
V_{EBO}	Emitter-base voltage	Open collector	5	V
I_C	Collector current		8	A
I_{CM}	Collector current-Peak		15	A
I_B	Base current		0.25	A
P_T	Total power dissipation	$T_C=25^\circ\text{C}$	65	W
T_j	Junction temperature		150	$^\circ\text{C}$
T_{stg}	Storage temperature		-65~150	$^\circ\text{C}$

THERMAL CHARACTERISTICS

SYMBOL	PARAMETER	VALUE	UNIT
$R_{\theta JC}$	Thermal resistance junction to case	1.92	$^\circ\text{C}/\text{W}$

Silicon NPN Power Transistors

2N6531

CHARACTERISTICS

T_j=25°C unless otherwise specified

SYMBOL	PARAMETER	CONDITIONS	MIN	TYP.	MAX	UNIT
V _{CEQ(SUS)}	Collector-emitter sustaining voltage	I _C =0.2A ; I _B =0	100			V
V _{CEsat-1}	Collector-emitter saturation voltage	I _C =3A ; I _B =6mA			2.0	V
V _{CEsat-2}	Collector-emitter saturation voltage	I _C =8A ; I _B =80mA			3.0	V
V _{BE-1}	Base -emitter on voltage	I _C =3A ; V _{CE} =3V			2.8	V
V _{BE-2}	Base -emitter on voltage	I _C =8A ; V _{CE} =3V			4.5	V
I _{CEV}	Collector cut-off current	V _{CE} =100V ; V _{BE} =-1.5V T _C =125°C			0.5 5.0	mA
I _{CEO}	Collector cut-off current	V _{CE} =100V ; I _B =0			1.0	mA
I _{EBO}	Emitter cut-off current	V _{EB} =5V ; I _C =0			5.0	mA
h _{FE-1}	DC current gain	I _C =3A ; V _{CE} =3V	500		10000	
h _{FE-2}	DC current gain	I _C =8A ; V _{CE} =3V	100		5000	
V _F	Diode forward voltage	I _F =5A			4.0	V

Silicon NPN Power Transistors

2N6531

PACKAGE OUTLINE

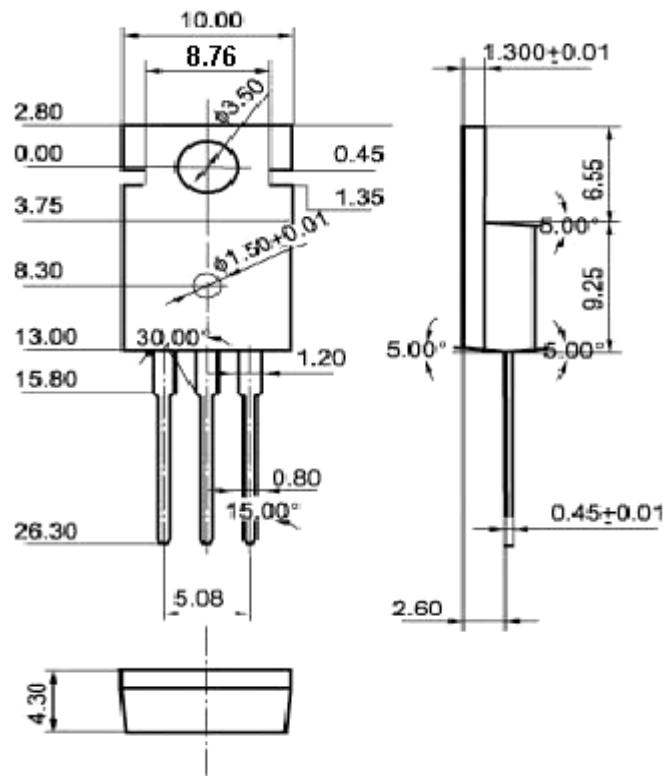

Fig.2 Outline dimensions(unindicated tolerance:±0.10 mm)