



MOTOROLA

SEMICONDUCTORS

P.O. BOX 20912 • PHOENIX, ARIZONA 85036

2N6659	MPF6659
2N6660	MPF6660
2N6661	MPF6661

N-CHANNEL ENHANCEMENT-MODE TMOS POWER FIELD-EFFECT TRANSISTOR

These TMOS Power FETs are designed for high-current, high-speed power switching applications such as switching power supplies, CMOS logic, microprocessor or TTL-to-high current interface and line drivers.

- Fast Switching Speed — $t_{on} = t_{off} = 5.0$ ns Max
- Low On-Resistance — 1.5 Ohm Typ — 2N6659/MPF6659
2.0 Ohm Typ — 2N6660/2N6661
— MPF6660/MPF6661
- Low Drive Requirement, $V_{GS(th)} = 2.0$ V Max
- Inherent Current Sharing Capability Permits Easy Paralleling of Many Devices

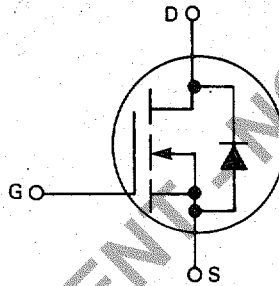

2.0 AMPERE

N-CHANNEL TMOS
POWER FET

35, 60, 90 VOLTS

2N6659
2N6660
2N6661

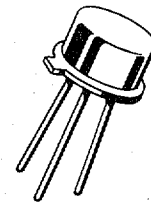

CASE 79-02
TO-205AD
(TO-39)

MAXIMUM RATINGS

Rating	Symbol	2N6659 MPF6659	2N6660 MPF6660	2N6661 MPF6661	Unit
Drain-Source Voltage	V_{DSS}	35	60	90	Vdc
Drain-Gate Voltage	V_{DGO}	35	60	90	Vdc
Gate-Source Voltage	V_{GS}	± 30			Vdc
Drain Current Continuous (1)	I_D	2.0			Adc
Pulsed (2)	I_{DM}	3.0			
		2N6659 2N6660 2N6661	MPF6659 MPF6660 MPF6661		
Total Power Dissipation @ $T_C = 25^\circ\text{C}$ Derate above 25°C	P_D	6.25 50	2.5 20		Watts mW/°C
Total Power Dissipation @ $T_A = 25^\circ\text{C}$ Derate above 25°C	P_D	— —	1.0 8.0		Watts mW/°C
Operating and Storage Temperature Range	T_J, T_{stg}	-55 to +150			°C

(1) The Power Dissipation of the package may result in a lower continuous drain current.
(2) Pulse Width $\leq 300 \mu\text{s}$ Duty Cycle $\leq 2.0\%$

MPF6659
MPF6660
MPF6661

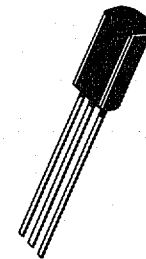

CASE 29-03
TO-226AE

ELECTRICAL CHARACTERISTICS ($T_A = 25^\circ\text{C}$ unless otherwise noted.)

Characteristics	Symbol	Min	Typ	Max	Unit
OFF CHARACTERISTICS					
Drain-Source Breakdown Voltage ($V_{GS} = 0, I_D = 10 \mu\text{A}$)	$V_{(BR)DSS}$	35 60 90	— — —	— — —	Vdc
Zero Gate Voltage Drain Current ($V_{DS} = \text{Maximum Rating}, V_{GS} = 0$)	I_{DSS}	—	—	10	μAdc
Gate-Body Leakage Current ($V_{GS} = 15 \text{ V}, V_{DS} = 0$)	I_{GSS}	—	—	100	nAdc
ON CHARACTERISTICS*					
Gate Threshold Voltage ($V_{DS} = V_{GS}, I_D = 1.0 \text{ mA}$)	$V_{GS(th)}$	0.8	1.4	2.0	Vdc
Drain-Source On-Voltage ($V_{GS} = 10 \text{ V}, I_D = 1.0 \text{ A}$)	$V_{DS(on)}$	— — —	— — —	1.8 3.0 4.0	Vdc
($V_{GS} = 5.0 \text{ V}, I_D = 0.3 \text{ A}$)		— — —	0.8 0.9 0.9	1.5 1.5 1.6	
Static Drain-Source On-Resistance ($V_{GS} = 10 \text{ Vdc}, I_D = 1.0 \text{ Adc}$)	$r_{DS(on)}$	— — —	— — —	1.8 3.0 4.0	Ohms
On-State Drain Current ($V_{DS} = 25 \text{ V}, V_{GS} = 10 \text{ V}$)	$I_{D(on)}$	1.0	2.0	—	Amps
Forward Transconductance ($V_{DS} = 25 \text{ V}, I_D = 0.5 \text{ A}$)	g_{fs}	170	—	—	mmhos
DYNAMIC CHARACTERISTICS					
Input Capacitance ($V_{DS} = 25 \text{ V}, V_{GS} = 0, f = 1.0 \text{ MHz}$)	C_{iss}	—	30	50	pF
Output Capacitance ($V_{DS} = 25 \text{ V}, V_{GS} = 0, f = 1.0 \text{ MHz}$)	C_{oss}	—	20	40	pF
Reverse Transfer Capacitance ($V_{DS} = 25 \text{ V}, V_{GS} = 0, f = 1.0 \text{ MHz}$)	C_{rss}	—	3.6	10	pF
SWITCHING CHARACTERISTICS*					
Turn-On Time (See Figure 1)	t_{on}	—	—	5.0	ns
Turn-Off Time (See Figure 1)	t_{off}	—	—	5.0	ns
Rise Time	t_r	—	—	5.0	ns
Fall Time	t_f	—	—	5.0	ns

*Pulse Test: Pulse Width $\leq 300 \mu\text{s}$, Duty Cycle $\leq 2\%$.

Motorola reserves the right to make changes to any products herein to improve reliability, function or design. Motorola does not assume any liability arising out of the application or use of any product or circuit described herein; neither does it convey any license under its patent rights nor the rights of others.



RESISTIVE SWITCHING

FIGURE 1 — SWITCHING TEST CIRCUIT

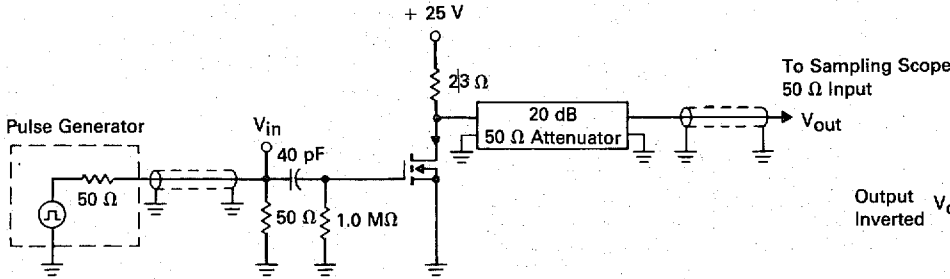

FIGURE 2 — SWITCHING WAVEFORMS

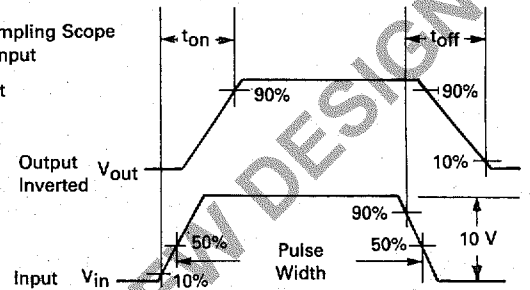

FIGURE 3 — $V_{GS(th)}$ NORMALIZED versus TEMPERATURE

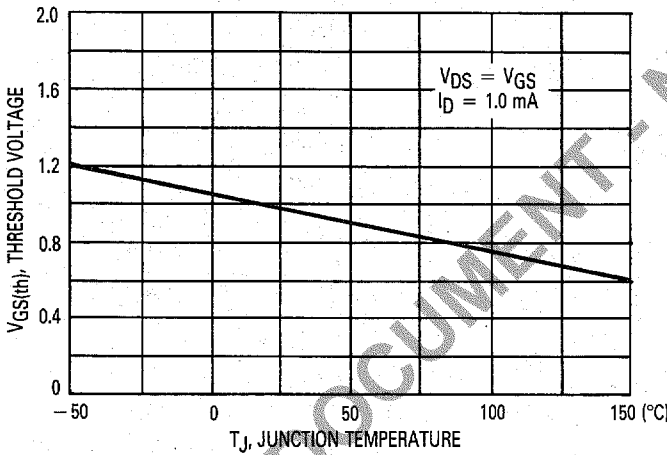

FIGURE 4 — ON-REGION CHARACTERISTICS

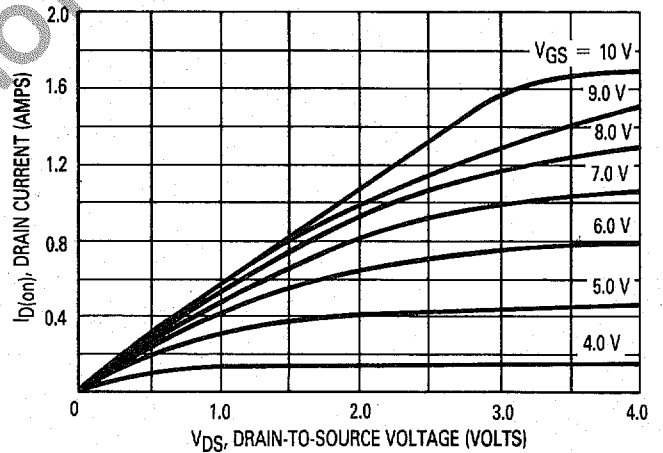

FIGURE 5 — OUTPUT CHARACTERISTICS

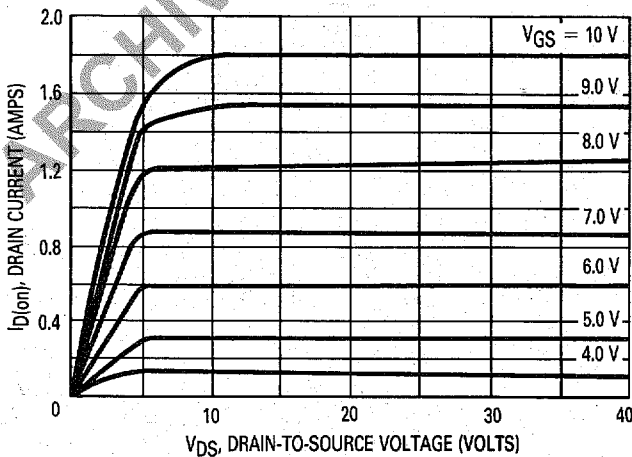

FIGURE 6 — CAPACITANCE versus DRAIN-TO-SOURCE VOLTAGE

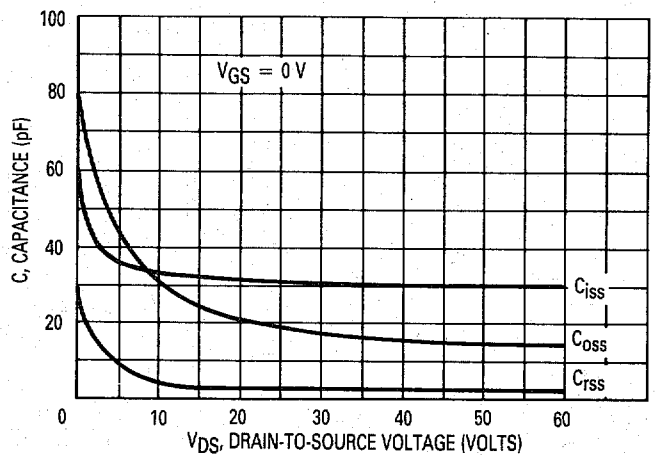
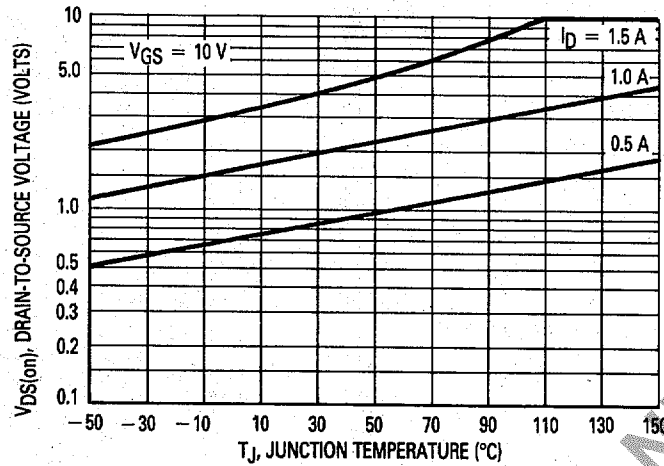
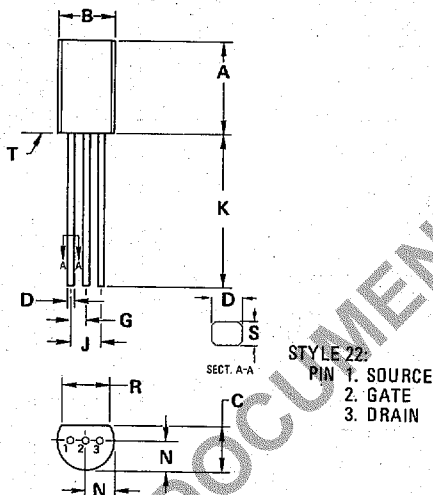

FIGURE 7 — ON-VOLTAGE versus TEMPERATURE



OUTLINE DIMENSIONS



STYLE 22:
PIN 1. SOURCE
2. GATE
3. DRAIN

NOTES:

1. DIMENSIONS -A- AND -B- ARE DATUMS.
2. -T- IS SEATING PLANE.
3. POSITIONAL TOLERANCE FOR LEADS:
 $\pm 0.10 (0.004) \text{ (M)} \text{ T } \text{A} \text{ (M)} \text{ B} \text{ (M)}$
4. DIMENSIONING AND TOLERANCING PER ANSI Y14.5, 1973.

DIM	MILLIMETERS		INCHES	
	MIN	MAX	MIN	MAX
A	7.37	7.87	0.290	0.310
B	4.44	5.21	0.175	0.205
C	3.18	4.19	0.125	0.165
D	0.46	0.61	0.018	0.024
G	1.27 BSC		0.050 BSC	
J	2.54 BSC		0.100 BSC	
K	12.70	—	0.500	—
N	2.03	2.92	0.080	0.115
R	3.43	—	0.135	—
S	0.46	0.61	0.018	0.024

CASE 29-03
TO-226AE

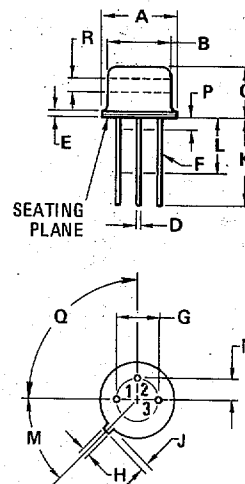

STYLE 6:
PIN 1. SOURCE
2. GATE
3. DRAIN/CASE

DIM	MILLIMETERS		INCHES	
	MIN	MAX	MIN	MAX
A	8.89	9.40	0.350	0.370
B	8.00	8.51	0.315	0.335
C	6.10	6.60	0.240	0.260
D	0.406	0.533	0.016	0.021
E	0.229	3.18	0.009	0.125
F	0.406	0.483	0.016	0.019
G	4.83	5.33	0.190	0.210
H	0.711	0.864	0.028	0.034
J	0.737	1.02	0.029	0.040
K	12.70	—	0.500	—
L	6.35	—	0.250	—
M	45° NOM		45° NOM	
P	—	1.27	—	0.050
Q	90° NOM		90° NOM	
R	2.54	—	0.100	—

All JEDEC dimensions and notes apply.

CASE 79-02
TO-205AD
(TO-39)



MOTOROLA Semiconductor Products Inc.

BOX 20912 • PHOENIX, ARIZONA 85036 • A SUBSIDIARY OF MOTOROLA INC.