

FEATURES

- Available as "HR" (high reliability) screened per MIL-PRF-19500, JANTX level. Add "HR" suffix to base part number.
- Available as non-RoHS (Sn/Pb plating), standard, and as RoHS by adding "-PBF" suffix.

MAXIMUM RATINGS

Rating	Symbol	2N681-2N692	2N5204-2N5207	Unit
RMS on-state current	$I_{T(RMS)}$	25	35	A
Average on-state current	$I_{T(AV)}$	16	22	A
@ T_C	T_C	-65 to +65	-40 to +40	°C
Peak one cycle surge @ 50 Hz	I_{TSM}	145	285	A
Peak one cycle surge @ 60 Hz		150	300	A
Fusing @ 50 Hz	i^2t	103	410	A ² s
Fusing @ 60 Hz		94	375	
Gate current to trigger	I_{GT}	40	40	mA
Typical critical dv/dt exponential to V_{DRM}	dv/dt	-	100	V/ μ s
Critical rate of rise	di/dt	75-100	100	A/ μ s
Typical junction temperature	T_J	-65 to 125	-40 to 125	°C

VOLTAGE RATINGS (Applied gate voltage zero or negative)

Part Number	V_{RRM}, V_{DRM} Maximum repetitive peak reverse and off-state voltage (V)	V_{RSM} Maximum non-repetitive peak reverse voltage $t_p \leq 5$ ms (V)
	$T_J = -65$ to $+125^\circ\text{C}$	$T_J = -65$ to $+125^\circ\text{C}$
2N681	25	35
2N682	50	75
2N683	100	150
2N685	200	300
2N687	300	400
2N688	400	500
2N689	500	600
2N690	600	720
2N691	700	840
2N692	800	960
	$T_J = -40$ to 125°C	$T_J = -40$ to 125°C
2N5204	600	720
2N5205	800	960
2N5206	1000	1200
2N5207	1200	1440

ELECTRICAL CHARACTERISTICS ($T_A = 25^\circ\text{C}$ unless otherwise specified)

Symbol	Characteristics	2N681-2N692	2N5204-2N5207	Units	Conditions	
$I_{T(RMS)}$	Maximum RMS on-state current	25	35	A		
$I_{T(AV)}$	Maximum average on-state current	16	22	A	180° half sine wave conduction	
	@ $T_C =$	-65 to +65	-40 to +40	$^\circ\text{C}$		
I_{TSM}	Maximum peak one cycle, non-repetitive surge current	145	285	A	50 Hz half cycle sine wave or 6 ms rectangular pulse	Following any rated load condition and with rated V_{RRM} applied following surge
		150	300		60 Hz half cycle sine wave or 5 ms rectangular pulse	
		170	340		50 Hz half cycle sine wave or 6 ms rectangular pulse	Same conditions as above except with V_{RRM} applied following surge = 0
		180	355		60 Hz half cycle sine wave or 5 ms rectangular pulse	
I^2t	Maximum I^2t capability, for fusing	103	410	A^2s	t = 10 ms	Rated V_{RRM} applied following surge, initial $T_J = 125^\circ\text{C}$
		94	375		t = 8.3 ms	
I^2t	Maximum I^2t capability for individual device fusing	145	580	A^2s	t = 10 ms	$V_{RRM} = 0$ following surge, initial $T_J = 125^\circ\text{C}$
		135	530		t = 8.3 ms	
I^2vt	Maximum I^2vt capability for individual device fusing ⁽¹⁾	1450	5800	A^2Vs	t = 0.1 to 10ms initial $T_J \leq 125^\circ\text{C}$, V_{RRM} following surge = 0	
V_{TM}	Maximum peak on-state voltage	2	2.3	V	$T_J = 25^\circ\text{C}$, $I_{T(AV)} = 16\text{A}(50\text{A peak}) - 2\text{N}681$ $I_{T(AV)} = 22\text{A}(70\text{A peak}) - 2\text{N}5204$	
I_H	Maximum holding current	20 @ 25°C	200 @ -40°C	mA	Anode supply = 24V, initial $I_T = 1.0\text{A}$	
BLOCKING						
dv/dt	Minimum critical rate of rise of off-state voltage	100 typical	100	$\text{V}/\mu\text{s}$	$T_J = 125^\circ\text{C}$ exponential to 100% rated V_{DRM}	
		250 typical	250		$T_J = 125^\circ\text{C}$ exponential to 67% rated V_{DRM}	

Symbol	Characteristics	2N681-2N692	2N5204-2N5207	Units	Conditions	
$I_R^{(-)}$ & $I_D^{(-)}$	Maximum reverse and off-state current	$I_{R(AV)}$ & $I_{D(AV)}$ (average values)	I_{RM} & I_{DM} (peak values)	mA	$T_J = 125^\circ\text{C}$, gate open circuited	
	V_{RRM} & $V_{DRM} =$	-	-			
	25 to 150V	6.5	-			
	200 & 250V	6.0	-			
	300V	5.0	-			
	400V	4.0	-			
	500V	3.0	-			
	600V	2.5	3.3			
	700V	2.25	-			
	800V	2.0	2.5			
1000V	-	2.0				
1200V	-	1.7				
SWITCHING						
t_d	Typical delay time	1	1	μs	$T_C = 25^\circ\text{C}$, $V_{DM} = \text{rated } V_{DRM}$, $I_{TM} = 10\text{A}$ dc resistive circuit. Gate pulse: 10 V, 40 Ω source, $t_p = 6\mu\text{s}$, $t_r = 0.1\mu\text{s}$	
di/dt	Maximum non-repetitive rate of rise of turned-on current $V_{DM} = 25$ to 600 V	100	-	A/ μs	$T_C = 125^\circ\text{C}$, $V_{DM} = \text{rated } V_{DRM}$, $I_{TM} = 2 \times$ di/dt, gate pulse: 20V, 15 Ω , $t_p = 6\mu\text{s}$, $t_r = 0.1 \mu\text{s}$ maximum	
	$V_{DM} = 700$ to 800 V	75	-			
		-	100		$T_C = 125^\circ\text{C}$, $V_{DM} = 600\text{V}$, $I_{TM} = 200\text{A}$ @ 400Hz max. Gate pulse: 20V, 15 Ω , $t_p = 6\mu\text{s}$, $t_r = 0.1\mu\text{s}$ max.	
TRIGGERING						
P_{GM}	Maximum peak gate power	5	60	W	$t_p \leq 5\text{ms} - 2\text{N681}$ $t_p \leq 500\mu\text{s} - 2\text{N5204}$	
$P_{G(AV)}$	Maximum average gate power	0.5	0.5	W		
I_{GM}	Maximum peak positive gate current	2	2	A		
$+V_{GM}$	Maximum peak positive gate voltage	10	-	V		
$-V_{GM}$	Maximum peak negative gate voltage	5	5	V		
I_{GT}	Maximum required DC gate current to trigger	80	80	mA	$T_C = \text{min rated value}$. Max. required gate trigger current is the lowest value which will trigger all units with 6V anode to cathode	
		40	40			$T_C = 25^\circ\text{C}$
		18.5	20			$T_C = 125^\circ\text{C}$
	Typical DC gate current to trigger	30	30	$T_C = 25^\circ\text{C}$, 6V anode to cathode		

2N681-2N692, 2N5204-2N5207

SILICON CONTROLLED RECTIFIER

Symbol	Characteristics	2N681-2N692	2N5204-2N5207	Units	Conditions
V_{GT}	Maximum required DC gate voltage to trigger	3	3	V	$T_C = -65^\circ\text{C}$. Max. required gate trigger voltage is the lowest value which will trigger all units with 6V anode to cathode
		2	2		$T_C = 25^\circ\text{C}$
	Typical DC gate voltage to trigger	1.5	1.5		$T_C = 25^\circ\text{C}$ 6V anode to cathode
V_{GD}	Maximum DC gate voltage not to trigger	0.25	0.25	V	$T_C = 125^\circ\text{C}$. Max. gate voltage not to trigger is the maximum value which will not trigger any unit with rated V_{DRM} anode to cathode

Note 1: I^2t for time $t_x \approx I^2\sqrt{t} \bullet \sqrt{t_x}$

THERMAL –MECHANICAL CHARACTERISTICS

Symbol	Characteristics	2N681-2N692	2N5204-2N5207	Units	Conditions
T_J	Operating junction temperature range	-65 to 125	-40 to 125	$^\circ\text{C}$	
T_{stg}	Storage temperature range	-65 to 125	-40 to 125	$^\circ\text{C}$	
R_{thJC}	Maximum internal thermal resistance, junction to case	1.5	1.5	$^\circ\text{C}/\text{W}$	DC operation
R_{thCS}	Thermal resistance, case to sink	0.35	0.35	$^\circ\text{C}/\text{W}$	Mounting surface smooth, flat and greased

MECHANICAL CHARACTERISTICS

Case	TO-48
Marking	Alpha-numeric
Pin out	See below

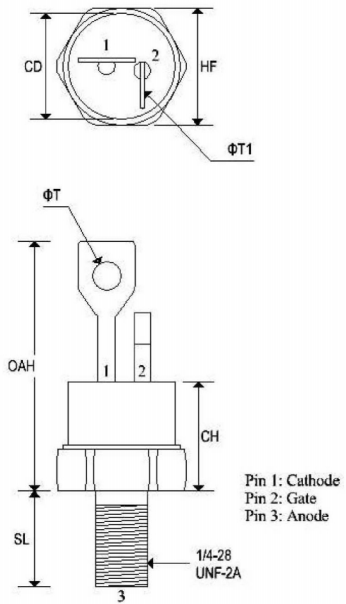

	TO-48			
	Inches		Millimeters	
	Min	Max	Min	Max
CD	-	0.543	-	13.793
CH	-	0.550	-	13.970
HF	0.544	0.563	13.817	14.301
OAH	-	1.193	-	30.303
SL	0.422	0.453	10.718	11.507
ΦT	0.125	0.165	3.175	4.191
ΦT_1	0.060	0.075	1.524	1.905

Note: Contour and angular orientation of terminals 1 and 2 with respect to hex portion and to each other are optional.

2N681 Series

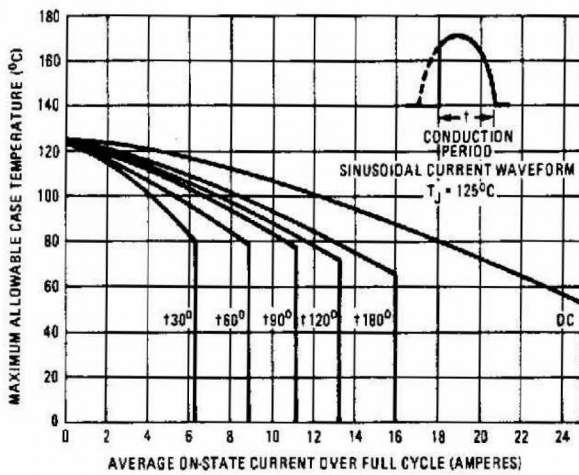

Fig. 1 – Maximum Allowable Case Temperature Vs. Average On-State Current, 2N681 Series

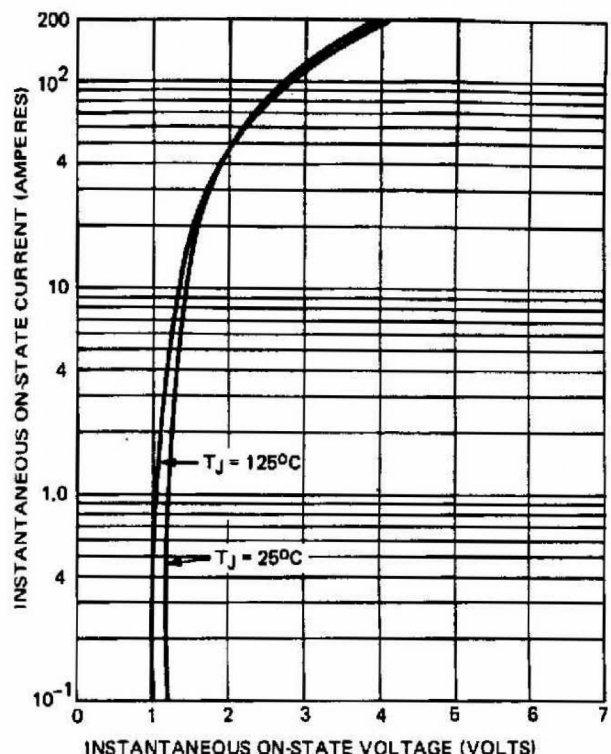

Fig. 2 – Maximum On-State Voltage Vs. Current, 2N681 Series

2N681 Series

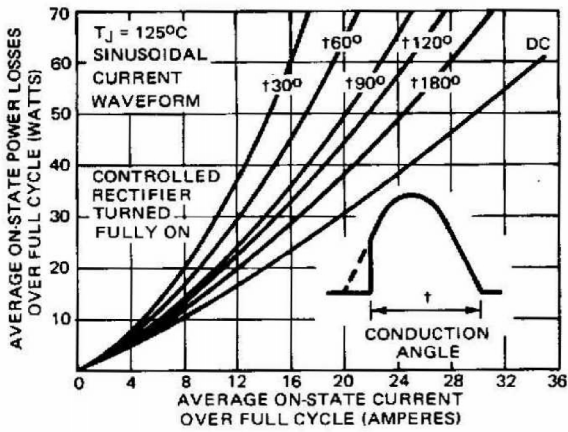

Fig. 3 – Maximum Low Level On-State Power Loss Vs. Current (Sinusoidal Current Waveform), 2N681 Series

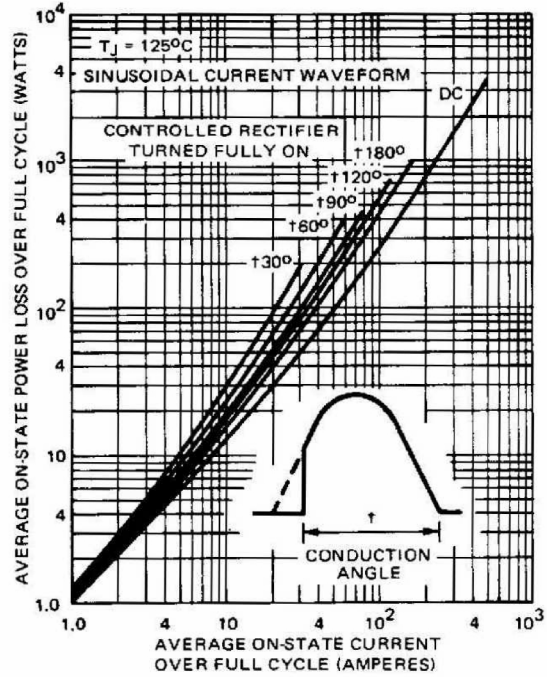

Fig. 4 – Maximum High Level On-State Power Loss Vs. Current (Sinusoidal Current Waveform), 2N681 Series

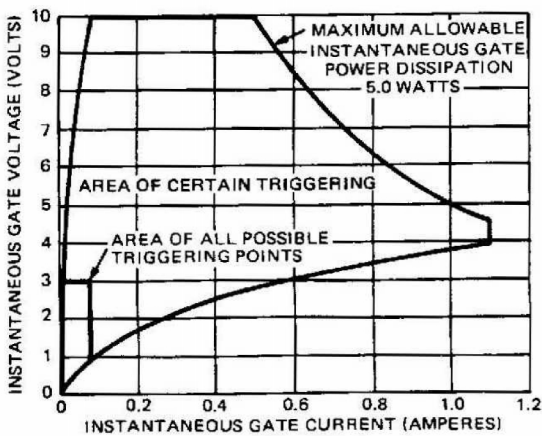

Fig. 5 – Gate Characteristics, 2N681 Series

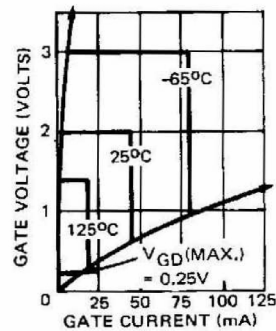

Fig. 5A – Area of All Possible Triggering Points Vs. Temperature 2N681 Series

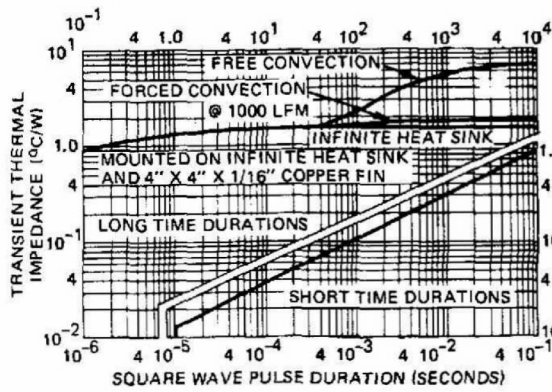

Fig. 6 – Maximum Transient Thermal Impedance, Junction to Case, Vs. Pulse Duration, 2N681 Series

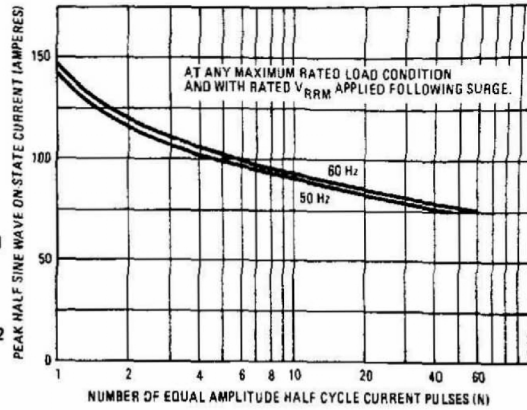

Fig. 7 – Maximum Non-Repetitive Surge Current, Vs. Number of Current Pulses, 2N681 Series

2N5204 Series

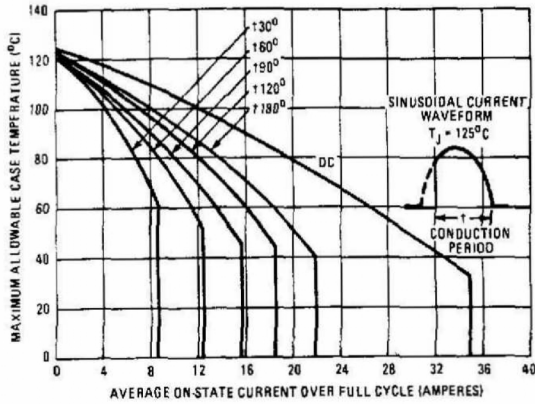

Fig. 8 – Maximum Allowable Case Temperature Vs. Average On-State Current (Sinusoidal Current Waveform), 2N5204 Series

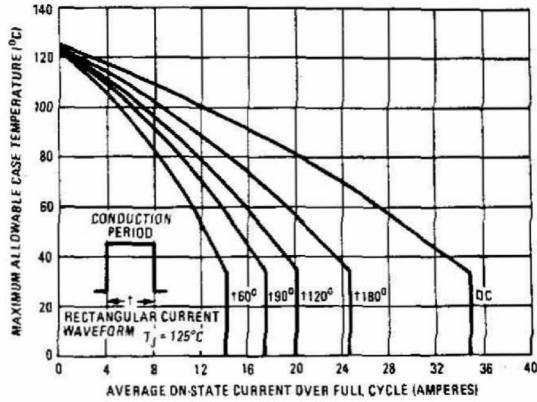

Fig. 9 – Maximum Allowable Case Temperature Vs. Average On-State Current (Rectangular Current Waveform), 2N5204 Series

2N5204 Series

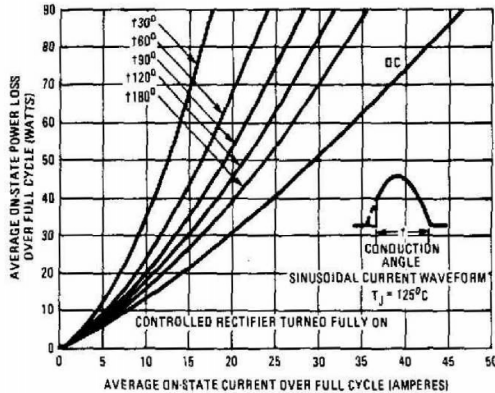

Fig. 10 – Maximum Low-Level On-State Power Loss Vs. Average On-State Current (Sinusoidal Current Waveform), 2N5204 Series

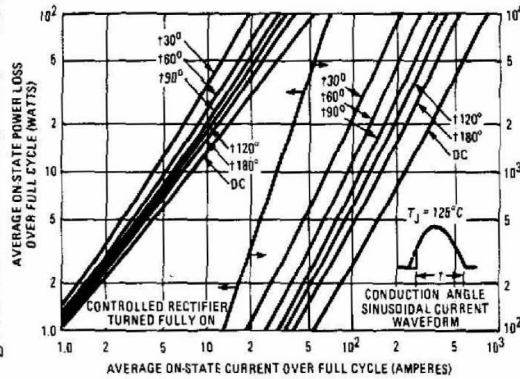

Fig. 11 – Maximum High-Level On-State Power Loss Vs. Average On-State Current (Sinusoidal Current Waveform), 2N5204 Series

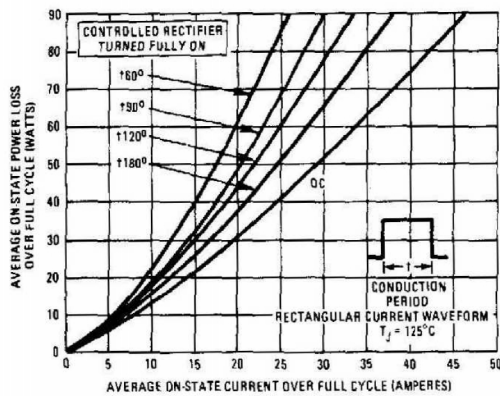

Fig. 12 – Maximum Low-Level On-State Power Loss Vs. Average On-State Current (Rectangular Current Waveform), 2N5204 Series

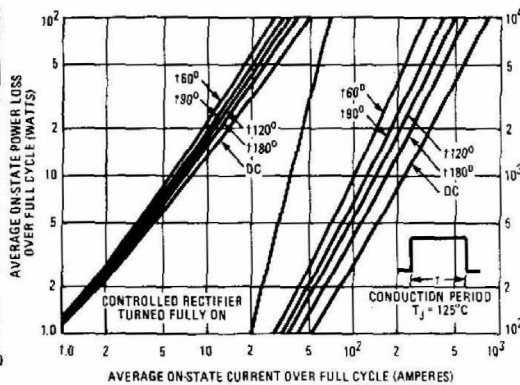

Fig. 13 – Maximum High-Level On-State Power Loss Vs. Average On-State Current (Rectangular Current Waveform), 2N5204 Series

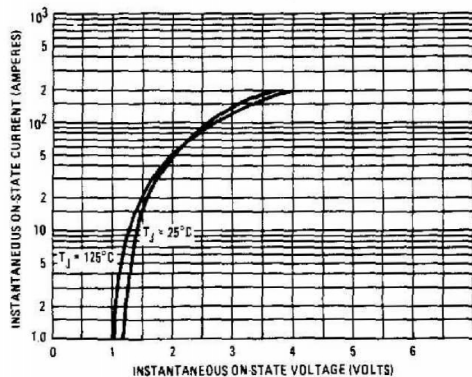

Fig. 14 – Maximum Instantaneous On-State Voltage Vs. Instantaneous On-State Current, 2N5204 Series

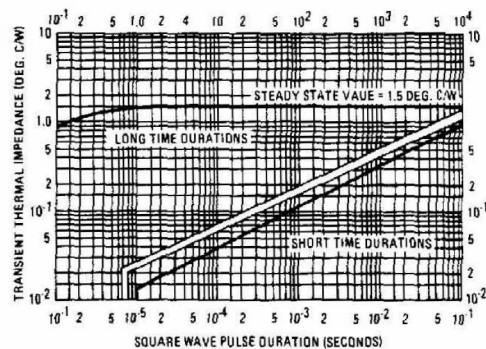

Fig. 15 – Maximum Transient Thermal Resistance, Junction to Case, Vs. Pulse Duration, 2N5204 Series