



2N7000

Power MOSFET

N-CHANNEL ENHANCEMENT MODE

DESCRIPTION

The UTC **2N7000** has been designed to minimize on-state resistance while provide rugged, reliable, and fast switching performance. It can be used in most applications requiring up to 400mA DC and can deliver pulsed currents up to 2A. The product is particularly suited for low voltage, low current applications such as small servo motor control, power MOSFET gate drivers, and other switching applications

FEATURES

- *High density cell design for low $R_{DS(ON)}$
- *Voltage controlled small signal switch
- *Rugged and reliable
- *High saturation current capability

SYMBOL

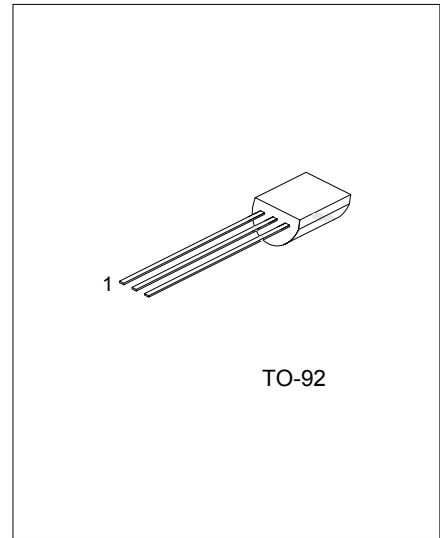
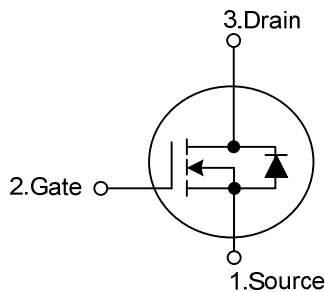

ORDERING INFORMATION

Ordering Number		Package	Pin Assignment			Packing
Lead Free	Halogen Free		1	2	3	
2N7000L-T92-B	2N7000G-T92-B	TO-92	S	G	D	Tape Box
2N7000L-T92-K	2N7000G-T92-K	TO-92	S	G	D	Bulk
2N7000L-T92-R	2N7000G-T92-R	TO-92	S	G	D	Tape Reel

Note: Pin Assignment: G: Gate D: Drain S: Source

<p>2N7000L-T92-B</p> <p>(1)Packing Type (2)Package Type (3)Lead Free</p>	<p>(1) B: Tape Box, K: Bulk, R: Tape Reel (2) T92: TO-92 (3) G: Halogen Free, L: Lead Free</p>
--	--

■ ABSOLUTE MAXIMUM RATINGS (Ta=25°C)

PARAMETER	SYMBOL	RATINGS	UNIT
Drain-Source Voltage	V _{DSS}	60	V
Drain-Gate Voltage (R _{GS} ≤1MΩ)	V _{DGR}	60	V
Gate -Source Voltage	V _{GS}	±20	V
		±40	V
Maximum Drain Current	I _D	115	mA
		800	mA
Maximum Power Dissipation Derated above 25°C	P _D	400 3.2	mW mW/°C
Operating and Storage Temperature	T _J ,T _{STG}	-55 ~ +150	°C

Note: Absolute maximum ratings are those values beyond which the device could be permanently damaged.

Absolute maximum ratings are stress ratings only and functional device operation is not implied.

■ THERMAL DATA

PARAMETER	SYMBOL	RATINGS	UNIT
Junction to Ambient	θ _{JA}	312.5	°C/W

■ ELECTRICAL CHARACTERISTICS (Ta =25°C, unless otherwise specified)

PARAMETER	SYMBOL	TEST CONDITIONS	MIN	TYP	MAX	UNIT
OFF CHARACTERISTICS						
Drain-Source Breakdown Voltage	BV _{DSS}	V _{GS} =0V, I _D =10 μA	60			V
Drain-Source Leakage Current	I _{DSS}	V _{DS} =60V, V _{GS} =0V T _J =125°C			1	μA
					0.5	mA
Gate-Body leakage, Forward	I _{GSSF}	V _{GS} =20V, V _{DS} =0V			100	nA
Gate-Body leakage Reverse	I _{GSSR}	V _{GS} =-20V, V _{DS} =0V			-100	nA
ON CHARACTERISTICS (Note)						
Gate Threshold Voltage	V _{GS(TH)}	V _{DS} =V _{GS} , I _D =250μA	1	2.1	2.5	V
Static Drain-Source On-Resistance	R _{DS(ON)}	V _{GS} =10V, I _D =500mA T _J =100°C		1.2	7.5	Ω
		V _{GS} =5.0V, I _D =50mA T _J =100°C		1.7	13.5	
				1.7	7.5	
Drain-Source On-Voltage	V _{DS(ON)}	V _{GS} =10V, I _D =500mA		0.6	3.75	V
		V _{GS} =5.0V, I _D =50mA		0.09	1.5	
On-State Drain Current	I _{D(ON)}	V _{GS} =10V, V _{DS} ≥2V _{DS(ON)}	500	2700		mA
DYNAMIC CHARACTERISTICS						
Input Capacitance	C _{ISS}	V _{DS} =25V, V _{GS} =0V, f=1.0MHz		20	50	pF
Output Capacitance	C _{OSS}			11	25	pF
Reverse Transfer Capacitance	C _{RSS}			4	5	pF
Turn-On Time	t _{ON}	V _{DD} =30V, R _L =150Ω, I _D =200mA, V _{GS} =10V, R _{GEN} =25Ω			20	ns
Turn-Off Time	t _{OFF}	V _{DD} =30V, R _L =150Ω, I _D =200mA, V _{GS} =10V, R _{GEN} =25Ω			20	ns
DRAIN-SOURCE DIODE CHARACTERISTICS AND MAXIMUM RATINGS						
Drain-Source Diode Forward Voltage	V _{SD}	V _{GS} =0V, I _S =115mA(Note)		0.88	1.5	V
Maximum Continuous Drain-Source Diode Forward Current	I _S				115	mA
Maximum Pulsed Drain-Source Diode Forward Current	I _{SM}				0.8	A

Note: Pulse Test: Pulse Width≤300μs, Duty Cycle≤2.0%

■ TYPICAL CHARACTERISTICS

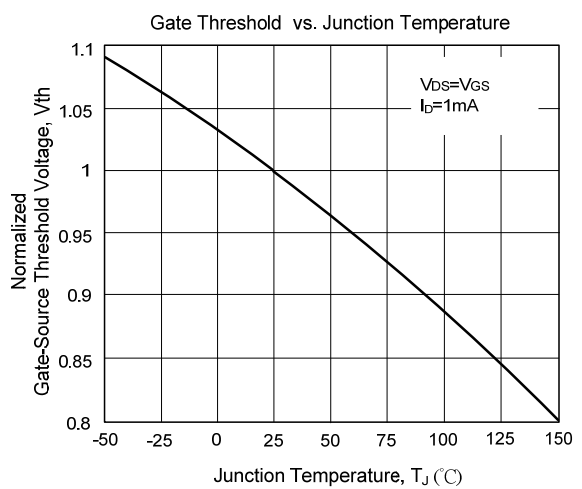
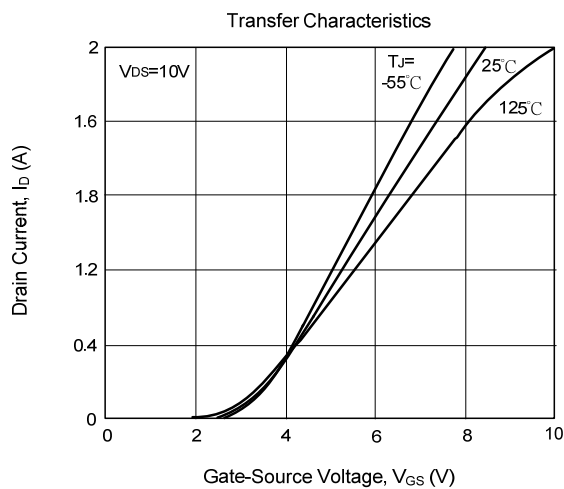
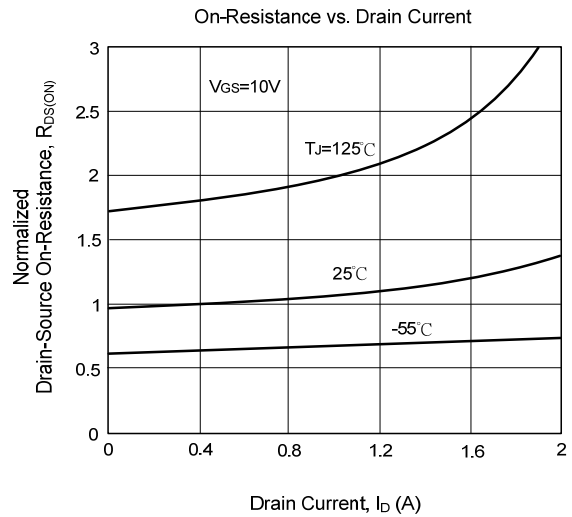
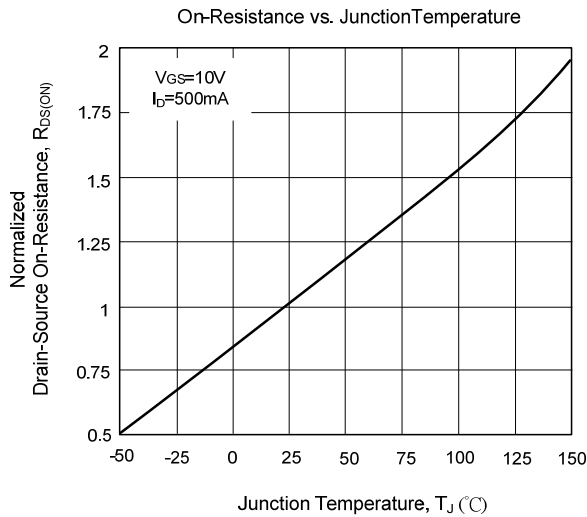
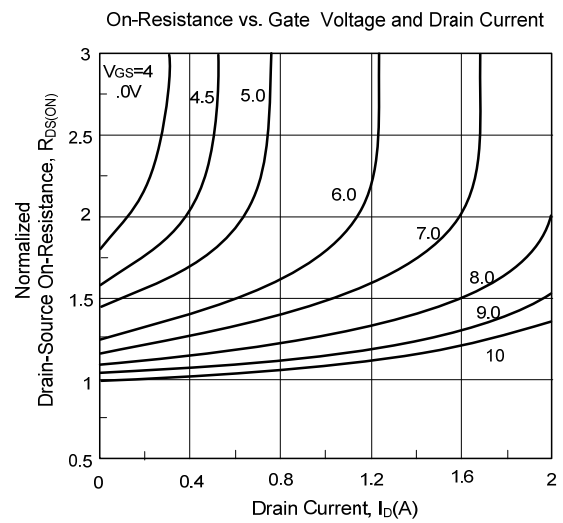
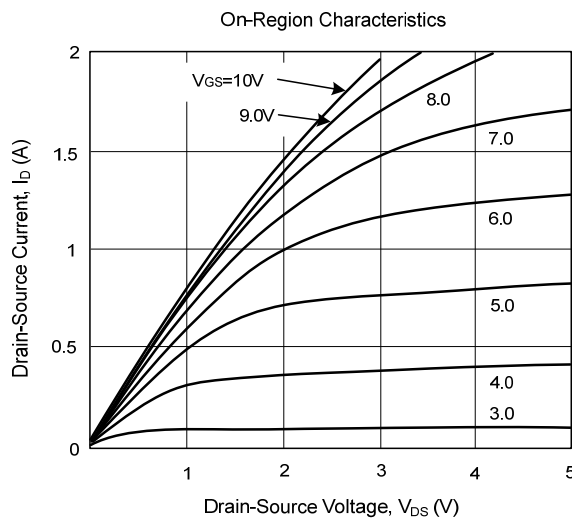

■ TYPICAL CHARACTERISTICS(Cont.)

Breakdown Voltage vs. Junction Temperature

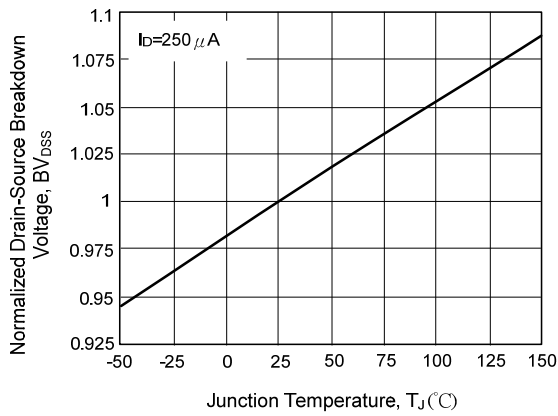

Reverse Drain Current vs. Body Diode Forward Voltage

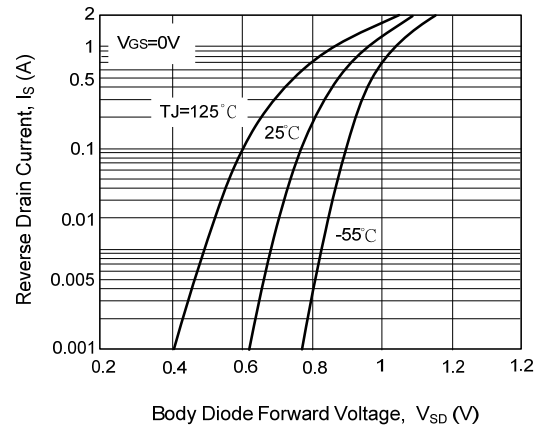

Capacitance Characteristics

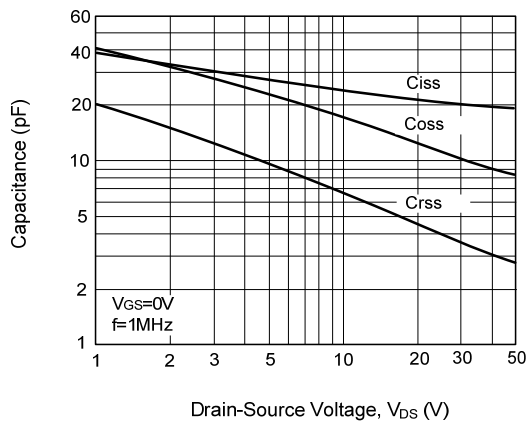

Gate Charge Characteristics

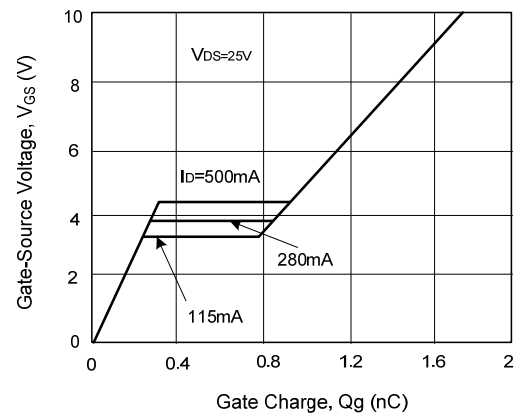

Switching Waveforms

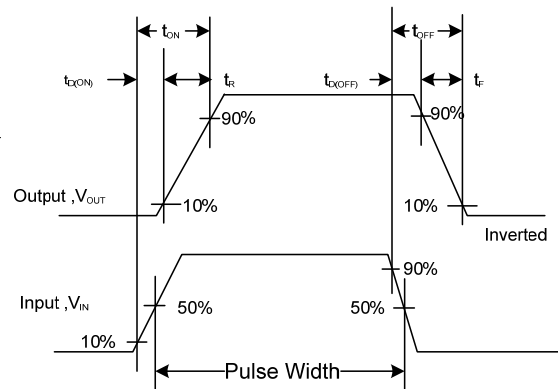
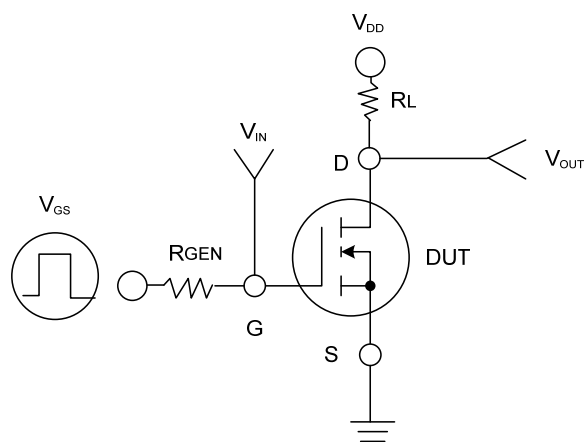

■ TYPICAL CHARACTERISTICS(Cont.)

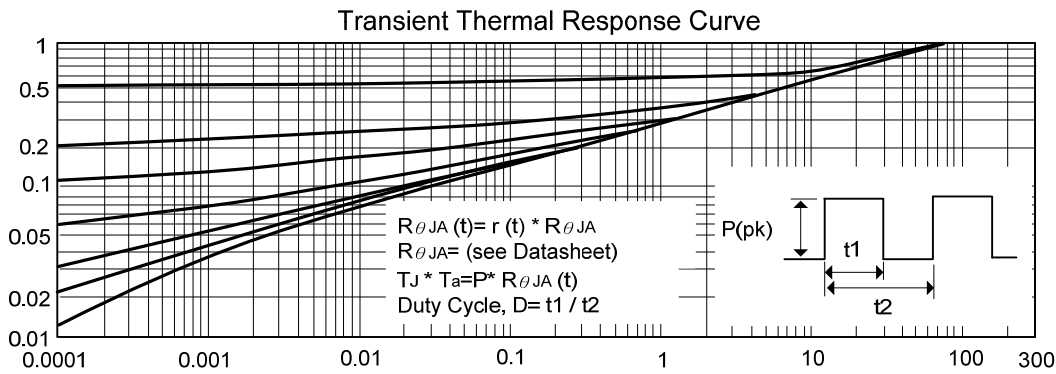
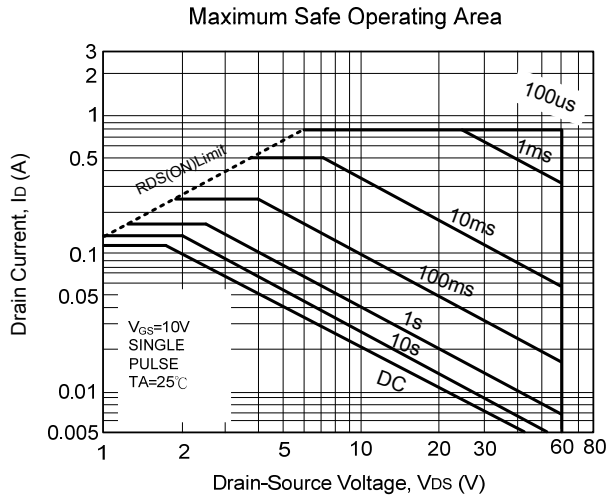

UTC assumes no responsibility for equipment failures that result from using products at values that exceed, even momentarily, rated values (such as maximum ratings, operating condition ranges, or other parameters) listed in products specifications of any and all UTC products described or contained herein. UTC products are not designed for use in life support appliances, devices or systems where malfunction of these products can be reasonably expected to result in personal injury. Reproduction in whole or in part is prohibited without the prior written consent of the copyright owner. The information presented in this document does not form part of any quotation or contract, is believed to be accurate and reliable and may be changed without notice.