

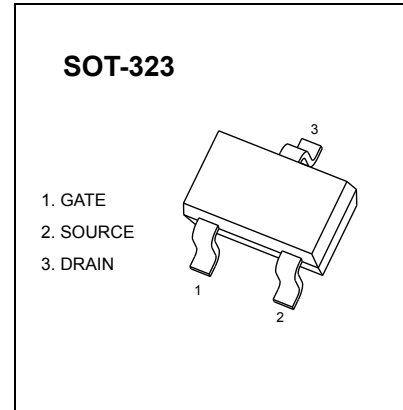

SOT-323 Plastic-Encapsulate MOSFETS

2N7002W MOSFET (N-Channel)

$V_{(BR)DSS}$	$R_{DS(on)MAX}$	I_D
60V	5Ω@10V	115mA
	7Ω@5V	



FEATURE

- High density cell design for low $R_{DS(ON)}$
- Voltage controlled small signal switch
- Rugged and reliable
- High saturation current capability

APPLICATION

- Load Switch for Portable Devices
- DC/DC Converter

MARKING

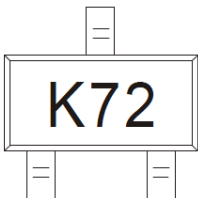

Equivalent Circuit

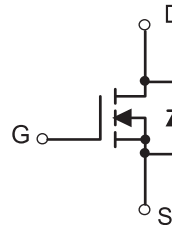

MAXIMUM RATINGS ($T_a=25^{\circ}C$ unless otherwise noted)

Parameter	Symbol	Value	Unit
Drain-Source Voltage	V_{DS}	60	V
Gate-Source Voltage	V_{GS}	± 20	V
Continuous Drain Current	I_D	0.115	A
Power Dissipation	P_D	0.200	W
Thermal Resistance from Junction to Ambient	$R_{\theta JA}$	625	$^{\circ}C/W$
Junction Temperature	T_J	150	$^{\circ}C$
Storage Temperature	T_{stg}	-50 ~ +150	

MOSFET ELECTRICAL CHARACTERISTICS

$T_a=25\text{ }^\circ\text{C}$ unless otherwise specified

Parameter	Symbol	Test conditions	Min	Typ	Max	Unit
Drain-Source Breakdown Voltage	$V_{(BR)DSS}$	$V_{GS}=0\text{ V}, I_D=250\text{ }\mu\text{A}$	60			V
Gate-Threshold Voltage	$V_{(GS)th}$	$V_{DS}=V_{GS}, I_D=250\text{ }\mu\text{A}$	1	1.6	2.5	
Gate-body Leakage	I_{GSS}	$V_{DS}=0\text{ V}, V_{GS}=\pm 20\text{ V}$			± 80	nA
Zero Gate Voltage Drain Current	I_{DSS}	$V_{DS}=60\text{ V}, V_{GS}=0\text{ V}$			80	nA
On-state Drain Current	$I_{D(on)}$	$V_{GS}=10\text{ V}, V_{DS}=7\text{ V}$	500			mA
Drain-Source On-Resistance	$R_{DS(on)}$	$V_{GS}=10\text{ V}, I_D=500\text{mA}$		0.9	5	Ω
		$V_{GS}=5\text{ V}, I_D=50\text{mA}$		1.1	7	
Forward Trans conductance	g_{fs}	$V_{DS}=10\text{ V}, I_D=200\text{mA}$	80			ms
Drain-source on-voltage	$V_{DS(on)}$	$V_{GS}=10\text{V}, I_D=500\text{mA}$			3.75	V
		$V_{GS}=5\text{V}, I_D=50\text{mA}$			0.375	V
Diode Forward Voltage	V_{SD}	$I_S=115\text{mA}, V_{GS}=0\text{ V}$	0.55		1.2	V
Input Capacitance *	C_{iss}	$V_{DS}=25\text{V}, V_{GS}=0\text{V}, f=1\text{MHz}$			50	pF
Output Capacitance *	C_{oss}				25	
Reverse Transfer Capacitance*	C_{rss}				5	

SWITCHING TIME

Turn-on Time*	$t_{d(on)}$	$V_{DD}=25\text{ V}, R_L=50\Omega,$ $I_D=500\text{mA}, V_{GEN}=10\text{ V}$ $R_G=25\Omega$			20	ns
Turn-off Time*	$t_{d(off)}$				40	

*These parameters have no way to verify.

Typical Characteristics

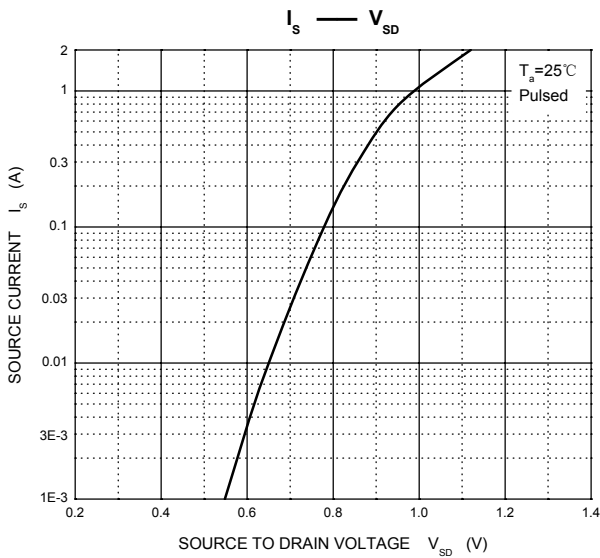
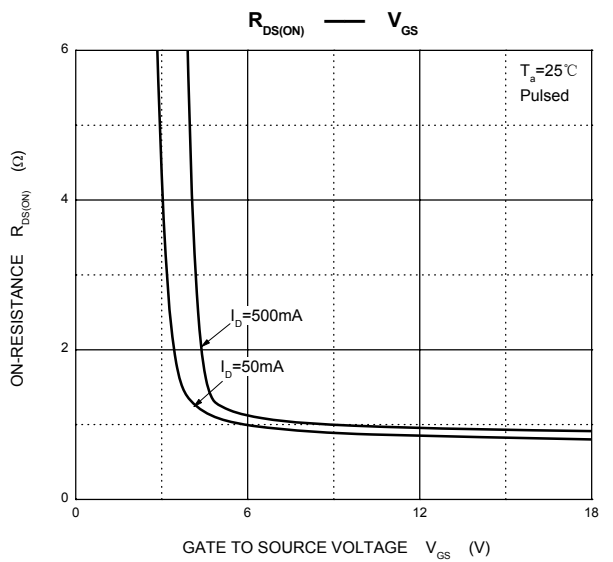
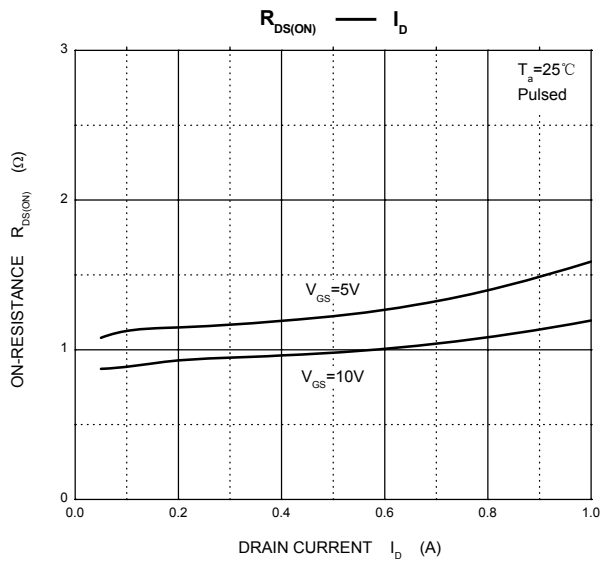
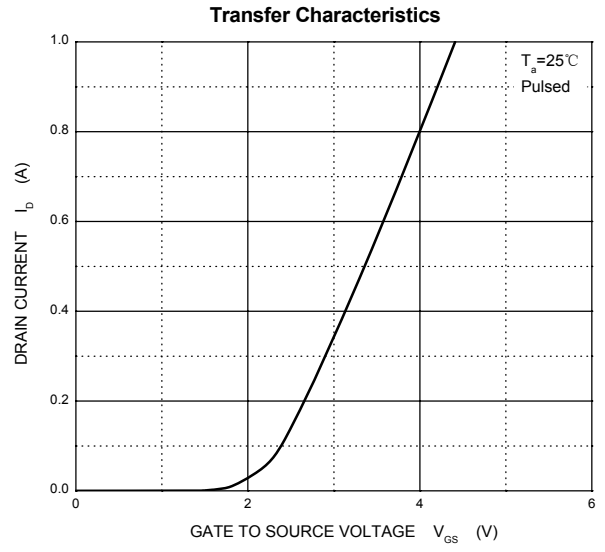
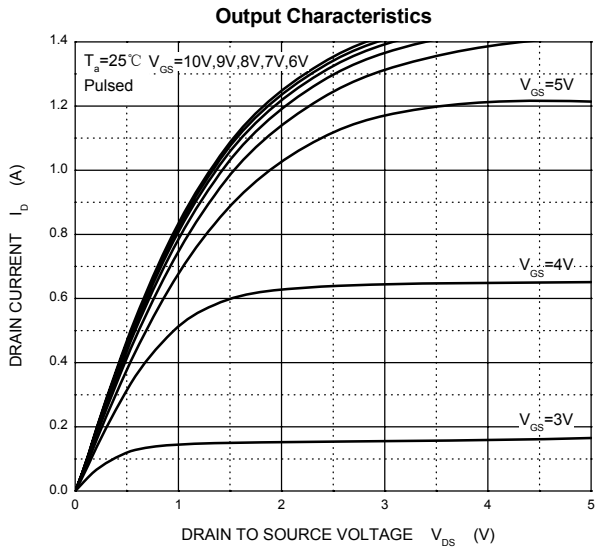

SOT-323 Package Outline Dimensions

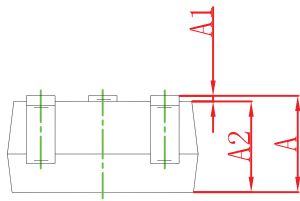
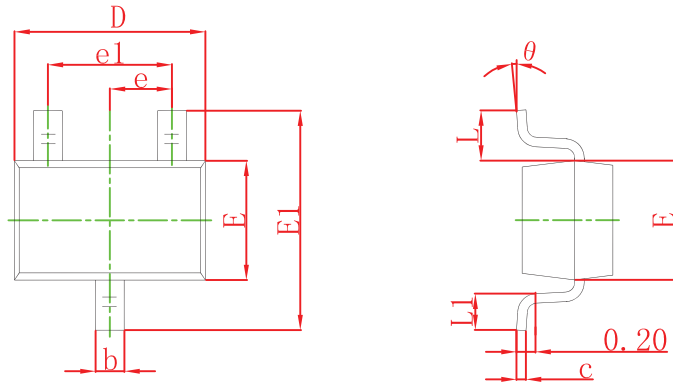

Symbol	Dimensions In Millimeters		Dimensions In Inches	
	Min	Max	Min	Max
A	0.900	1.100	0.035	0.043
A1	0.000	0.100	0.000	0.004
A2	0.900	1.000	0.035	0.039
b	0.200	0.400	0.008	0.016
c	0.080	0.150	0.003	0.006
D	2.000	2.200	0.079	0.087
E	1.150	1.350	0.045	0.053
E1	2.150	2.450	0.085	0.096
e	0.650 TYP		0.026 TYP	
e1	1.200	1.400	0.047	0.055
L	0.525 REF		0.021 REF	
L1	0.260	0.460	0.010	0.018
θ	0°	8°	0°	8°

SOT-323 Suggested Pad Layout

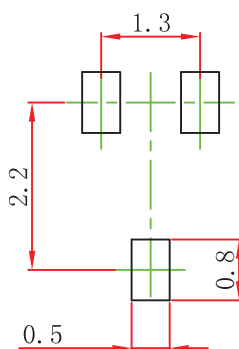

Note:

1. Controlling dimension: in millimeters.
2. General tolerance: ± 0.05 mm.
3. The pad layout is for reference purposes only.

NOTICE

JCET reserve the right to make modifications, enhancements, improvements, corrections or other changes without further notice to any product herein. JCET does not assume any liability arising out of the application or use of any product described herein.

SOT-323 Tape and reel

SOT-323 Embossed Carrier Tape

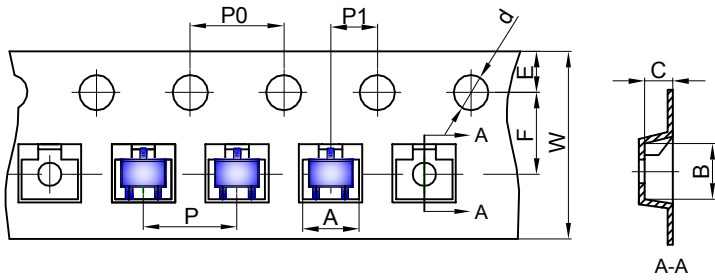

Packaging Description:
 SOT-323 parts are shipped in tape. The carrier tape is made from a dissipative (carbon filled) polycarbonate resin. The cover tape is a multilayer film (Heat Activated Adhesive in nature) primarily composed of polyester film, adhesive layer, sealant, and anti-static sprayed agent. These reeled parts in standard option are shipped with 3,000 units per 7" or 17.8cm diameter reel. The reels are clear in color and is made of polystyrene plastic (anti-static coated).

Dimensions are in millimeter										
Pkg type	A	B	C	d	E	F	P0	P	P1	W
SOT-323	2.25	2.55	1.19	Ø1.55	1.75	3.50	4.00	4.00	2.00	8.00

SOT-323 Tape Leader and Trailer

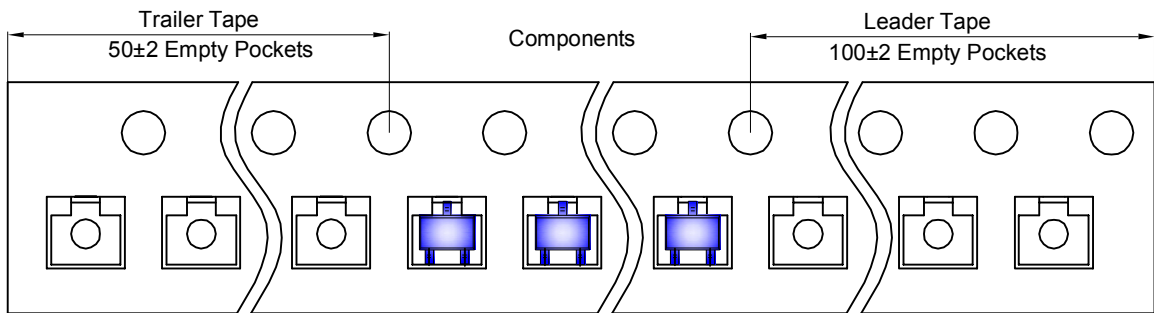

SOT-323 Reel

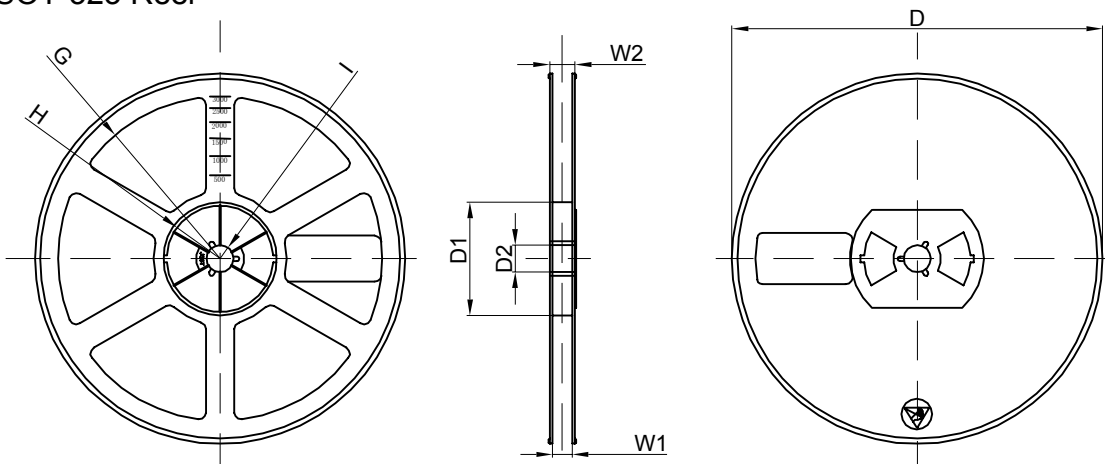

Dimensions are in millimeter								
Reel Option	D	D1	D2	G	H	I	W1	W2
7" Dia	Ø178.00	54.40	13.00	R78.00	R25.60	R6.50	9.50	12.30

REEL	Reel Size	Box	Box Size(mm)	Carton	Carton Size(mm)	G.W.(kg)
3000 pcs	7 inch	30,000 pcs	203×203×195	120,000 pcs	438×438×220	