

RoHS Compliant Product
A suffix of "-C" specifies halogen & lead-free

FEATURES

- $R_{DS(ON)}$, $V_{GS}@10V$, $I_{DS}@500mA=3\Omega$
- $R_{DS(ON)}$, $V_{GS}@4.5V$, $I_{DS}@200mA=4\Omega$
- Advanced Trench Process Technology
- High Density Cell Design For Ultra Low On-Resistance
- Very Low Leakage Current In Off Condition
- Specially Designed for Battery Operated Systems, Solid-State Relays Drivers : Relays, Displays, Lamps, Solenoids, Memories, etc.
- ESD Protected 2KV HBM
- In compliance with EU RoHS 2002/95/EC directives

SOT-323

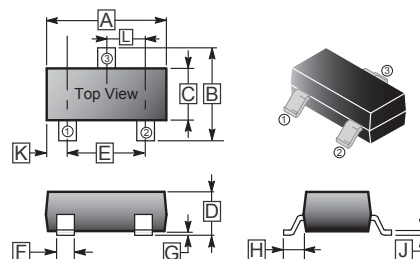

MECHANICAL DATA

- Case: SOT-323 Package
- Terminals: Solderable per MIL-STD-750, Method 2026

REF.	Millimeter		REF.	Millimeter	
	Min.	Max.		Min.	Max.
A	1.80	2.20	G	0.100 REF.	
B	1.80	2.45	H	0.525 REF.	
C	1.15	1.35	J	0.08	0.25
D	0.80	1.10	K	-	-
E	1.20	1.40	L	0.650 TYP.	
F	0.20	0.40			

MARKING

K72

PACKAGE INFORMATION

Package	MPQ	LeaderSize
SOT-323	3K	7' inch

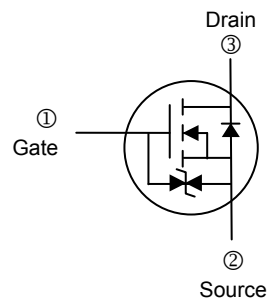

ABSOLUTE MAXIMUM RATINGS ($T_A = 25^\circ C$ unless otherwise specified)

Parameter	Symbol	Rating	Unit
Drain-Source Voltage	V_{DS}	60	V
Gate-Source Voltage	V_{GS}	± 20	V
Continuous Drain Current	I_D	115	mA
Pulsed Drain Current ¹	I_{DM}	800	mA
Maximum Power Dissipation	P_D	$T_A=25^\circ C$	200
		$T_A=75^\circ C$	120
Thermal Resistance Junction-Ambient (PCB mounted) ²	$R_{\theta JA}$	625	$^\circ C / W$
Operating Junction and Storage Temperature	T_J, T_{STG}	-55~150	$^\circ C$

Notes:

1. Maximum DC current limited by the package.
2. Surface mounted on FR4 board, $t < 5sec$.

N-CHANNEL ELECTRICAL CHARACTERISTICS ($T_A = 25^\circ\text{C}$ unless otherwise specified)

Parameter	Symbol	Min.	Typ. ²	Max.	Unit	Test Conditions
Static						
Drain-Source Breakdown Voltage	BV_{DSS}	60	-	-	V	$V_{GS}=0, I_D=10\mu\text{A}$
Gate-Threshold Voltage	$V_{GS(th)}$	1	-	2.5	V	$V_{DS}=V_{GS}, I_D=250\mu\text{A}$
Drain-Source On-Resistance	$R_{DS(ON)}$	-	-	4	Ω	$V_{GS}=4.5\text{V}, I_D=200\text{mA}$
		-	-	3		$V_{GS}=10\text{V}, I_D=500\text{mA}$
Zero Gate Voltage Drain Current	I_{DSS}	-	-	1	μA	$V_{DS}=60\text{V}, V_{GS}=0$
Gate-Body Leakage Current	I_{GSS}	-	-	± 10	μA	$V_{DS}=0, V_{GS}= \pm 20\text{V}$
Forward Transconductance	g_{fs}	100	-	-	mS	$V_{DS}=15\text{V}, I_D=250\text{mA}$
Dynamic						
Total Gate Charge	Q_g	-	-	0.8	nC	$V_{DS}=15\text{V}, V_{GS}=4.5\text{V}, I_D=200\text{mA}$
Turn-On Time	$t_{(on)}$	-	-	20	nS	$V_{DD}=30\text{V}, R_L=150\Omega, I_D=200\text{mA}, V_{GEN}=10\text{V}, R_G=10\Omega$
Turn-Off Time	$t_{(off)}$	-	-	40		
Input Capacitance	C_{iss}	-	-	35	pF	$V_{DS}=25\text{V}, V_{GS}=0\text{V}, f=1\text{MHz}$
Output Capacitance	C_{oss}	-	-	10		
Reverse Transfer Capacitance	C_{rss}	-	-	5		
Source-Drain Diode						
Diode Forward Voltage	V_{SD}	-	0.82	1.3	V	$I_S=200\text{mA}, V_{GS}=0\text{V}$
Continuous Diode Forward Current	I_S	-	-	115	mA	
Pulse Diode Forward Current	I_{SM}	-	-	800	mA	

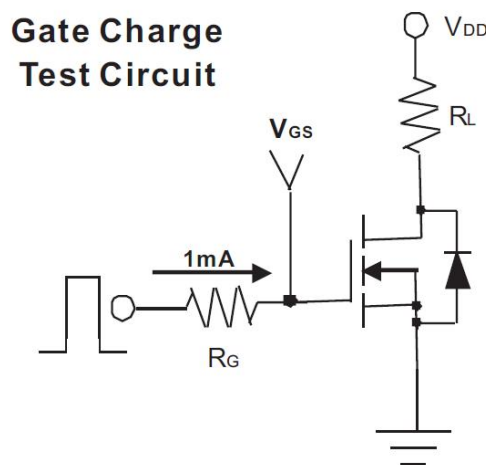
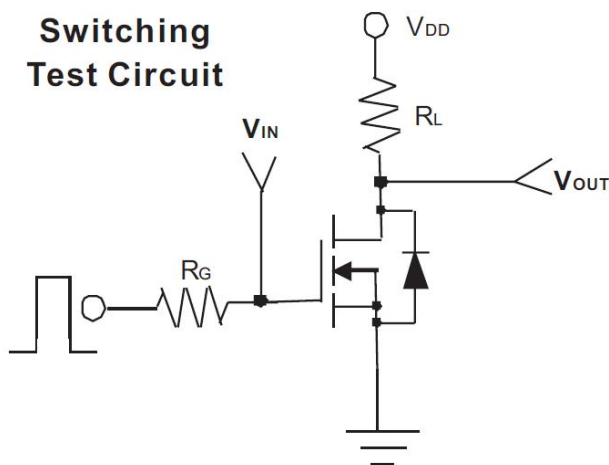

CHARACTERISTIC CURVE

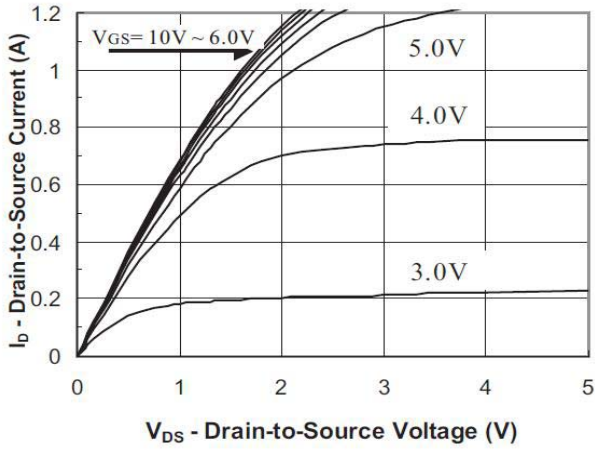

FIG.1-Output Characteristic

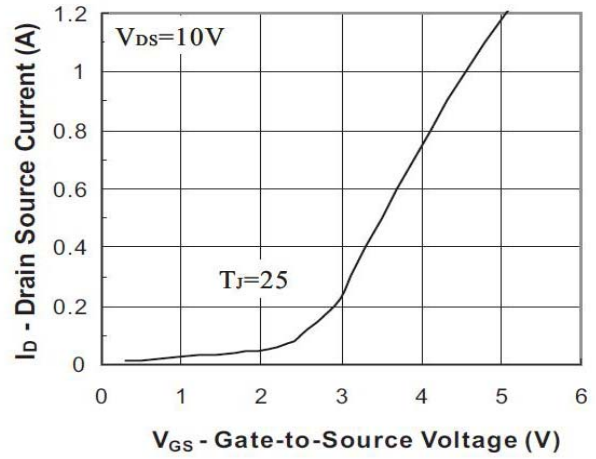

FIG.2-Transfer Characteristic

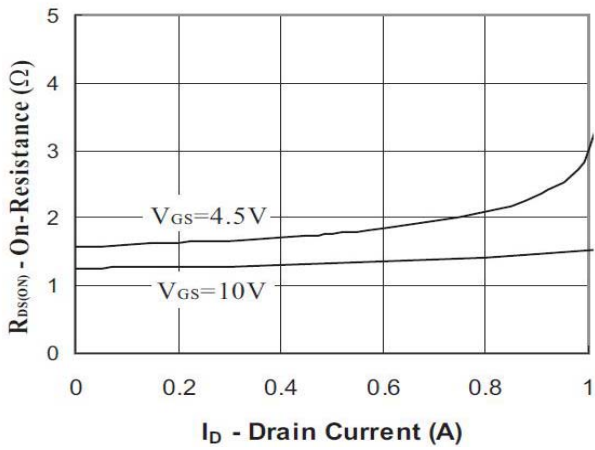

FIG.3-On Resistance vs Drain Current

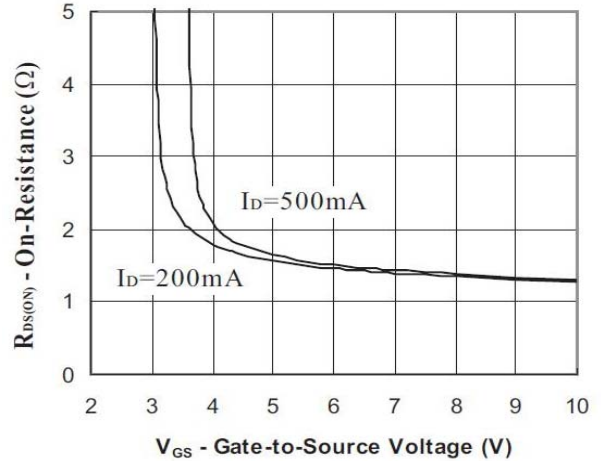

FIG.4- On Resistance vs Gate to Source Voltage

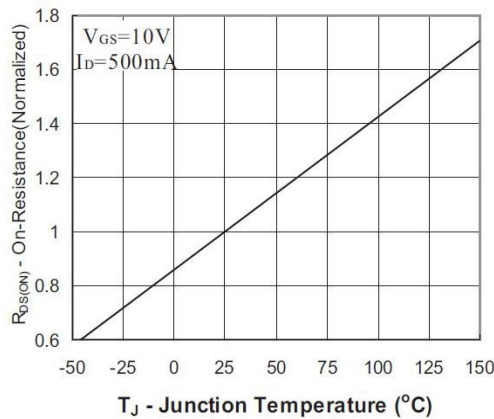

FIG.5-On Resistance vs Junction Temperature

CHARACTERISTIC CURVE

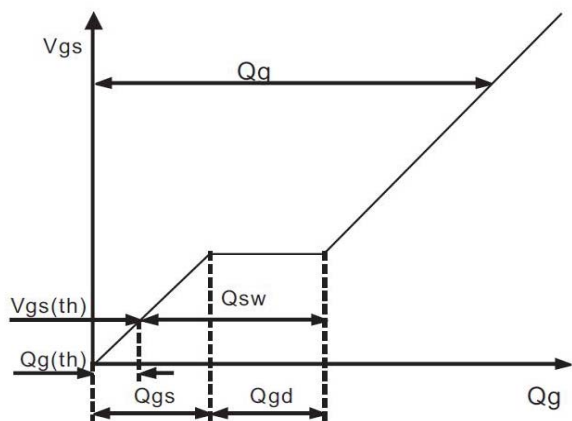

FIG.6-Gate Charge Waveform

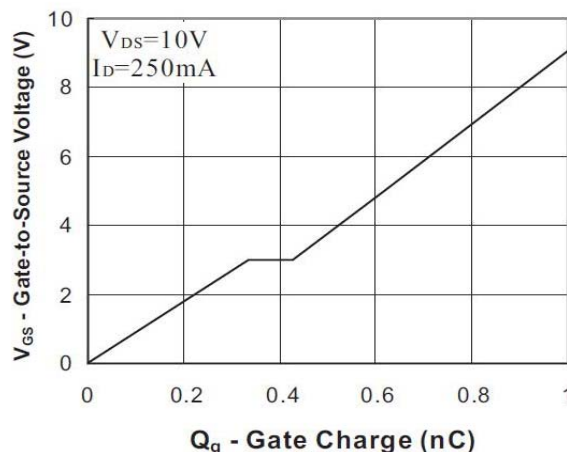

FIG.7-Gate Charge

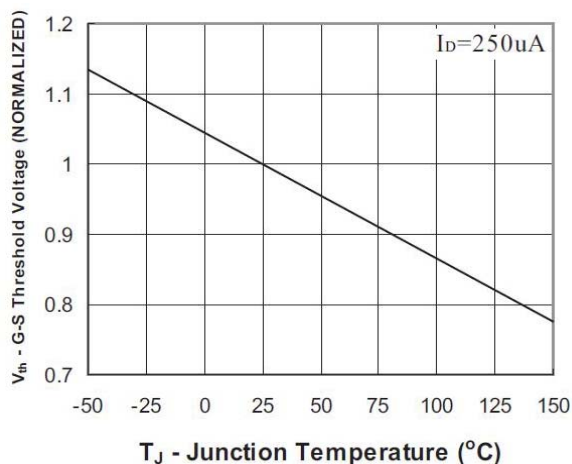

FIG.8-Threshold Voltage vs Temperature

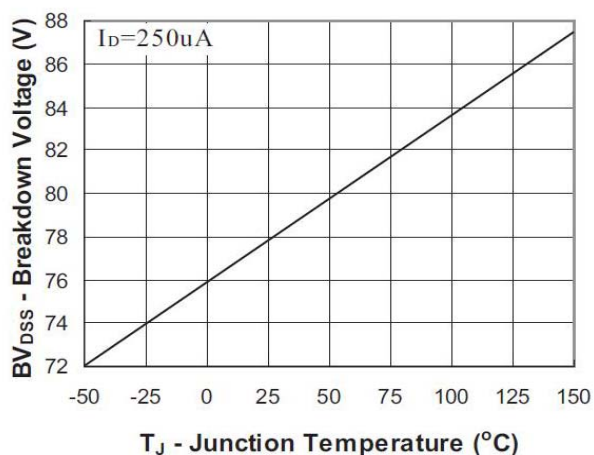

FIG.9-Breakdown Voltage vs Junction Temperature

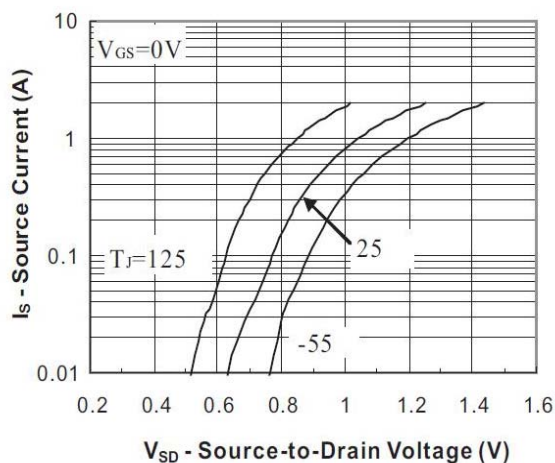

FIG.10-Source-Drain Diode Forward Voltage