

Features

Pb-Free Packages are Available

MAXIMUM RATINGS

Rating	Symbol	Value	Unit
Drain-Source Voltage	V_{DSS}	60	Vdc
Drain-Gate Voltage (RGS=1.0M Ω)	V_{DGR}	60	Vdc
Drain Current	I_D	± 115	mAdc
-Continuous TC=25 (Note 1)	I_D	± 75	
TC=100 (Note 1)	I_{DM}	± 800	
-Pulsed (Note 2)			
Gate-Source Voltage	V_{GS}	± 20	Vdc
-Continuous	V_{GSM}	± 40	Vpk
-Non-repetitive ($t_p \leq 50\mu s$)			

Maximum ratings are those values beyond which device damage can occur. Maximum ratings applied to the device are individual stress limit values (not normal operating conditions) and are not valid simultaneously. If these limits are exceeded, device functional operation is not implied, damage may occur and reliability may be affected.

THERMAL CHARACTERISTICS

Characteristic	Symbol	Max	Unit
Total Device Dissipation FR-5 Board (Note 3) TA=25 Derate above 25	P_D	225 1.8	mW mW/
Thermal Resistance, Junction to Ambient	$R_{\theta JA}$	556	/W
Total Device Dissipation Alumina Substrate, (Note 4) TA=25 Derate above 25	P_D	300 2.4	mW mW/
Thermal Resistance, Junction to Ambient	$R_{\theta JA}$	417	/W
Junction and Storage Temperature	TJ, Tstg	-55 to +150	

1. The Power Dissipation of the package may result in a lower continuous drain current.
2. Pulse Test: Pulse Width $\leq 300\mu s$, Duty Cycle $\leq 2.0\%$.
3. FR-5 = 1.0 X 0.75 X 0.062 in.
4. Alumina = 0.4 x 0.3 x 0.025 in 99.5% alumina.

$V_{(BR)DSS}$	$R_{DS(on)MAX}$	$I_D MAX$
60V	7.5 Ω @ 10V,500mA	115mA

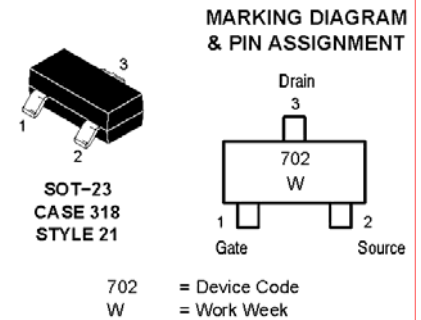
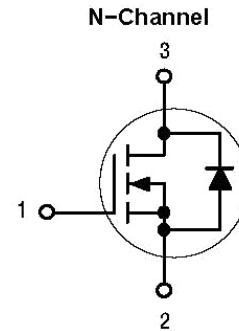

ORDERING INFORMATION

Device	Package	Shipping†
2N7002LT1	SOT-23	3000 Tape & Reel
2N7002LT3		10,000 Tape & Reel
2N7002LT1G	SOT-23 (Pb-free)	3000 Tape & Reel
2N7002LT3G		10,000 Tape & Reel

†For information on tape and reel specifications, including part orientation and tape sizes, please refer to our tape and Reel Packaging Specifications Brochure, BRD8011/D

ELECTRICAL CHARACTERISTICS ($T_A=25$ unless otherwise noted)

Characteristic	Symbol	Min	Typ	Max	Unit	
OFF CHARACTERISTICS						
Drain-Source Breakdown Voltage ($V_{GS}=0, I_D=10\mu\text{Adc}$)	$V_{(BR)DSS}$	60	-	-	Vdc	
Zero Gate Voltage Drain Current ($V_{GS}=0, V_{DS}=60\text{Vdc}$)	I_{DSS}	-	-	1.0	μAdc	
				500		
Gate-Body Leakage Current, Forward ($V_{GS}=20\text{Vdc}$)	I_{GSSF}	-	-	100	nAdc	
Gate-Body Leakage Current, Forward ($V_{GS}=-20\text{Vdc}$)	I_{GSSR}	-	-	-100	nAdc	
ON CHARACTERISTICS (Note 5)						
Gate Threshold Voltage ($V_{DS}=V_{GS}, I_D=250\mu\text{Adc}$)	$V_{GS(th)}$	1.0	-	2.5	Vdc	
On-State Drain Current ($V_{DS}\geq 2.0V_{DS(on)}, V_{GS}=10\text{Vdc}$)	$I_{D(on)}$	500	-	-	mA	
Static Drain-Source On-State Voltage ($V_{DS}=V_{GS}, I_D=500\mu\text{Adc}$)	$V_{DS(on)}$	-	-	3.75	Vdc	
		-	-	0.375		
Static Drain-Source On-State Resistance ($V_{GS}=10\text{V}, I_D=500\text{mAdc}$)	$r_{DS(on)}$	-	-	7.5	Ohms	
		-	-	13.5		
		-	-	7.5		
		-	-	13.5		
Forward Transconductance ($V_{DS}\geq 2.0 V_{DS(on)}, I_D=200\text{mAdc}$)	g_{FS}	80	-	-	mmhos	
DYNAMIC CHARACTERISTICS						
Input Capacitance ($V_{DS}=25\text{Vdc}, V_{GS}=0, f=1.0\text{MHz}$)	C_{iss}	-	-	50	pF	
Output Capacitance ($V_{DS}=25\text{Vdc}, V_{GS}=0, f=1.0\text{MHz}$)	C_{oss}	-	-	25	pF	
Reverse Transfer Capacitance ($V_{DS}=25\text{Vdc}, V_{GS}=0, f=1.0\text{MHz}$)	C_{rss}	-	-	5.0	pF	
SWITCHING CHARACTERISTICS (Note 5)						
Turn-On Delay Time	($V_{DD}=25\text{Vdc}, I_D\approx 500\text{mAdc}, R_G=25\Omega,$ $R_L=50\Omega, V_{gen}=10\text{V}$)	$t_{d(on)}$	-	-	20	ns
Turn-Off Delay Time		$t_{d(off)}$	-	-	40	ns
BODY-DRAIN DIODE RATINGS						
Diode Forward On-Voltage ($I_S=11.5\text{mAdc}, V_{GS}=0\text{V}$)	V_{SD}	-	-	-1.5	Vdc	
Source Current Continuous (Body Diode)	I_S	-	-	-115	mAdc	
Source Current Pulsed	I_{SM}	-	-	-800	mAdc	

5.Pulse Test: Pulse Width $\leq 300\mu\text{s}$, Duty Cycle $\leq 2.0\%$.

TYPICAL ELECTRICAL CHARACTERISTICS

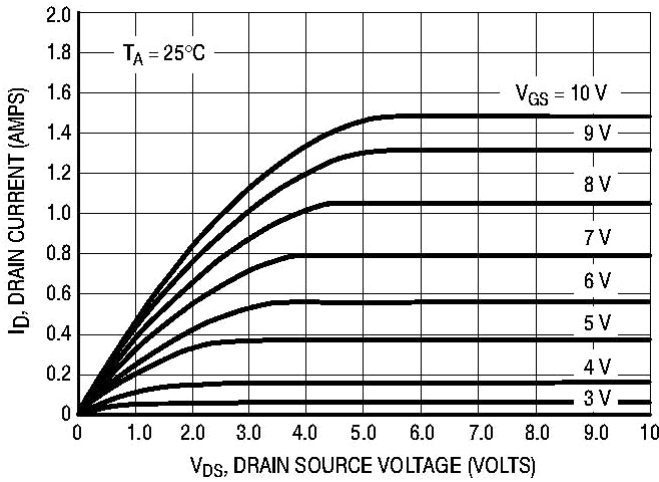

Figure 1. Ohmic Region

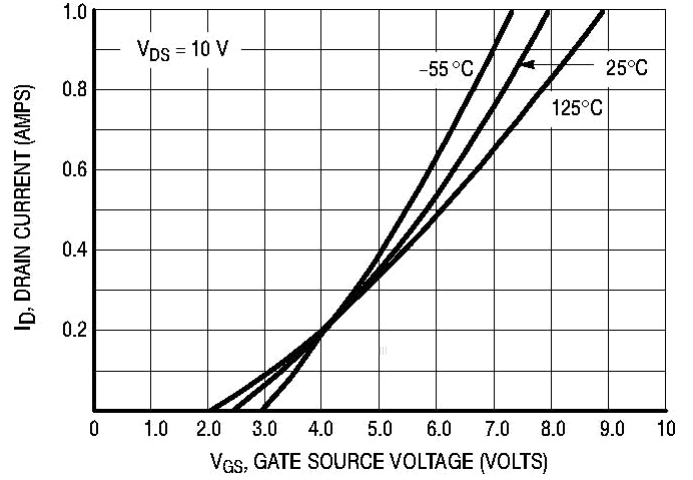

Figure 2. Transfer Characteristics

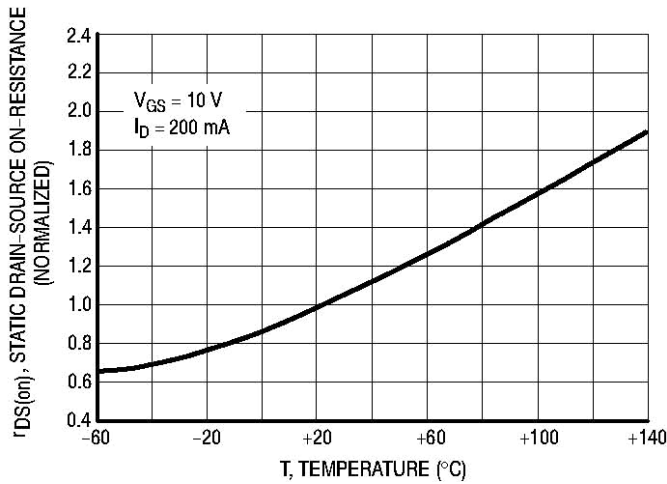

Figure 3. Temperature versus Static Drain-Source On-Resistance

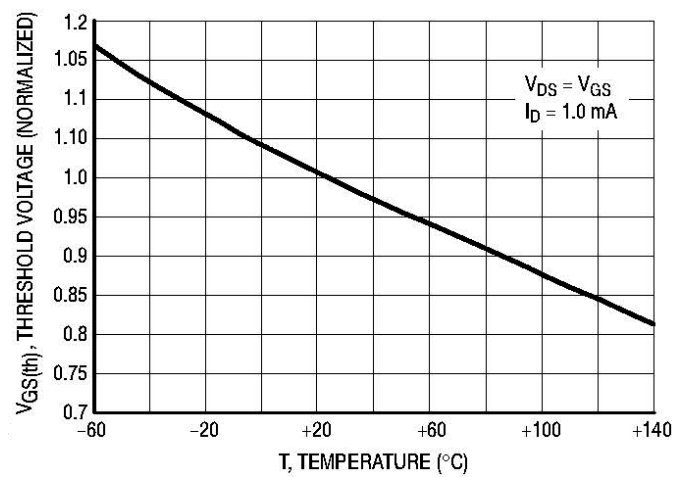

Figure 4. Temperature versus Gate Threshold Voltage

PACKAGE DIMENSIONS

SOT-23 (TO-236)

CASE 318-08

ISSUE AH

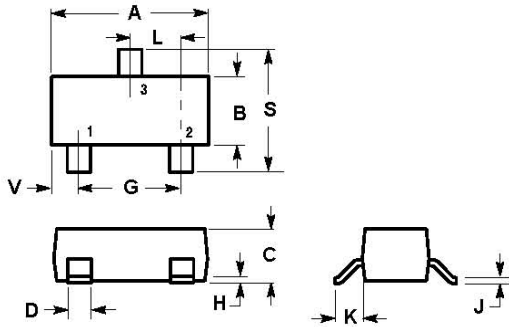

NOTES:

1. DIMENSIONING AND TOLERANCING PER ANSI Y14.5M, 1982.
2. CONTROLLING DIMENSION: INCH.
3. MAXIMUM LEAD THICKNESS INCLUDES LEAD FINISH THICKNESS. MINIMUM LEAD THICKNESS IS THE MINIMUM THICKNESS OF BASE MATERIAL.
4. 318-03 AND -07 OBSOLETE, NEW STANDARD 318-08.

DIM	INCHES		MILLIMETERS	
	MIN	MAX	MIN	MAX
A	0.1102	0.1197	2.80	3.04
B	0.0472	0.0551	1.20	1.40
C	0.0350	0.0440	0.89	1.11
D	0.0150	0.0200	0.37	0.50
G	0.0701	0.0807	1.78	2.04
H	0.0005	0.0040	0.013	0.100
J	0.0034	0.0070	0.085	0.177
K	0.0140	0.0285	0.35	0.69
L	0.0350	0.0401	0.89	1.02
S	0.0830	0.1039	2.10	2.64
V	0.0177	0.0236	0.45	0.60

STYLE21:

- PIN1. GATE**
- 2.SOURCE**
- 3.DRAIN**

SOLDERING FOOTPRINT*

