

**RADIATION HARDENED
 POWER MOSFET
 THRU-HOLE (Low-Ohmic TO-257AA)**

**2N7588T3
 IRHYS67130CM
 100V, N-CHANNEL**



Product Summary

Part Number	Radiation Level	RDS(on)	ID
IRHYS67130CM	100K Rads (Si)	0.042Ω	20A*
IRHYS63130CM	300K Rads (Si)	0.042Ω	20A*

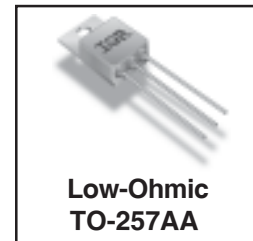

International Rectifier's R6™ technology provides superior power MOSFETs for space applications. These devices have improved immunity to Single Event Effect (SEE) and have been characterized for useful performance with Linear Energy Transfer (LET) up to 90MeV/(mg/cm²). Their combination of very low RDS(on) and faster switching times reduces power loss and increases power density in today's high speed switching applications such as DC-DC converters and motor controllers. These devices retain all of the well established advantages of MOSFETs such as voltage control, ease of paralleling and temperature stability of electrical parameters.

Features:

- Low RDS(on)
- Fast Switching
- Single Event Effect (SEE) Hardened
- Low Total Gate Charge
- Simple Drive Requirements
- Ease of Paralleling
- Hermetically Sealed
- Ceramic Eyelets
- Electrically Isolated
- Light Weight

Absolute Maximum Ratings

Pre-Irradiation

	Parameter		Units
ID @ VGS = 12V, TC = 25°C	Continuous Drain Current	20*	A
ID @ VGS = 12V, TC = 100°C	Continuous Drain Current	19	
IDM	Pulsed Drain Current ①	80	
PD @ TC = 25°C	Max. Power Dissipation	75	W
	Linear Derating Factor	0.6	W/°C
VGS	Gate-to-Source Voltage	±20	V
EAS	Single Pulse Avalanche Energy ②	107	mJ
IAR	Avalanche Current ①	20	A
EAR	Repetitive Avalanche Energy ①	7.5	mJ
dv/dt	Peak Diode Recovery dv/dt ③	5.5	V/ns
TJ	Operating Junction	-55 to 150	°C
TSTG	Storage Temperature Range		
	Lead Temperature	300 (0.063 in. /1.6 mm from case for 10s)	
	Weight	4.3 (Typical)	g

* Current is limited by package
 For footnotes refer to the last page

Electrical Characteristics @ T_j = 25°C (Unless Otherwise Specified)

	Parameter	Min	Typ	Max	Units	Test Conditions
B _V D _{SS}	Drain-to-Source Breakdown Voltage	100	—	—	V	V _{GS} = 0V, I _D = 1.0mA
ΔB _V D _{SS} /ΔT _J	Temperature Coefficient of Breakdown Voltage	—	0.12	—	V/°C	Reference to 25°C, I _D = 1.0mA
R _{DS(on)}	Static Drain-to-Source On-State Resistance	—	—	0.042	Ω	V _{GS} = 12V, I _D = 19A ④
V _{GS(th)}	Gate Threshold Voltage	2.0	—	4.0	V	V _{DS} = V _{GS} , I _D = 1.0mA
ΔV _{GS(th)} /ΔT _J	Gate Threshold Voltage Coefficient	—	-8.72	—	mV/°C	
g _{fs}	Forward Transconductance	14	—	—	S	V _{DS} = 10V, I _{DS} = 19A ④
I _{DSS}	Zero Gate Voltage Drain Current	—	—	10	μA	V _{DS} = 80V, V _{GS} = 0V
		—	—	25		V _{DS} = 80V, V _{GS} = 0V, T _J = 125°C
I _{GSS}	Gate-to-Source Leakage Forward	—	—	100	nA	V _{GS} = 20V
I _{GSS}	Gate-to-Source Leakage Reverse	—	—	-100	nA	V _{GS} = -20V
Q _g	Total Gate Charge	—	—	50	nC	V _{GS} = 12V, I _D = 20A
Q _{gs}	Gate-to-Source Charge	—	—	15		V _{DS} = 50V
Q _{gd}	Gate-to-Drain ('Miller') Charge	—	—	12		
t _{d(on)}	Turn-On Delay Time	—	—	20	ns	V _{DD} = 50V, I _D = 20A, V _{GS} = 12V, R _G = 7.5Ω
t _r	Rise Time	—	—	50		
t _{d(off)}	Turn-Off Delay Time	—	—	35		
t _f	Fall Time	—	—	15		
L _S + L _D	Total Inductance	—	6.8	—	nH	Measured from Drain lead (6mm / 0.025 in from package) to Source lead (6mm/ 0.025 in from package)
C _{iss}	Input Capacitance	—	1710	—	pF	V _{GS} = 0V, V _{DS} = 25V f = 1.0MHz
C _{oss}	Output Capacitance	—	343	—		
C _{rss}	Reverse Transfer Capacitance	—	6.5	—		
R _g	Gate Resistance	—	1.1	—	Ω	f = 1.0MHz, open drain

Source-Drain Diode Ratings and Characteristics

	Parameter	Min	Typ	Max	Units	Test Conditions
I _S	Continuous Source Current (Body Diode)	—	—	20*	A	
I _{SM}	Pulse Source Current (Body Diode) ①	—	—	80		
V _{SD}	Diode Forward Voltage	—	—	1.2	V	T _j = 25°C, I _S = 20A, V _{GS} = 0V ④
t _{rr}	Reverse Recovery Time	—	—	250	ns	T _j = 25°C, I _F = 20A, di/dt ≤ 100A/μs
Q _{RR}	Reverse Recovery Charge	—	—	2.7	μC	V _{DD} ≤ 25V ④
t _{on}	Forward Turn-On Time	Intrinsic turn-on time is negligible. Turn-on speed is substantially controlled by L _S + L _D .				

* Current is limited by package

Thermal Resistance

	Parameter	Min	Typ	Max	Units	Test Conditions
R _{thJC}	Junction-to-Case	—	—	1.67	°C/W	
R _{thJA}	Junction-to-Ambient	—	—	80		Typical Socket Mount

Note: Corresponding Spice and Saber models are available on International Rectifier Web site.

For footnotes refer to the last page

Radiation Characteristics

IRHYS67130CM, 2N7588T3

International Rectifier Radiation Hardened MOSFETs are tested to verify their radiation hardness capability. The hardness assurance program at International Rectifier is comprised of two radiation environments. Every manufacturing lot is tested for total ionizing dose (per notes 5 and 6) using the TO-3 package. Both pre- and post-irradiation performance are tested and specified using the same drive circuitry and test conditions in order to provide a direct comparison.

Table 1. Electrical Characteristics @ Tj = 25°C, Post Total Dose Irradiation ⑤⑥

	Parameter	Up to 300K Rads (Si) ¹		Units	Test Conditions
		Min	Max		
BV _{DSS}	Drain-to-Source Breakdown Voltage	100	—	V	V _{GS} = 0V, I _D = 1.0mA
V _{GS(th)}	Gate Threshold Voltage	2.0	4.0		V _{GS} = V _{DS} , I _D = 1.0mA
I _{GSS}	Gate-to-Source Leakage Forward	—	100	nA	V _{GS} = 20V
I _{GSS}	Gate-to-Source Leakage Reverse	—	-100		V _{GS} = -20V
I _{DSS}	Zero Gate Voltage Drain Current	—	10	μA	V _{DS} = 80V, V _{GS} = 0V
R _{DS(on)}	Static Drain-to-Source On-State Resistance (TO-3) ④	—	0.044	Ω	V _{GS} = 12V, I _D = 19A
R _{DS(on)}	Static Drain-to-Source On-State Resistance (Low Ohmic TO-257) ④	—	0.042	Ω	V _{GS} = 12V, I _D = 19A
V _{SD}	Diode Forward Voltage ④	—	1.2	V	V _{GS} = 0V, I _D = 20A

1. Part numbers IRHYS67130CM and IRHYS63130CM

International Rectifier radiation hardened MOSFETs have been characterized in heavy ion environment for Single Event Effects (SEE). Single Event Effects characterization is illustrated in Fig. a and Table 2.

Table 2. Typical Single Event Effect Safe Operating Area

LET (MeV/(mg/cm ²))	Energy (MeV)	Range (μm)	V _{DS} (V)					
			@V _{GS} = 0V	@V _{GS} = -5V	@V _{GS} = -10V	@V _{GS} = -15V	@V _{GS} = -19V	@V _{GS} = -20V
39 ± 5%	315 ± 5%	40 ± 5%	100	100	100	100	100	40
61 ± 5%	345 ± 5%	32 ± 7.5%	100	100	100	30	-	-
90 ± 5%	375 ± 7.5%	29 ± 7.5%	100	100	-	-	-	-

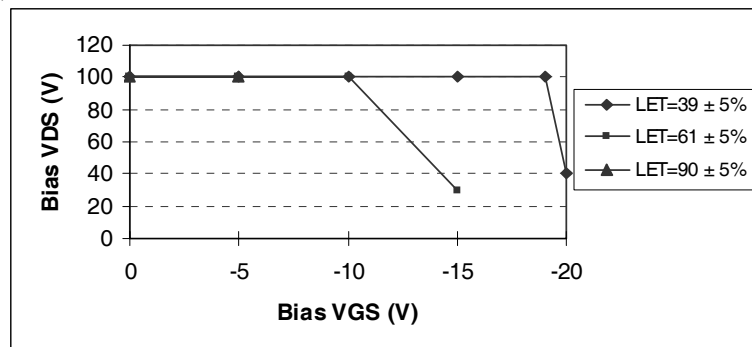

Fig a. Typical Single Event Effect, Safe Operating Area

For footnotes refer to the last page

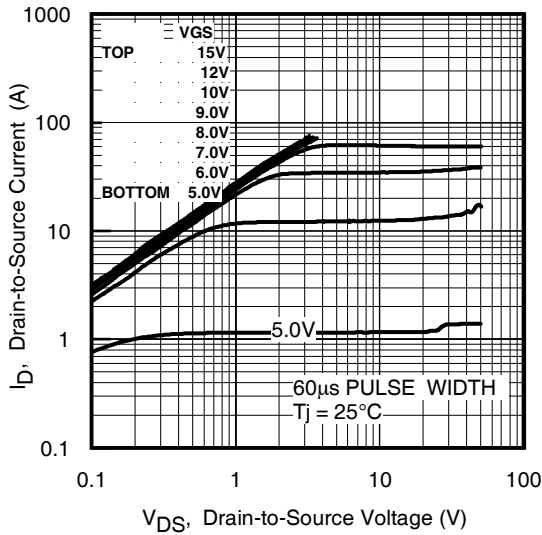

Fig 1. Typical Output Characteristics

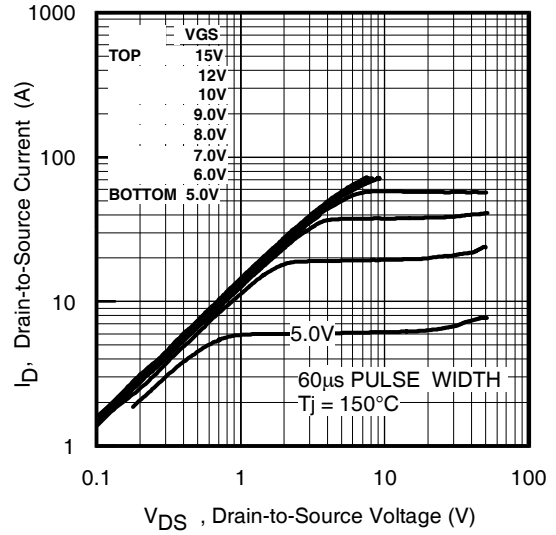

Fig 2. Typical Output Characteristics

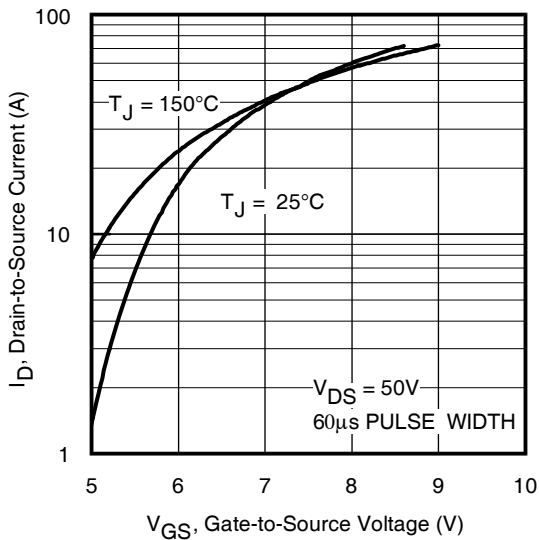

Fig 3. Typical Transfer Characteristics

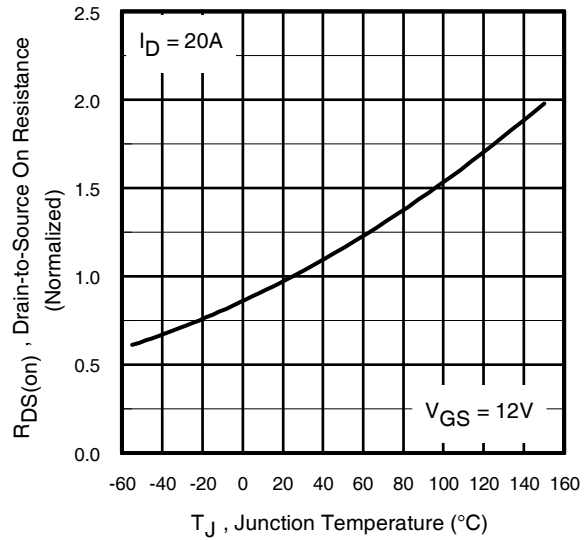

Fig 4. Normalized On-Resistance Vs. Temperature

Pre-Irradiation

IRHYS67130CM, 2N7588T3

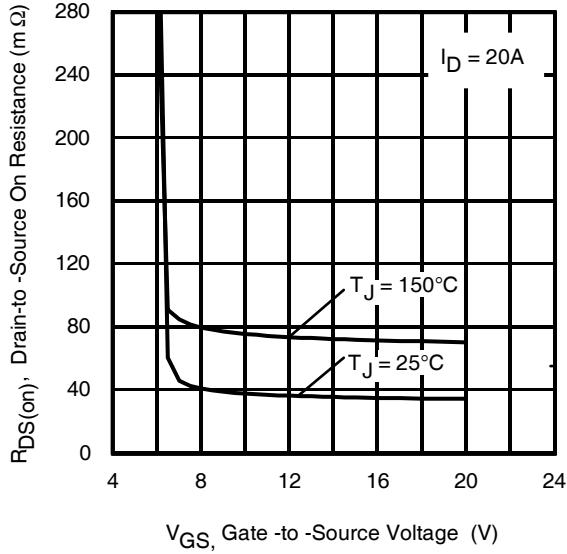

Fig 5. Typical On-Resistance Vs Gate Voltage

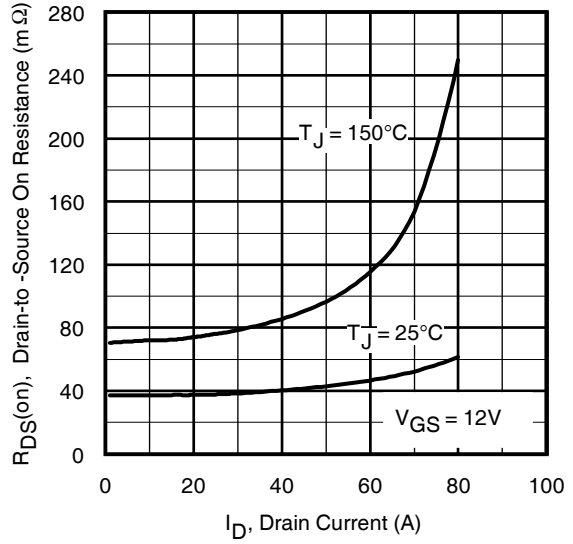

Fig 6. Typical On-Resistance Vs Drain Current

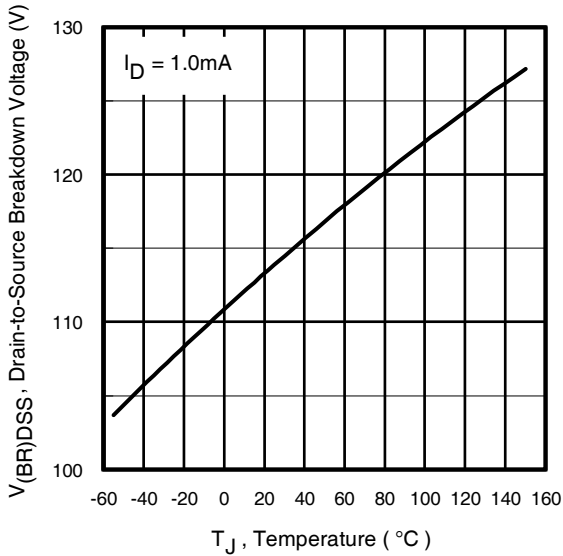

Fig 7. Typical Drain-to-Source Breakdown Voltage Vs Temperature

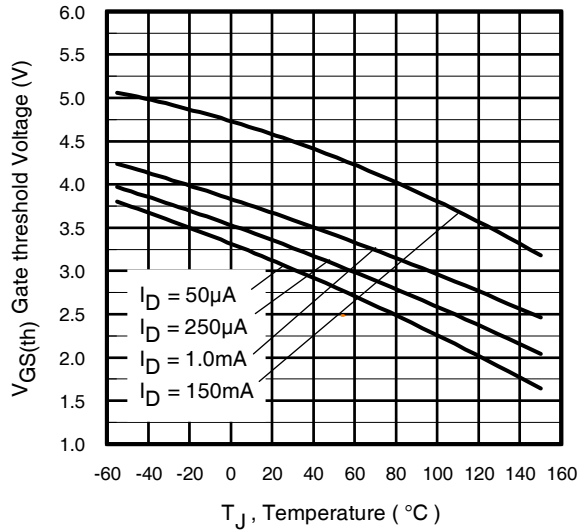

Fig 8. Typical Threshold Voltage Vs Temperature

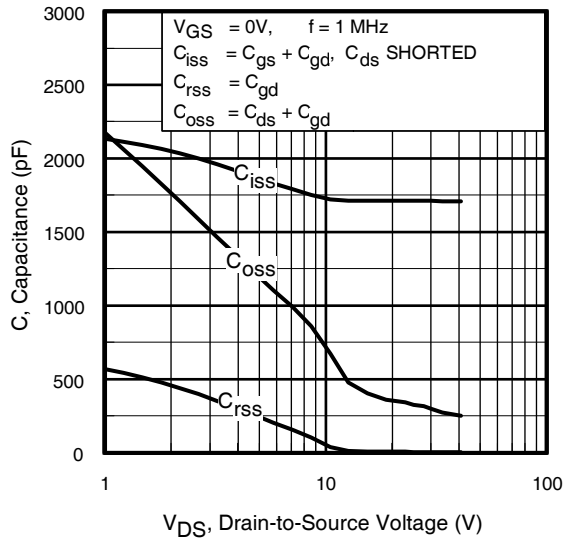

Fig 9. Typical Capacitance Vs. Drain-to-Source Voltage

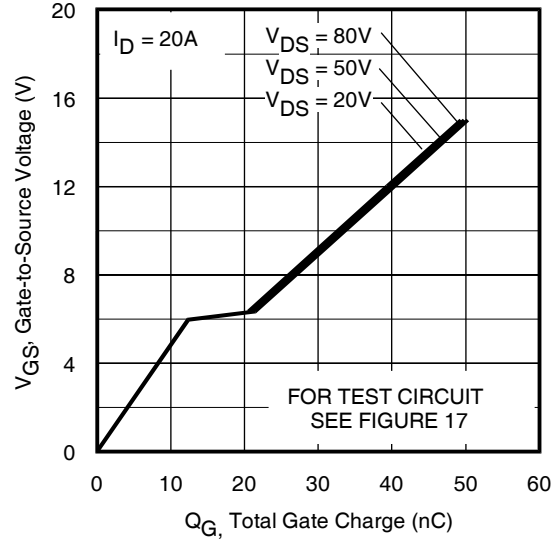

Fig 10. Typical Gate Charge Vs. Gate-to-Source Voltage

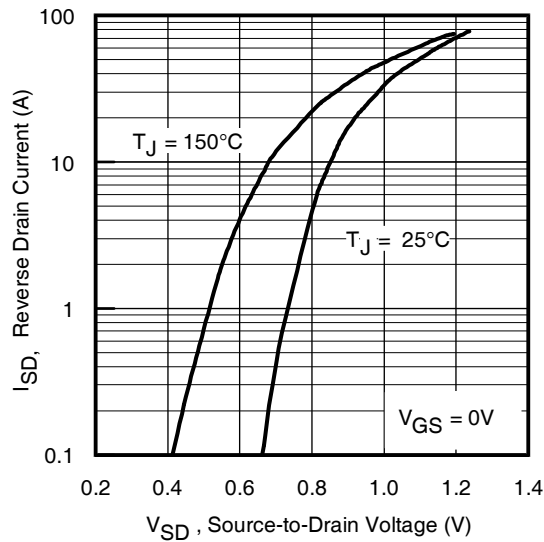

Fig 11. Typical Source-Drain Diode Forward Voltage

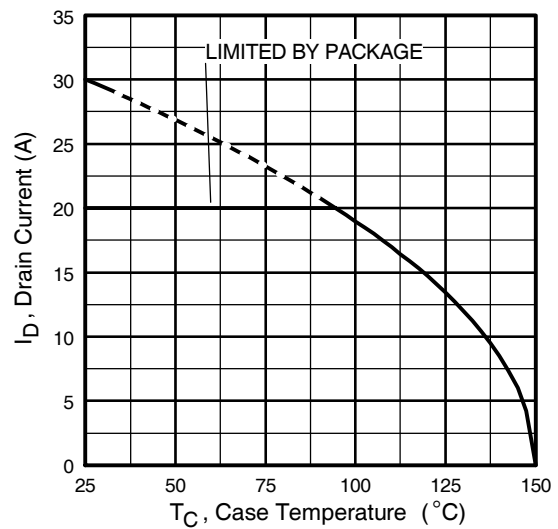

Fig 12. Maximum Drain Current Vs. Case Temperature

Pre-Irradiation

IRHYS67130CM, 2N7588T3

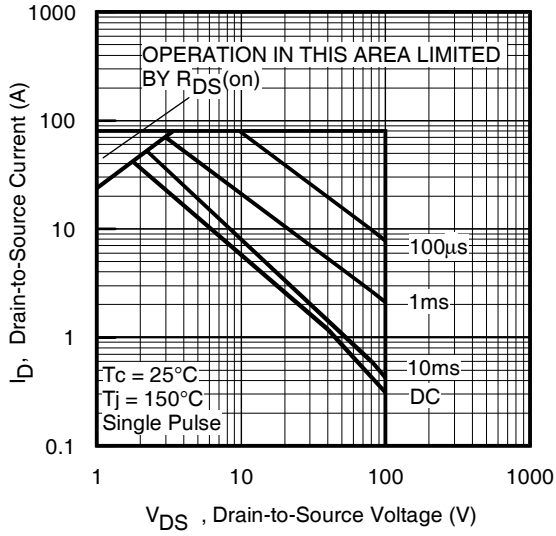

Fig 13. Maximum Safe Operating Area

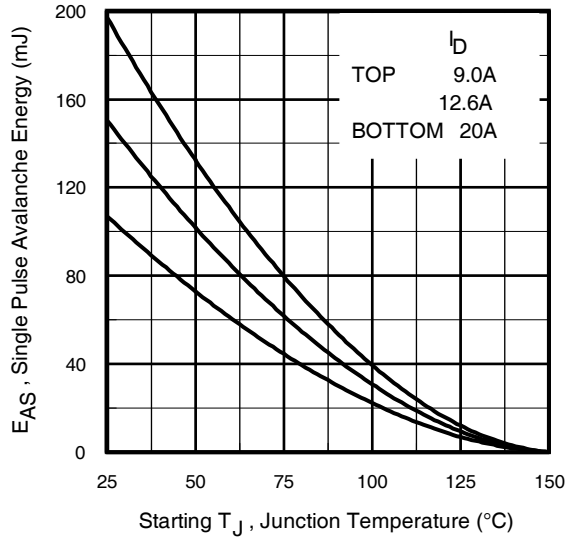

Fig 14. Maximum Avalanche Energy Vs. Drain Current

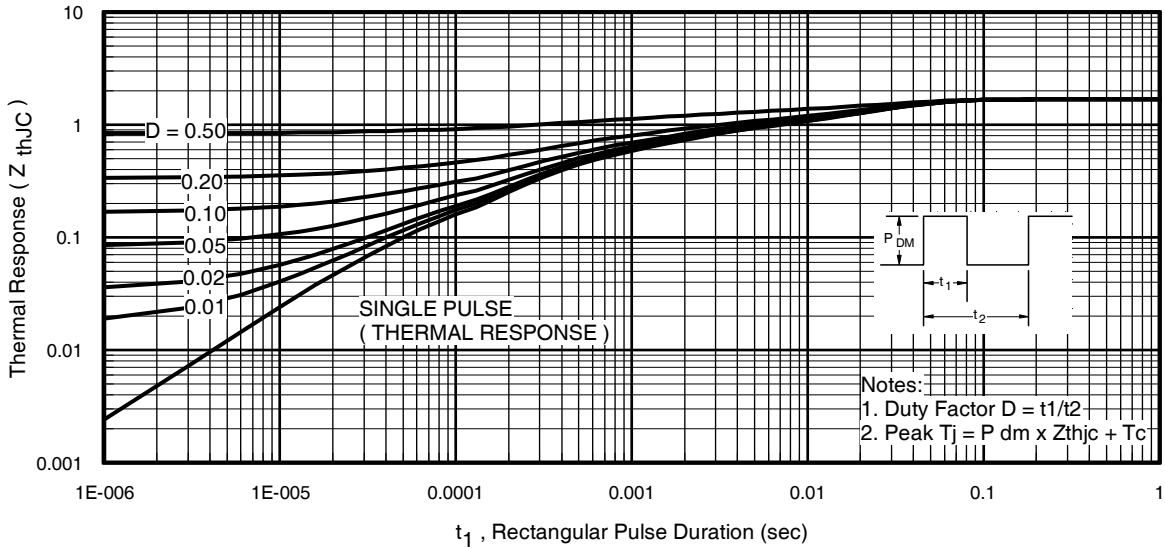

Fig 15. Maximum Effective Transient Thermal Impedance, Junction-to-Case

IRHYS67130CM, 2N7588T3

Pre-Irradiation

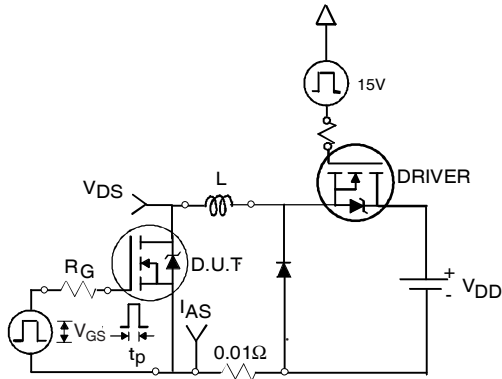

Fig 16a. Unclamped Inductive Test Circuit

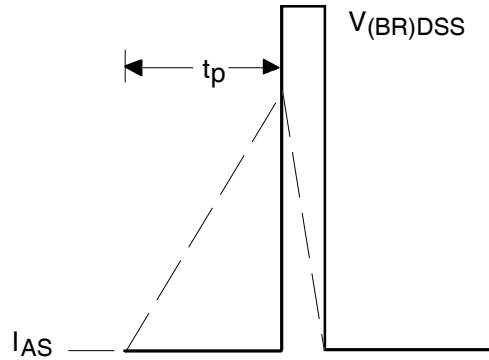

Fig 16b. Unclamped Inductive Waveforms

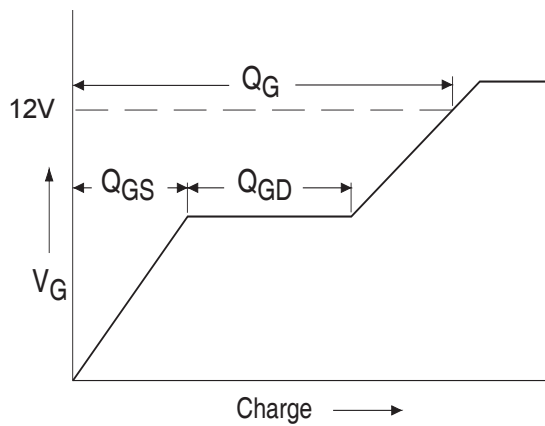

Fig 17a. Basic Gate Charge Waveform

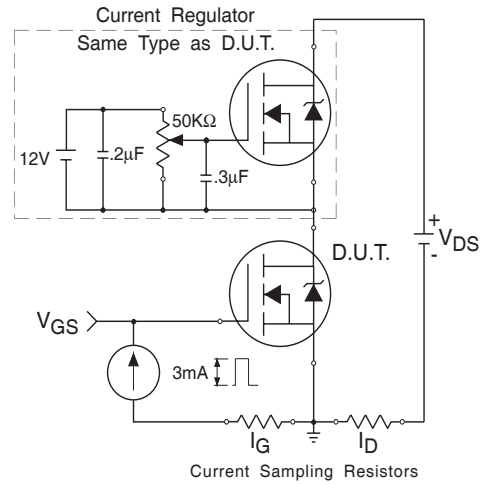

Fig 17b. Gate Charge Test Circuit

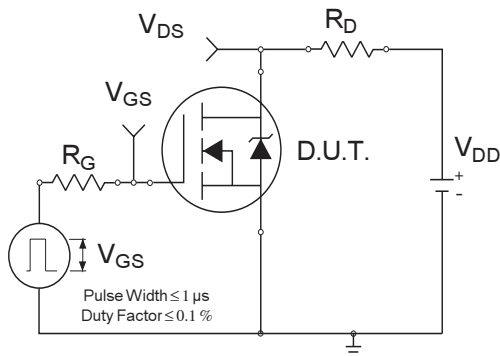

Fig 18a. Switching Time Test Circuit

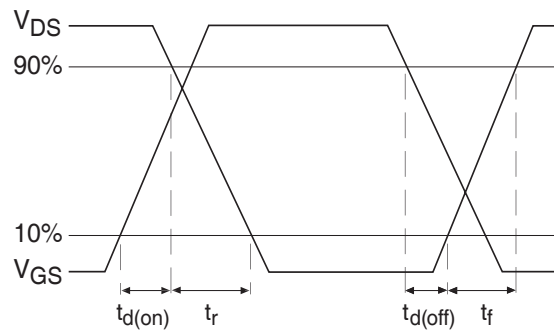

Fig 18b. Switching Time Waveforms

Pre-Irradiation

IRHYS67130CM, 2N7588T3

Footnotes:

- ① Repetitive Rating; Pulse width limited by maximum junction temperature.
- ② $V_{DD} = 25V$, starting $T_J = 25^\circ C$, $L = 0.54mH$
Peak $I_L = 20A$, $V_{GS} = 12V$
- ③ $I_{SD} \leq 20A$, $di/dt \leq 575A/\mu s$,
 $V_{DD} \leq 100V$, $T_J \leq 150^\circ C$
- ④ Pulse width $\leq 300 \mu s$; Duty Cycle $\leq 2\%$
- ⑤ **Total Dose Irradiation with V_{GS} Bias.**
12 volt V_{GS} applied and $V_{DS} = 0$ during irradiation per MIL-STD-750, method 1019, condition A.
- ⑥ **Total Dose Irradiation with V_{DS} Bias.**
80 volt V_{DS} applied and $V_{GS} = 0$ during irradiation per MIL-STD-750, method 1019, condition A.

Case Outline and Dimensions — Low-Ohmic TO-257AA

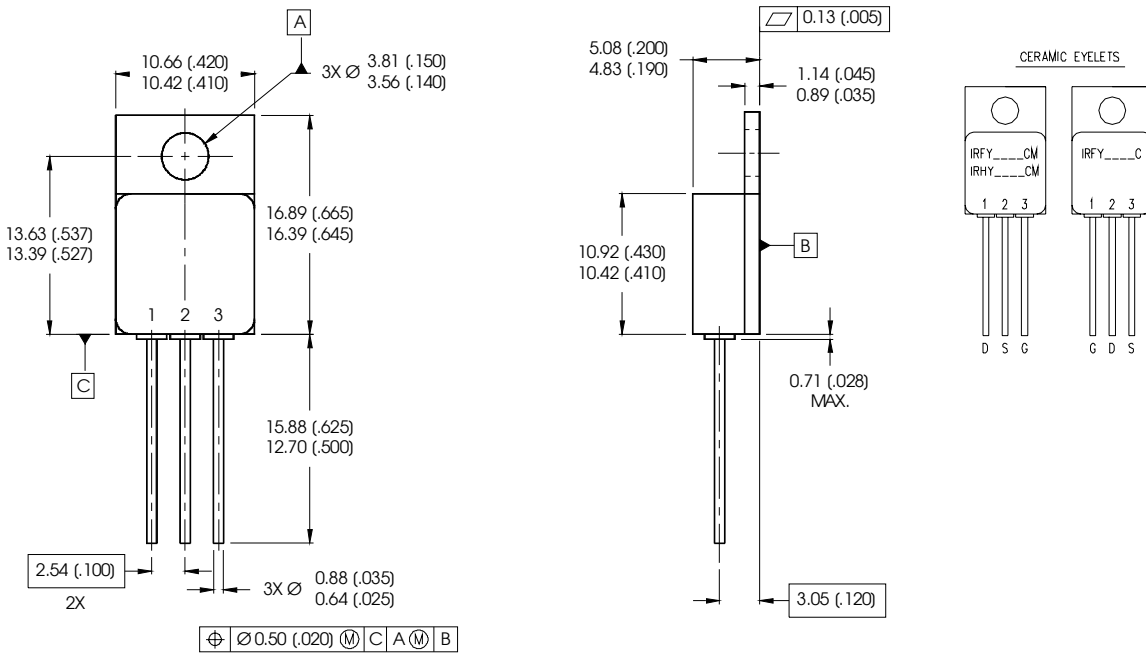

NOTES:

1. DIMENSIONING & TOLERANCING PER ANSI Y14.5M-1994.
2. CONTROLLING DIMENSION: INCH.
3. DIMENSIONS ARE SHOWN IN MILLIMETERS (INCHES).
4. OUTLINE CONFORMS TO JEDEC OUTLINE TO-257AA.

LEAD ASSIGNMENTS

- 1 = DRAIN
- 2 = SOURCE
- 3 = GATE

International
IR Rectifier

IR WORLD HEADQUARTERS: 233 Kansas St., El Segundo, California 90245, USA Tel: (310) 252-7105

IR LEOMINSTER : 205 Crawford St., Leominster, Massachusetts 01453, USA Tel: (978) 534-5776

TAC Fax: (310) 252-7903

Visit us at www.irf.com for sales contact information.

Data and specifications subject to change without notice. 06/2010