

**RADIATION HARDENED  
 POWER MOSFET  
 THRU-HOLE (Low-Ohmic TO-257AA)**

**2N7592T3  
 IRHYS67230CM  
 200V, N-CHANNEL**



**Product Summary**

Part Number	Radiation Level	RDS(on)	ID
IRHYS67230CM	100K Rads (Si)	0.13Ω	16A
IRHYS63230CM	300K Rads (Si)	0.13Ω	16A

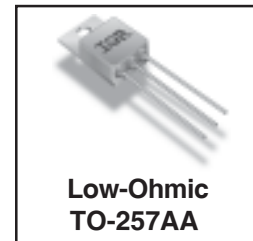

International Rectifier's R6™ technology provides superior power MOSFETs for space applications. These devices have improved immunity to Single Event Effect (SEE) and have been characterized for useful performance with Linear Energy Transfer (LET) up to 90MeV/(mg/cm²). Their combination of very low RDS(on) and faster switching times reduces power loss and increases power density in today's high speed switching applications such as DC-DC converters and motor controllers. These devices retain all of the well established advantages of MOSFETs such as voltage control, ease of paralleling and temperature stability of electrical parameters.

**Features:**

- Low RDS(on)
- Fast Switching
- Single Event Effect (SEE) Hardened
- Low Total Gate Charge
- Simple Drive Requirements
- Ease of Paralleling
- Hermetically Sealed
- Ceramic Eyelets
- Electrically Isolated
- Light Weight

**Absolute Maximum Ratings**

**Pre-Irradiation**

	Parameter		Units
ID @ VGS = 12V, TC = 25°C	Continuous Drain Current	16	A
ID @ VGS = 12V, TC = 100°C	Continuous Drain Current	10	
IDM	Pulsed Drain Current ①	64	
PD @ TC = 25°C	Max. Power Dissipation	75	W
	Linear Derating Factor	0.6	W/°C
VGS	Gate-to-Source Voltage	±20	V
EAS	Single Pulse Avalanche Energy ②	83	mJ
IAR	Avalanche Current ①	16	A
EAR	Repetitive Avalanche Energy ①	7.5	mJ
dv/dt	Peak Diode Recovery dv/dt ③	9.0	V/ns
TJ	Operating Junction	-55 to 150	°C
TSTG	Storage Temperature Range		
	Lead Temperature	300 (0.063 in. /1.6 mm from case for 10s)	
	Weight	4.3 (Typical)	g

For footnotes refer to the last page

www.irf.com

**Electrical Characteristics @ T<sub>j</sub> = 25°C (Unless Otherwise Specified)**

	Parameter	Min	Typ	Max	Units	Test Conditions
B <sub>V</sub> DSS	Drain-to-Source Breakdown Voltage	200	—	—	V	V <sub>GS</sub> = 0V, I <sub>D</sub> = 1.0mA
ΔB <sub>V</sub> DSS/ΔT <sub>J</sub>	Temperature Coefficient of Breakdown Voltage	—	0.19	—	V/°C	Reference to 25°C, I <sub>D</sub> = 1.0mA
R <sub>DS(on)</sub>	Static Drain-to-Source On-State Resistance	—	—	0.13	Ω	V <sub>GS</sub> = 12V, I <sub>D</sub> = 10A ④
V <sub>GS(th)</sub>	Gate Threshold Voltage	2.0	—	4.0	V	V <sub>DS</sub> = V <sub>GS</sub> , I <sub>D</sub> = 1.0mA
ΔV <sub>GS(th)</sub> /ΔT <sub>J</sub>	Gate Threshold Voltage Coefficient	—	-9.76	—	mV/°C	
g <sub>fs</sub>	Forward Transconductance	11	—	—	S	V <sub>DS</sub> = 10V, I <sub>DS</sub> = 10A ④
I <sub>DSS</sub>	Zero Gate Voltage Drain Current	—	—	10	μA	V <sub>DS</sub> = 160V, V <sub>GS</sub> = 0V
		—	—	25		V <sub>DS</sub> = 160V, V <sub>GS</sub> = 0V, T <sub>J</sub> = 125°C
I <sub>GSS</sub>	Gate-to-Source Leakage Forward	—	—	100	nA	V <sub>GS</sub> = 20V
I <sub>GSS</sub>	Gate-to-Source Leakage Reverse	—	—	-100	nA	V <sub>GS</sub> = -20V
Q <sub>g</sub>	Total Gate Charge	—	—	42	nC	V <sub>GS</sub> = 12V, I <sub>D</sub> = 16A V <sub>DS</sub> = 100V
Q <sub>gs</sub>	Gate-to-Source Charge	—	—	10		
Q <sub>gd</sub>	Gate-to-Drain ('Miller') Charge	—	—	20		
t <sub>d(on)</sub>	Turn-On Delay Time	—	—	15	ns	V <sub>DD</sub> = 100V, I <sub>D</sub> = 16A, V <sub>GS</sub> = 12V, R <sub>G</sub> = 7.5Ω
t <sub>r</sub>	Rise Time	—	—	40		
t <sub>d(off)</sub>	Turn-Off Delay Time	—	—	35		
t <sub>f</sub>	Fall Time	—	—	15		
L <sub>S</sub> + L <sub>D</sub>	Total Inductance	—	6.8	—	nH	Measured from Drain lead ( 6mm / 0.025 in from package ) to Source lead ( 6mm/ 0.025 in from package )
C <sub>iss</sub>	Input Capacitance	—	1660	—	pF	V <sub>GS</sub> = 0V, V <sub>DS</sub> = 25V f = 1.0MHz
C <sub>oss</sub>	Output Capacitance	—	206	—		
C <sub>rss</sub>	Reverse Transfer Capacitance	—	2.6	—		
R <sub>g</sub>	Gate Resistance	—	1.75	—	Ω	f = 1.0MHz, open drain

**Source-Drain Diode Ratings and Characteristics**

	Parameter	Min	Typ	Max	Units	Test Conditions
I <sub>S</sub>	Continuous Source Current (Body Diode)	—	—	16	A	T <sub>j</sub> = 25°C, I <sub>S</sub> = 16A, V <sub>GS</sub> = 0V ④
I <sub>SM</sub>	Pulse Source Current (Body Diode) ①	—	—	64		
V <sub>SD</sub>	Diode Forward Voltage	—	—	1.2	V	T <sub>j</sub> = 25°C, I <sub>F</sub> = 16A, di/dt ≤ 100A/μs
t <sub>rr</sub>	Reverse Recovery Time	—	—	300	ns	V <sub>DD</sub> ≤ 25V ④
Q <sub>RR</sub>	Reverse Recovery Charge	—	—	3.2	μC	
t <sub>on</sub>	Forward Turn-On Time	Intrinsic turn-on time is negligible. Turn-on speed is substantially controlled by L <sub>S</sub> + L <sub>D</sub> .				

**Thermal Resistance**

	Parameter	Min	Typ	Max	Units	Test Conditions
R <sub>thJC</sub>	Junction-to-Case	—	—	1.67	°C/W	Typical Socket Mount
R <sub>thJA</sub>	Junction-to-Ambient	—	—	80		

Note: Corresponding Spice and Saber models are available on International Rectifier Web site.

For footnotes refer to the last page

## Radiation Characteristics

## IRHYS67230CM, 2N7592T3

International Rectifier Radiation Hardened MOSFETs are tested to verify their radiation hardness capability. The hardness assurance program at International Rectifier is comprised of two radiation environments. Every manufacturing lot is tested for total ionizing dose (per notes 5 and 6) using the TO-3 package. Both pre- and post-irradiation performance are tested and specified using the same drive circuitry and test conditions in order to provide a direct comparison.

**Table 1. Electrical Characteristics @ Tj = 25°C, Post Total Dose Irradiation** ⑤⑥

	Parameter	Up to 300K Rads (Si) <sup>1</sup>		Units	Test Conditions
		Min	Max		
BV <sub>DSS</sub>	Drain-to-Source Breakdown Voltage	200	—	V	V <sub>GS</sub> = 0V, I <sub>D</sub> = 1.0mA
V <sub>GS(th)</sub>	Gate Threshold Voltage	2.0	4.0		V <sub>GS</sub> = V <sub>DS</sub> , I <sub>D</sub> = 1.0mA
I <sub>GSS</sub>	Gate-to-Source Leakage Forward	—	100	nA	V <sub>GS</sub> = 20V
I <sub>GSS</sub>	Gate-to-Source Leakage Reverse	—	-100		V <sub>GS</sub> = -20V
I <sub>DSS</sub>	Zero Gate Voltage Drain Current	—	10	μA	V <sub>DS</sub> =160V, V <sub>GS</sub> =0V
R <sub>DS(on)</sub>	Static Drain-to-Source On-State Resistance (TO-3) ④	—	0.134	Ω	V <sub>GS</sub> = 12V, I <sub>D</sub> = 10A
R <sub>DS(on)</sub>	Static Drain-to-Source On-State Resistance (Low Ohmic TO-257) ④	—	0.13	Ω	V <sub>GS</sub> = 12V, I <sub>D</sub> = 10A
V <sub>SD</sub>	Diode Forward Voltage ④	—	1.2	V	V <sub>GS</sub> = 0V, I <sub>D</sub> = 16A

1. Part numbers IRHYS67230CM and IRHYS63230CM

International Rectifier radiation hardened MOSFETs have been characterized in heavy ion environment for Single Event Effects (SEE). Single Event Effects characterization is illustrated in Fig. a and Table 2.

**Table 2. Typical Single Event Effect Safe Operating Area**

LET (MeV/(mg/cm <sup>2</sup> ))	Energy (MeV)	Range (μm)	V <sub>DS</sub> (V)			
			@V <sub>GS</sub> = 0V	@V <sub>GS</sub> = -5V	@V <sub>GS</sub> = -10V	@V <sub>GS</sub> = -15V
42 ± 5%	2450 ± 5%	205 ± 5%	200	200	200	190
61 ± 5%	825 ± 5%	66 ± 5%	200	200	200	190
90 ± 5%	1470 ± 5%	80 ± 5%	170	170	-	-

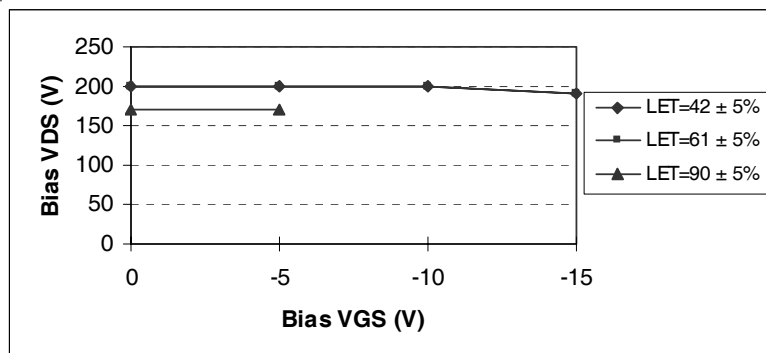

**Fig a. Typical Single Event Effect, Safe Operating Area**

For footnotes refer to the last page

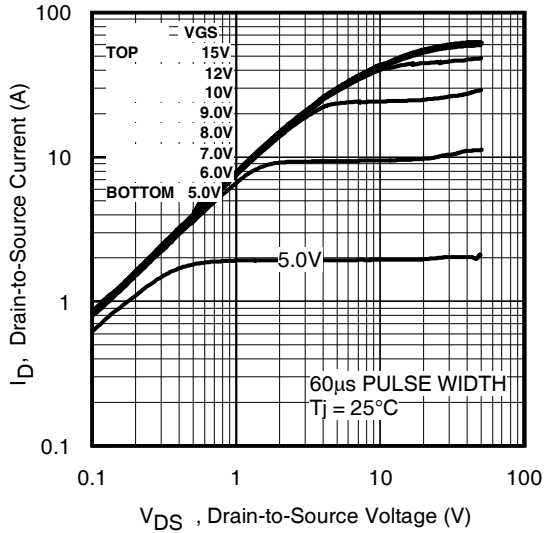

Fig 1. Typical Output Characteristics

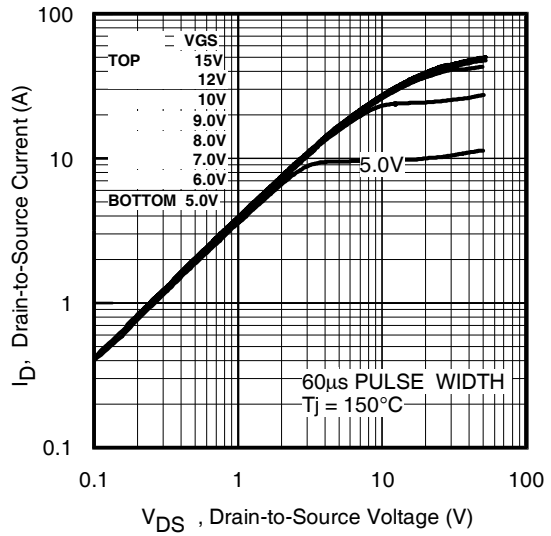

Fig 2. Typical Output Characteristics

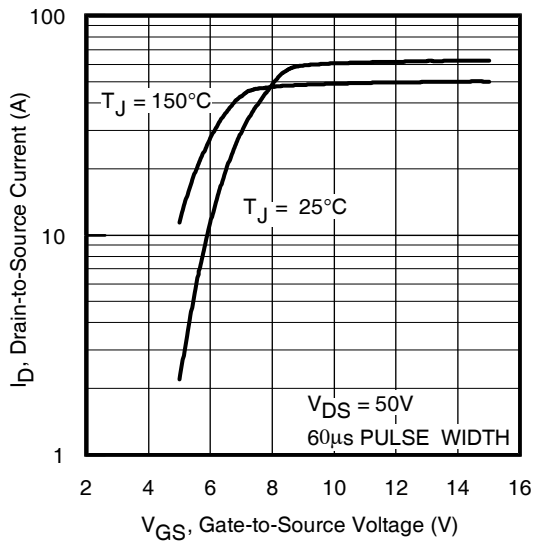

Fig 3. Typical Transfer Characteristics

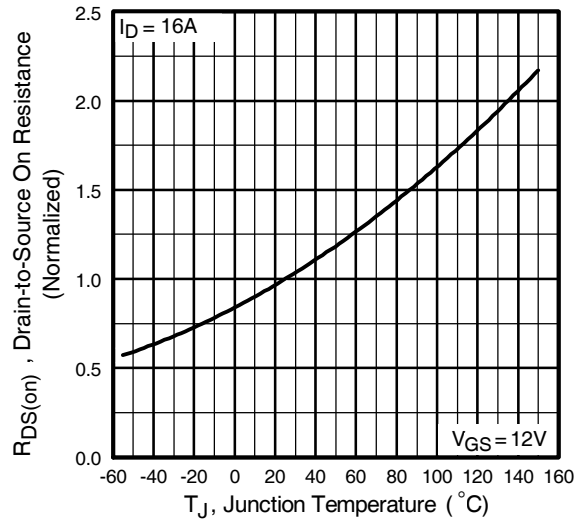

Fig 4. Normalized On-Resistance Vs. Temperature

Pre-Irradiation

IRHYS67230CM, 2N7592T3

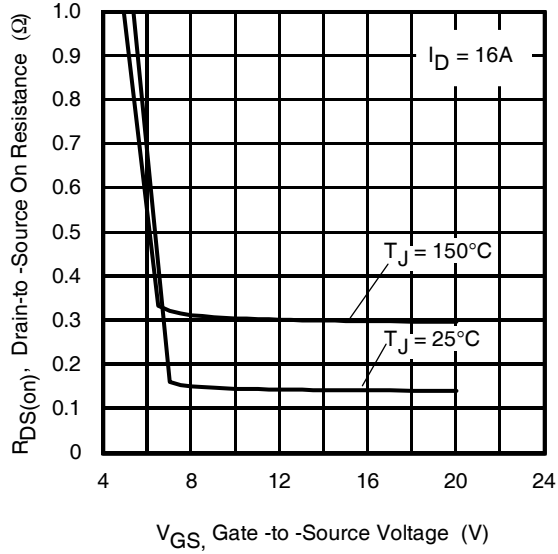

Fig 5. Typical On-Resistance Vs Gate Voltage

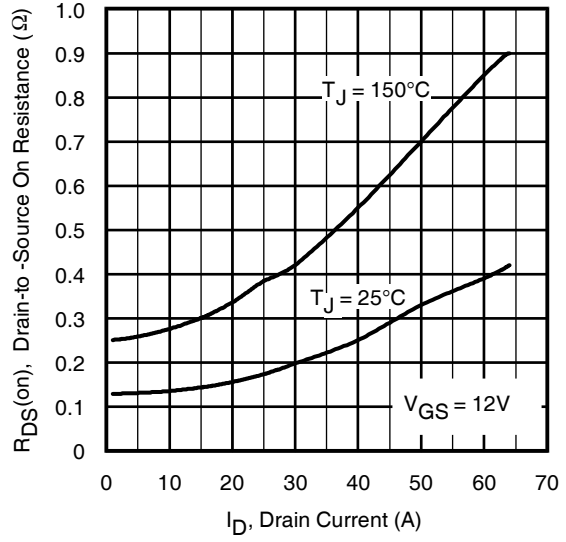

Fig 6. Typical On-Resistance Vs Drain Current

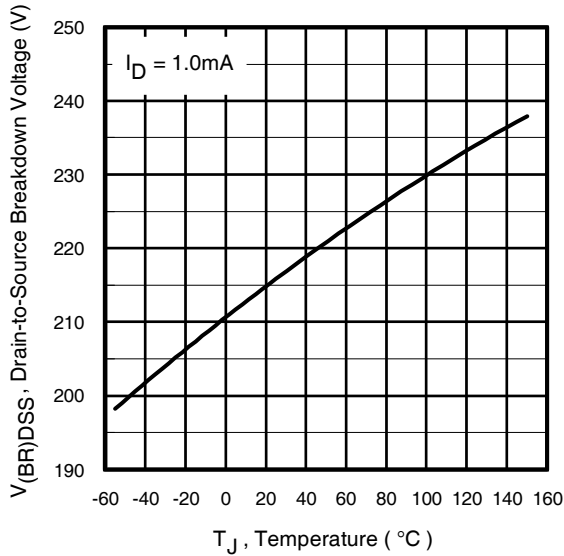

Fig 7. Typical Drain-to-Source Breakdown Voltage Vs Temperature

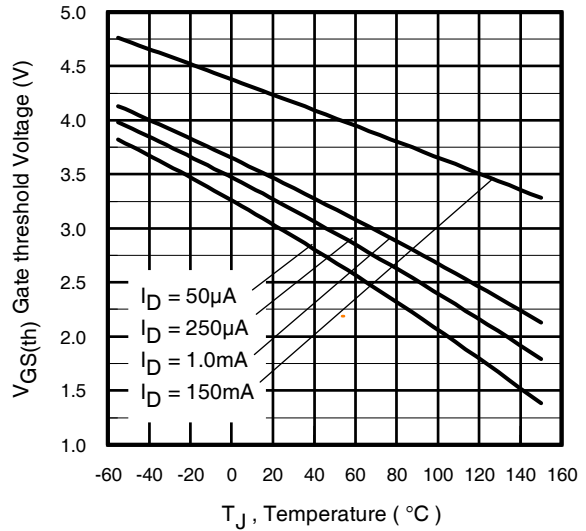
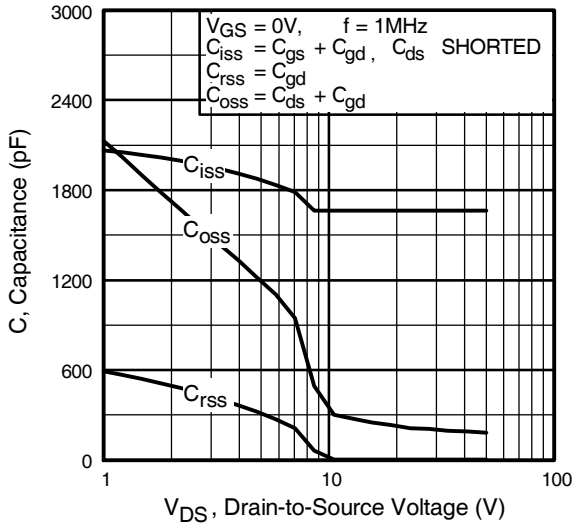
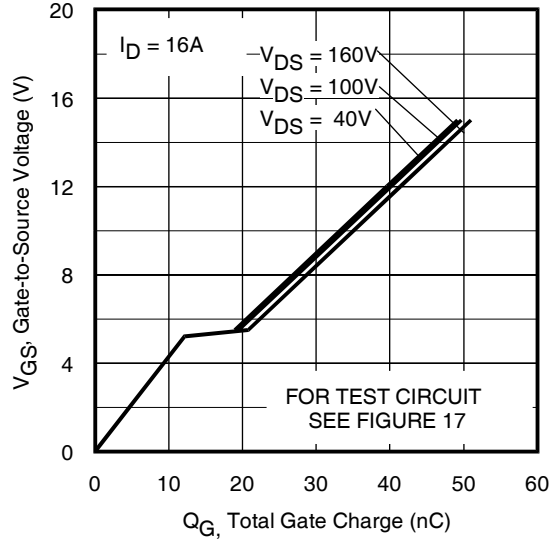

Fig 8. Typical Threshold Voltage Vs Temperature



**Fig 9.** Typical Capacitance Vs. Drain-to-Source Voltage



**Fig 10.** Typical Gate Charge Vs. Gate-to-Source Voltage

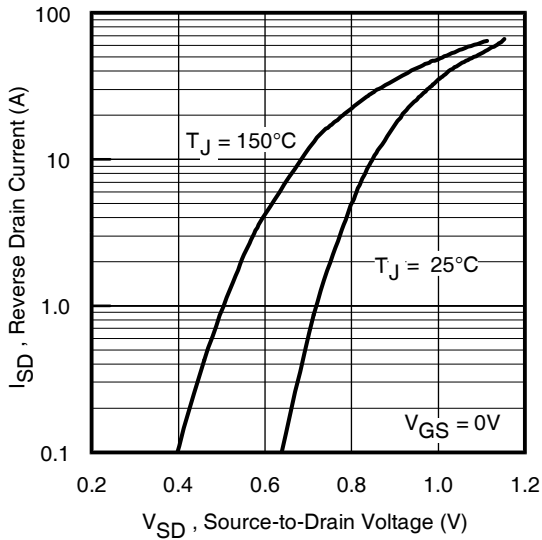

**Fig 11.** Typical Source-Drain Diode Forward Voltage

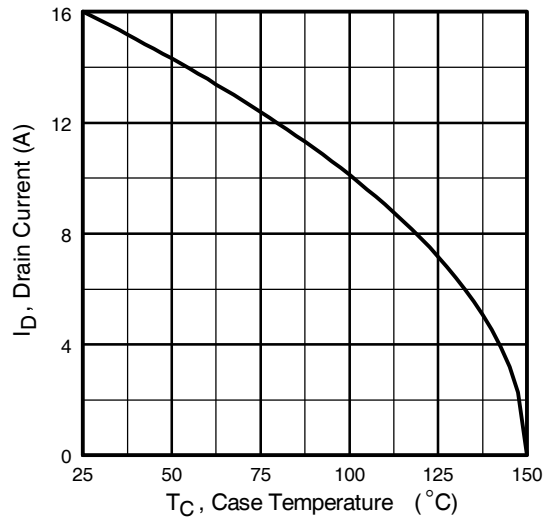

**Fig 12.** Maximum Drain Current Vs. Case Temperature

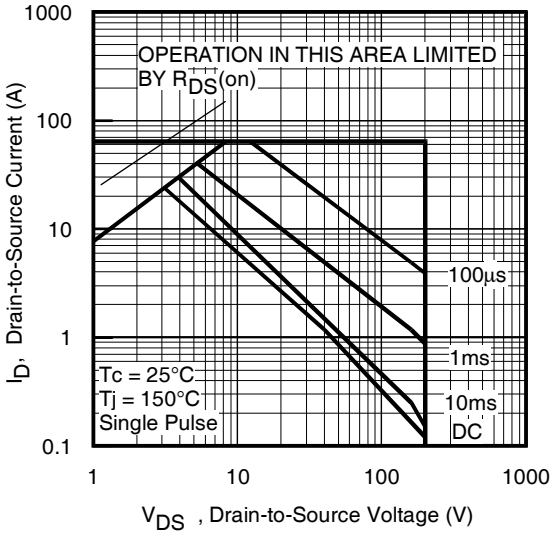

Fig 13. Maximum Safe Operating Area

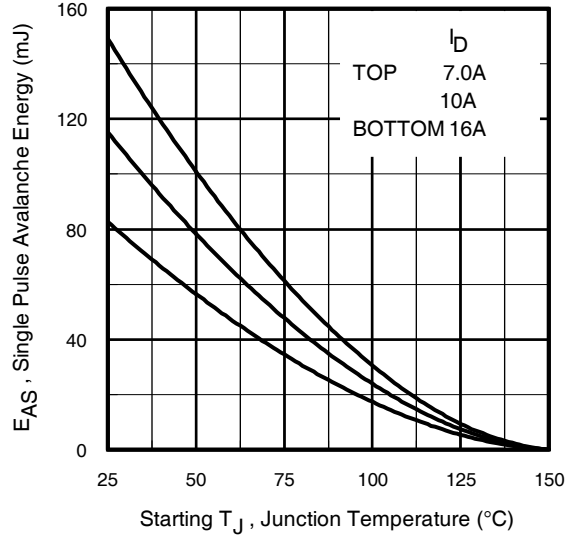

Fig 14. Maximum Avalanche Energy Vs. Drain Current

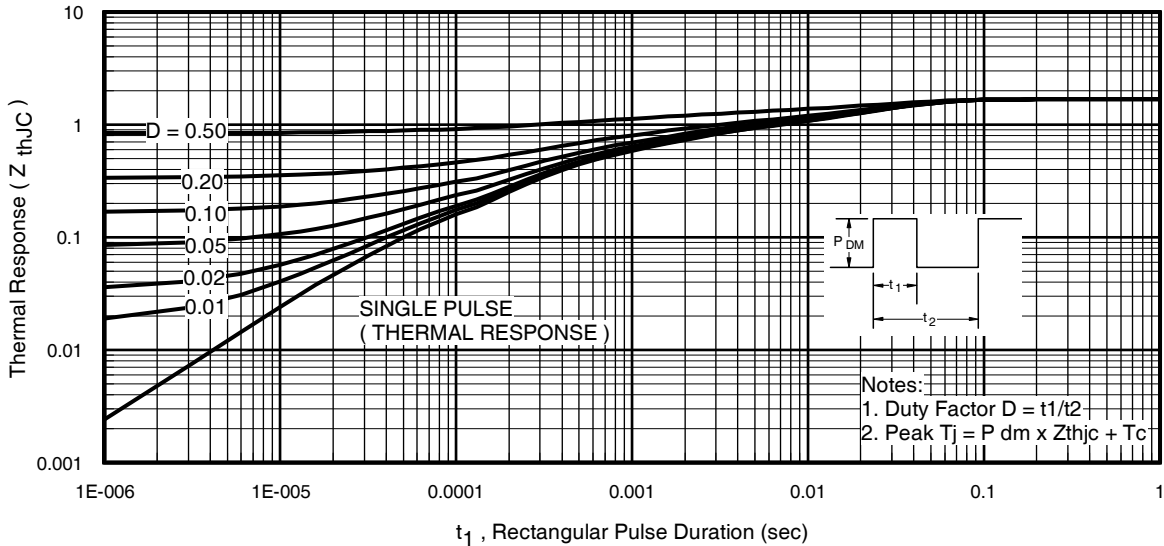

Fig 15. Maximum Effective Transient Thermal Impedance, Junction-to-Case

IRHYS67230CM, 2N7592T3

Pre-Irradiation

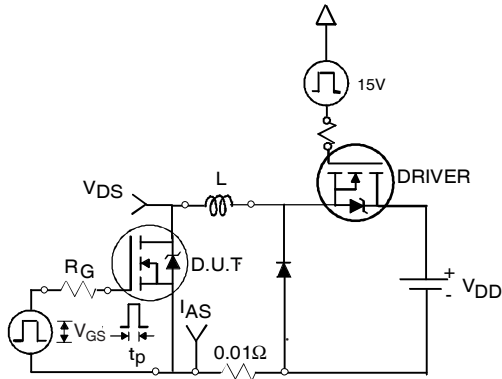

Fig 16a. Unclamped Inductive Test Circuit

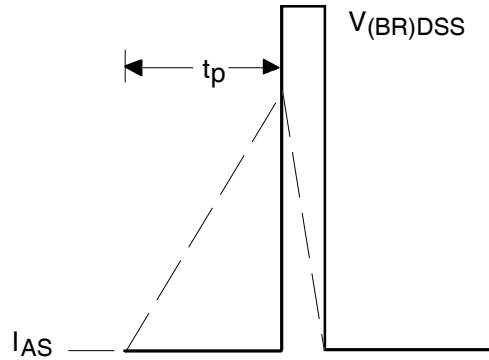

Fig 16b. Unclamped Inductive Waveforms

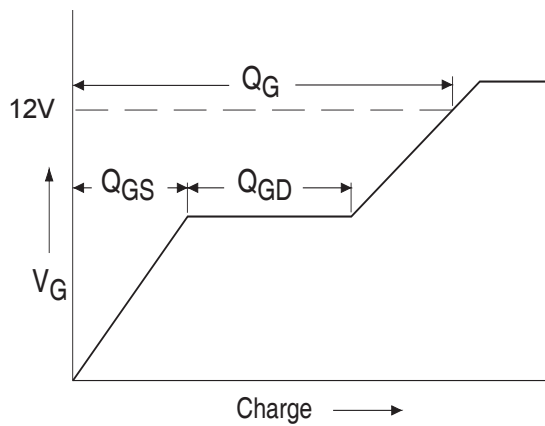

Fig 17a. Basic Gate Charge Waveform

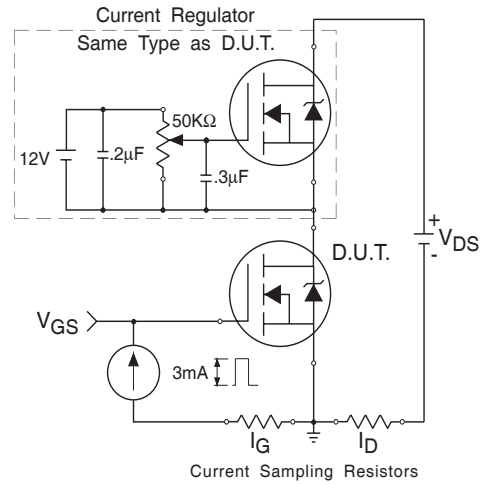

Fig 17b. Gate Charge Test Circuit

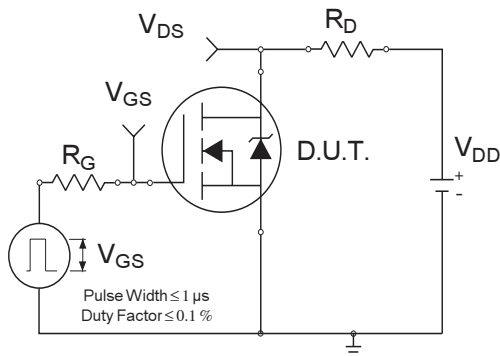

Fig 18a. Switching Time Test Circuit

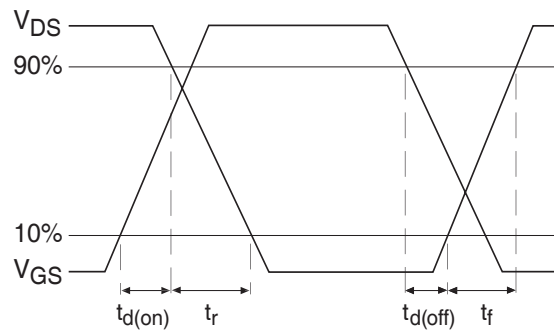

Fig 18b. Switching Time Waveforms



## Pre-Irradiation

IRHYS67230CM, 2N7592T3

### Footnotes:

- ① Repetitive Rating; Pulse width limited by maximum junction temperature.
- ②  $V_{DD} = 25V$ , starting  $T_J = 25^\circ C$ ,  $L = 0.65mH$   
Peak  $I_L = 16A$ ,  $V_{GS} = 12V$
- ③  $I_{SD} \leq 16A$ ,  $di/dt \leq 750A/\mu s$ ,  
 $V_{DD} \leq 200V$ ,  $T_J \leq 150^\circ C$
- ④ Pulse width  $\leq 300 \mu s$ ; Duty Cycle  $\leq 2\%$
- ⑤ **Total Dose Irradiation with  $V_{GS}$  Bias.**  
12 volt  $V_{GS}$  applied and  $V_{DS} = 0$  during irradiation per MIL-STD-750, method 1019, condition A.
- ⑥ **Total Dose Irradiation with  $V_{DS}$  Bias.**  
160 volt  $V_{DS}$  applied and  $V_{GS} = 0$  during irradiation per MIL-STD-750, method 1019, condition A.

## Case Outline and Dimensions — Low-Ohmic TO-257AA (Low Ohmic)

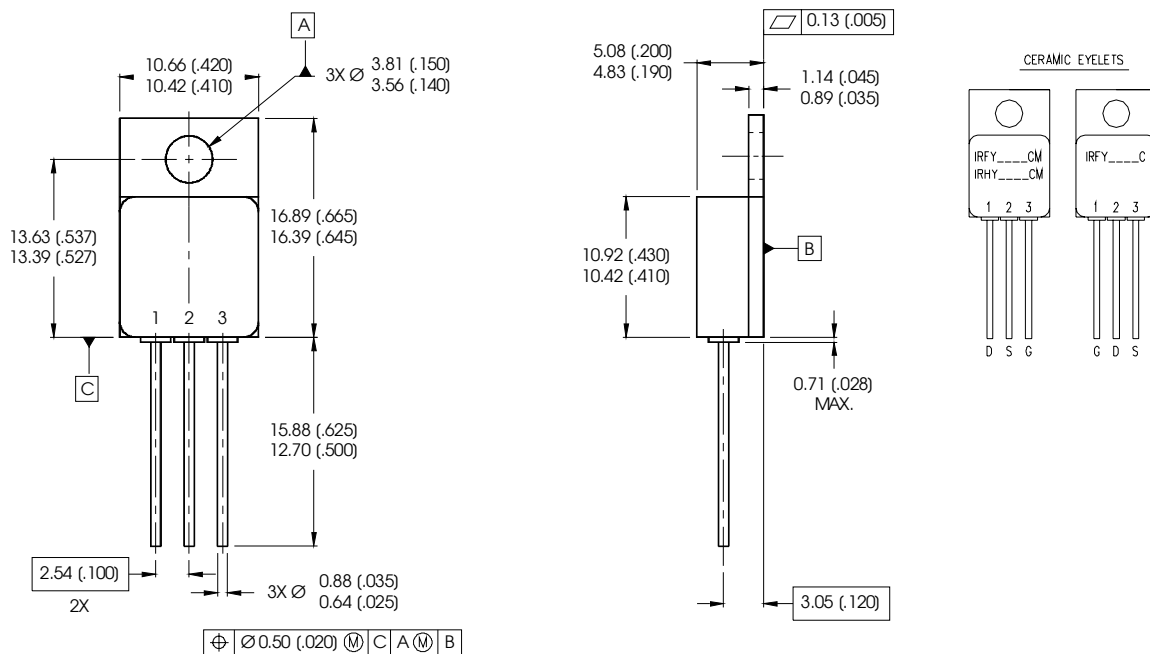

### NOTES:

1. DIMENSIONING & TOLERANCING PER ANSI Y14.5M-1994.
2. CONTROLLING DIMENSION: INCH.
3. DIMENSIONS ARE SHOWN IN MILLIMETERS (INCHES).
4. OUTLINE CONFORMS TO JEDEC OUTLINE TO-257AA.

### LEAD ASSIGNMENTS

- 1 = DRAIN
- 2 = SOURCE
- 3 = GATE

International  
**IR** Rectifier

IR WORLD HEADQUARTERS: 233 Kansas St., El Segundo, California 90245, USA Tel: (310) 252-7105

IR LEOMINSTER : 205 Crawford St., Leominster, Massachusetts 01453, USA Tel: (978) 534-5776

TAC Fax: (310) 252-7903

Visit us at [www.irf.com](http://www.irf.com) for sales contact information.

Data and specifications subject to change without notice. 06/2010