



# 2SA1015

## PNP SILICON TRANSISTOR

### LOW FREQUENCY PNP AMPLIFIER TRANSISTOR

#### FEATURES

- \* Collector-Emitter Voltage:  $BV_{CE0}=-50V$
- \* Collector Current up to 150mA
- \* High  $h_{FE}$  Linearity
- \* Complement to UTC 2SC1815

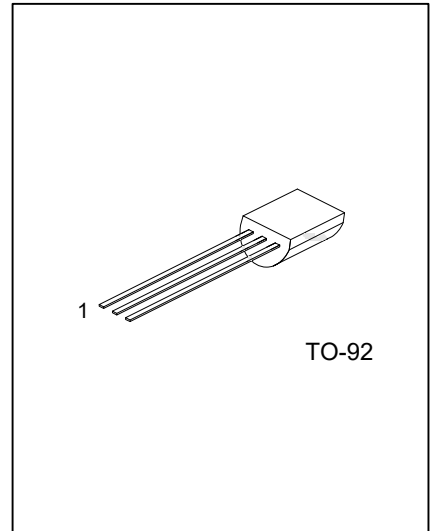

#### ORDERING INFORMATION

Ordering Number		Package	Pin Assignment			Packing
Lead Free Plating	Halogen Free		1	2	3	
2SA1015L-xx-T92-B	2SA1015G-xx-T92-B	TO-92	E	C	B	Tape Box
2SA1015L-xx-T92-K	2SA1015G-xx-T92-K	TO-92	E	C	B	Bulk

Note: Pin Assignment: E: Emitter    C: Collector    B: Base

<p>2SA1015G-xx-T92-B</p> <p>(1)Packing Type (2)Package Type (3)Rank (4)Green Package</p>	<p>(1) B: Tape Box, K: Bulk (2) T92: TO-92 (3) xx: refer to Classification of <math>h_{FE}</math> (4) G: Halogen Free and Lead Free, L: Lead Free</p>
--	---

#### MARKING

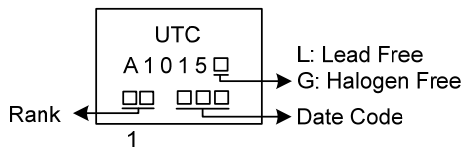

■ ABSOLUTE MAXIMUM RATING (T<sub>A</sub>=25°C, unless otherwise specified)

PARAMETER	SYMBOL	RATINGS	UNIT
Collector-Base Voltage	V <sub>CB0</sub>	-50	V
Collector-Emitter Voltage	V <sub>CEO</sub>	-50	V
Emitter-Base Voltage	V <sub>EBO</sub>	-5	V
Collector Current	I <sub>C</sub>	-150	mA
Base Current	I <sub>B</sub>	-50	mA
Collector Power Dissipation	P <sub>C</sub>	400	mW
Junction Temperature	T <sub>J</sub>	125	°C
Storage Temperature	T <sub>STG</sub>	-55 ~ +125	°C

Note: Absolute maximum ratings are those values beyond which the device could be permanently damaged.

Absolute maximum ratings are stress ratings only and functional device operation is not implied.

■ ELECTRICAL CHARACTERISTICS (T<sub>A</sub>=25°C, unless otherwise specified)

PARAMETER	SYMBOL	TEST CONDITIONS	MIN	TYP	MAX	UNIT
Collector-Base Breakdown Voltage	BV <sub>CB0</sub>	I <sub>C</sub> =-100μA, I <sub>E</sub> =0	-50			V
Collector-Emitter Breakdown Voltage	BV <sub>CEO</sub>	I <sub>C</sub> =-10mA, I <sub>B</sub> =0	-50			V
Emitter-Base Breakdown Voltage	BV <sub>EBO</sub>	I <sub>E</sub> =-10μA, I <sub>C</sub> =0	-5			V
Collector Cut-off Current	I <sub>CB0</sub>	V <sub>CB</sub> =-50V, I <sub>E</sub> =0			-100	nA
Emitter Cut-off Current	I <sub>EBO</sub>	V <sub>EB</sub> =-5V, I <sub>C</sub> =0			-100	nA
DC Current Gain	h <sub>FE1</sub>	V <sub>CE</sub> =-6V, I <sub>C</sub> =-2mA	120		700	
	h <sub>FE2</sub>	V <sub>CE</sub> =-6V, I <sub>C</sub> =-150mA	25			
Collector-Emitter Saturation Voltage	V <sub>CE(SAT)</sub>	I <sub>C</sub> =-100mA, I <sub>B</sub> =-10mA		-0.1	-0.3	V
Base-Emitter Saturation Voltage	V <sub>BE(SAT)</sub>	I <sub>C</sub> =-100mA, I <sub>B</sub> =-10mA			-1.1	V
Output Capacitance	C <sub>OB</sub>	V <sub>CB</sub> =-10V, I <sub>E</sub> =0, f=1MHz		4.0	7.0	pF
Current Gain Bandwidth Product	f <sub>T</sub>	V <sub>CE</sub> =-10V, I <sub>C</sub> =-1mA	80			MHz
Noise Figure	NF	V <sub>CE</sub> =-6V, I <sub>C</sub> =-0.1mA, R <sub>C</sub> =1kΩ, f=100Hz		0.5	6	dB

■ CLASSIFICATION OF h<sub>FE1</sub>

RANK	Y	GR	BL
RANGE	120-240	200-400	350-700

## TYPICAL CHARACTERISTICS

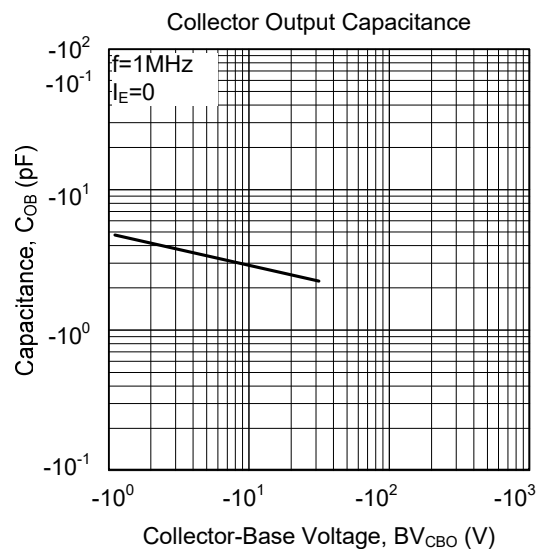
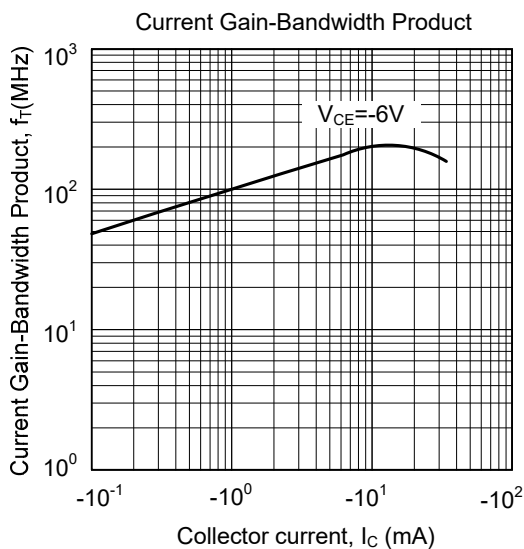
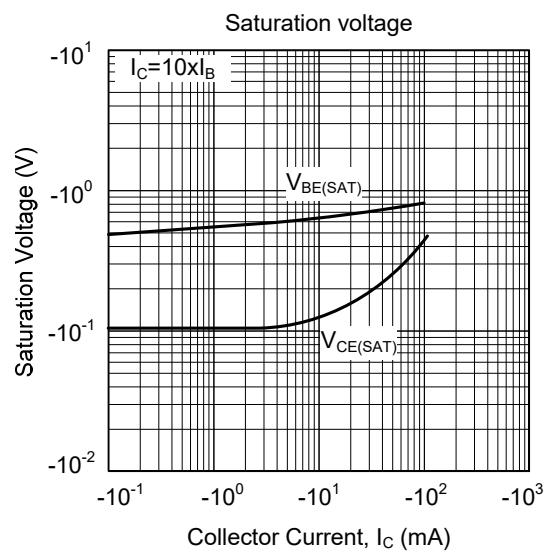
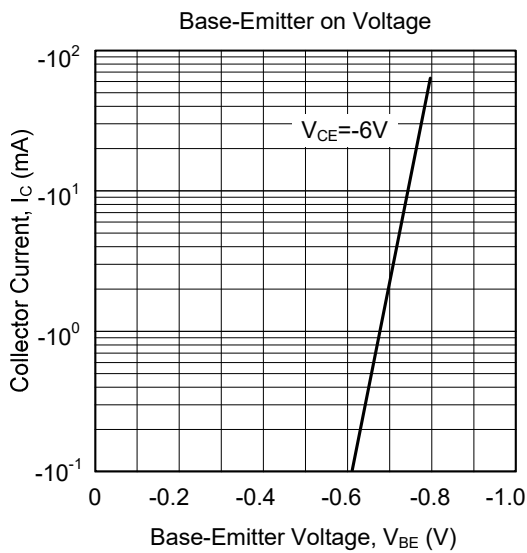
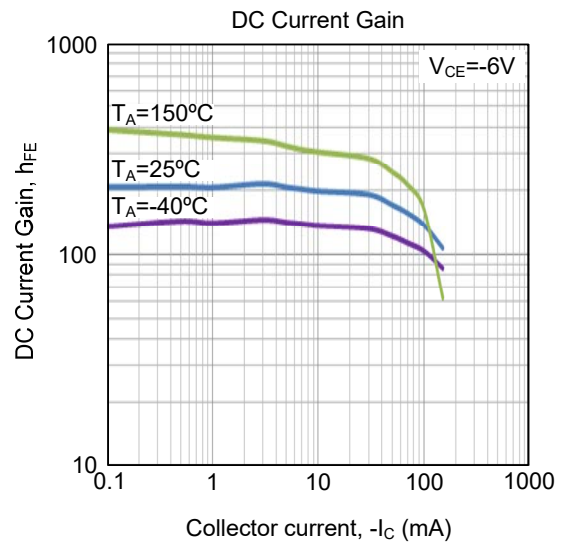
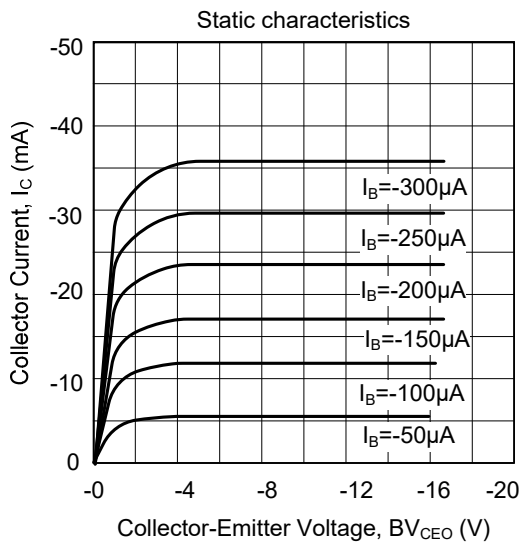

### ■ TYPICAL CHARACTERISTICS (Cont.)

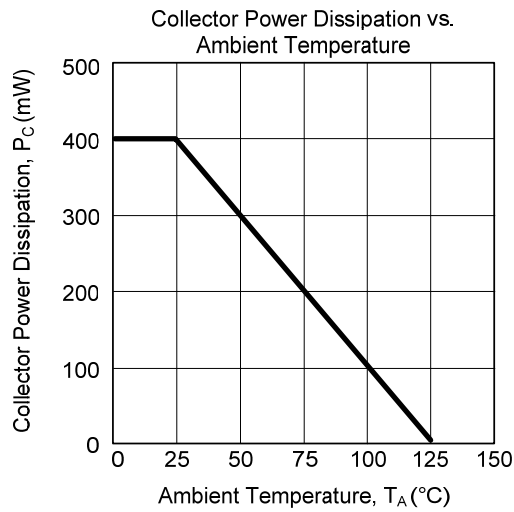

UTC assumes no responsibility for equipment failures that result from using products at values that exceed, even momentarily, rated values (such as maximum ratings, operating condition ranges, or other parameters) listed in products specifications of any and all UTC products described or contained herein. UTC products are not designed for use in life support appliances, devices or systems where malfunction of these products can be reasonably expected to result in personal injury. Reproduction in whole or in part is prohibited without the prior written consent of the copyright owner. UTC reserves the right to make changes to information published in this document, including without limitation specifications and product descriptions, at any time and without notice. This document supersedes and replaces all information supplied prior to the publication hereof.