

描述 / Descriptions

TO-251 塑封封装 PNP 半导体三极管。Silicon PNP transistor in a TO-251 Plastic Package.

特征 / Features

饱和压降低,开关时间短,与 2SC2655I 互补。

Low collector saturation voltage high speed switching time, complementary pair with 2SC2655I.

用途 / Applications

用于功率放大,电源开关。

Power amplifier and switching applications.

内部等效电路 / Equivalent Circuit

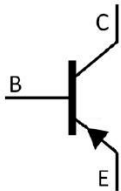

引脚排列 / Pinning

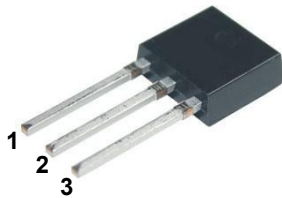

PIN1 : Base PIN 2 : Collector PIN 3 : Emitter

放大及印章代码 / h_{FE} Classifications & Marking

h_{FE} Classifications Symbol	O	Y
h_{FE} Range	70~140	120~240

极限参数 / Absolute Maximum Ratings(Ta=25°C)

参数 Parameter	符号 Symbol	数值 Rating	单位 Unit
Collector to Base Voltage	V_{CBO}	-50	V
Collector to Emitter Voltage	V_{CEO}	-50	V
Emitter to Base Voltage	V_{EBO}	-5.0	V
Collector Current - Continuous	I_C	-2.0	A
Collector Power Dissipation	P_C	900	mW
Junction Temperature	T_J	150	°C
Storage Temperature Range	T_{stg}	-55~150	°C

电性能参数 / Electrical Characteristics(Ta=25°C)

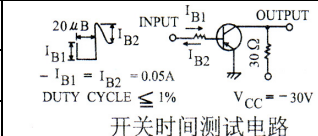
参数 Parameter	符号 Symbol	测试条件 Test Conditions	最小值 Min	典型值 Typ	最大值 Max	单位 Unit
Collector to Emitter Breakdown Voltage	V_{CEO}	$I_C = -10mA$ $I_B = 0$	-50			V
Collector Cut-Off Current	I_{CBO}	$V_{CB} = -50V$ $I_E = 0$			-1.0	μA
Emitter Cut-Off Current	I_{EBO}	$V_{EB} = -5.0V$ $I_C = 0$			-1.0	μA
DC Current Gain	$h_{FE(1)}$	$V_{CE} = -2.0V$ $I_C = -0.5A$	70		240	
	$h_{FE(2)}$	$V_{CE} = -2.0V$ $I_C = -1.5A$	40			
Collector to Emitter Saturation Voltage	$V_{CE(sat)}$	$I_C = -1.0A$ $I_B = -0.05A$			-0.5	V
Base to Emitter Saturation Voltage	$V_{BE(sat)}$	$I_C = -1.0A$ $I_B = -0.05A$			-1.2	V
Transition Frequency	f_T	$V_{CE} = -2.0V$ $I_C = -0.5A$	50	100		MHz
Collector output capacitance	C_{ob}	$V_{CB} = -10V$ $I_E = 0$ $f = 1.0MHz$			40	pF
Fall Time	t_f	 <p>204B INPUT OUTPUT I_{B1} I_{B2} I_C $V_{CC} = -30V$ $-I_{B1} = I_{B2} = 0.05A$ DUTY CYCLE $\leq 1\%$ 开关时间测试电路</p>		0.1		μs
Turn-On Time	t_{on}			0.1		μs
Storage Time	t_{stg}			1.0		μs

电参数曲线图 / Electrical Characteristic Curve

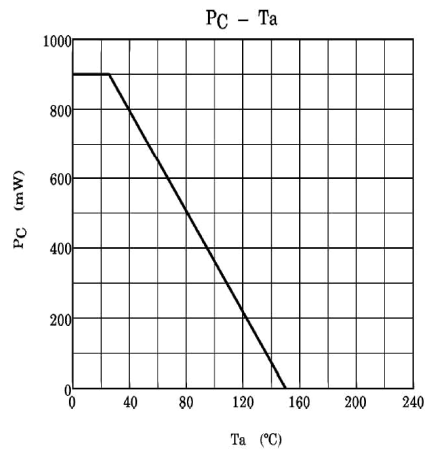
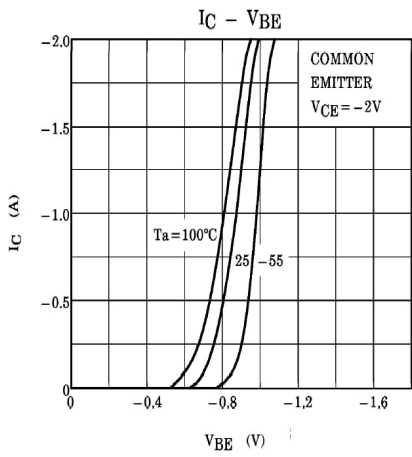
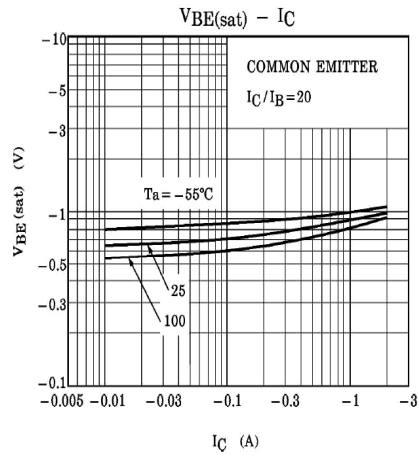
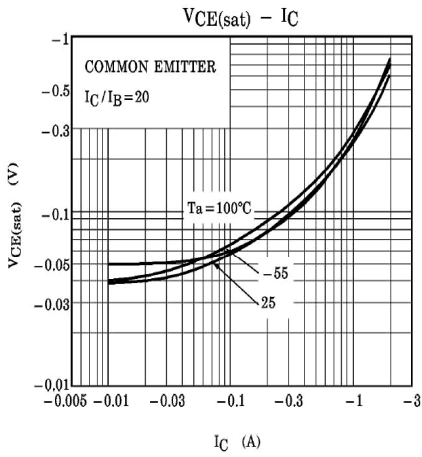
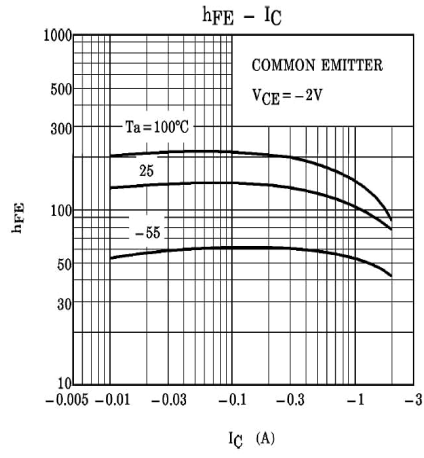
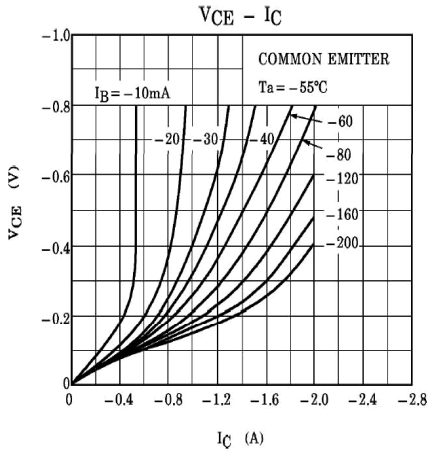

外形尺寸图 / Package Dimensions

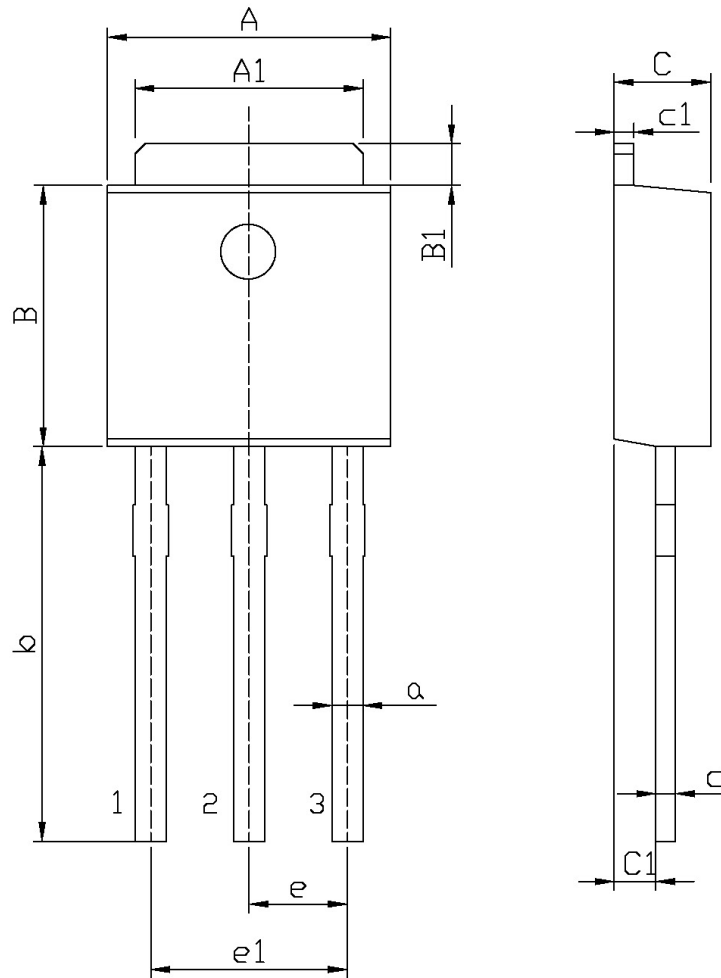

单位: mm

Symbol	Dimensions In Millimeters		Symbol	Dimensions In Millimeters	
	Min	Max		Min	Max
A	6.45	6.75	a	0.50	0.70
A1	5.10	5.50	b	9.00	9.40
B	5.95	6.25	c	0.45	0.55
B1	0.95	1.25	c1	0.45	0.55
C	2.20	2.40	e	2.24	2.34
C1	0.95	1.15	e1	4.43	4.73

TO-251

印章说明 / Marking Instructions

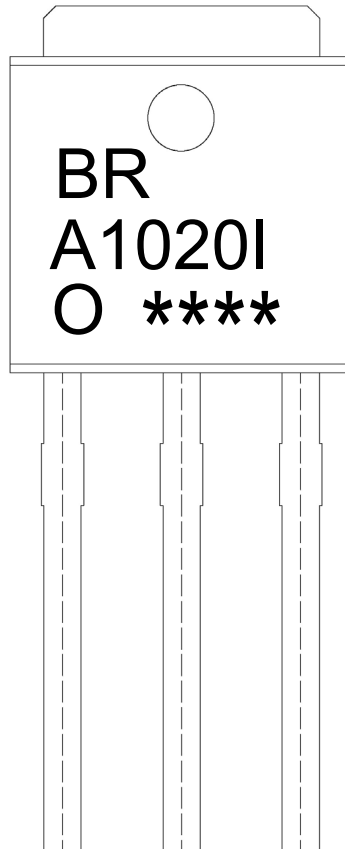

说明：

BR： 为公司代码

A1020I： 为型号代码

O： 为 h_{FE} 分档代码

****： 为生产批号代码，随生产批号变化。

Note:

BR: Company Code

A1020I: Product Type.

O: h_{FE} Classifications Symbol

****: Lot No. Code, code change with Lot No.

波峰焊温度曲线图(无铅) / Temperature Profile for Dip Soldering(Pb-Free)



说明：

- 1、预热温度 25 ~ 150°C，时间 60 ~ 90sec;
- 2、峰值温度 255±5°C，时间持续为 5±0.5sec;
- 3、焊接制程冷却速度为 2 ~ 10°C/sec.

Note:

- 1.Preheating:25~150°C, Time:60~90sec.
- 2.Peak Temp.:255±5°C, Duration:5±0.5sec.
3. Cooling Speed: 2~10°C/sec.

耐焊接热试验条件 / Resistance to Soldering Heat Test Conditions

温度：270±5°C

时间：10±1 sec.

Temp.:270±5°C

Time:10±1 sec

包装规格 / Packaging SPEC.

散件包装 / BULK

Package Type 封装形式	Units 包装数量					Dimension 包装尺寸 (unit: mm ³)		
	Units/Bag 只/袋	Bags/Inner Box 袋/盒	Units/Inner Box 只/盒	Inner Boxes/Outer Box 盒/箱	Units/Outer Box 只/箱	Bag 袋	Inner Box 盒	Outer Box 箱
TO-251	1,000	10	10,000	5	50,000	135×190	237×172×102	560×245×195

套管包装 / TUBE

Package Type 封装形式	Units 包装数量					Dimension 包装尺寸 (unit: mm ³)		
	Units/Tube 只/套管	Tubes/Inner Box 套管/盒	Units/Inner Box 只/盒	Inner Boxes/Outer Box 盒/箱	Units/Outer Box 只/箱	Tube 套管	Inner Box 盒	Outer Box 箱
TO-251/252	75	48	3,600	5	18,000	526×20.5×5.25	555×164×50	575×290×180

使用说明 / Notices