



1. BASE
2. EMITTER
3. COLLECTOR

Features

- ✧ Large I_C · $I_{CMax} = -500$ mA
- ✧ Low $V_{CE(sat)}$ · Ideal for low-voltage operation.

MARKING : HP, HQ, HR

MAXIMUM RATINGS ($T_A=25^\circ\text{C}$ unless otherwise noted)

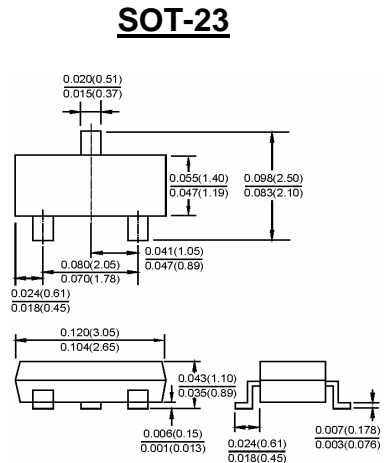

Dimensions in inches and (millimeters)

Symbol	Parameter	Value	Units
V_{CBO}	Collector-Base Voltage	-40	V
V_{CEO}	Collector-Emitter Voltage	-32	V
V_{EBO}	Emitter-Base Voltage	-5	V
I_C	Collector Current -Continuous	-500	mA
P_C	Collector Power Dissipation	200	mW
T_J	Junction Temperature	150	$^\circ\text{C}$
T_{stg}	Storage Temperature	-55-150	$^\circ\text{C}$

ELECTRICAL CHARACTERISTICS ($T_{amb}=25^\circ\text{C}$ unless otherwise specified)

Parameter	Symbol	Test conditions	MIN	TYP	MAX	UNIT
Collector-base breakdown voltage	$V_{(BR)CBO}$	$I_C = -100\mu\text{A}, I_E = 0$	-40			V
Collector-emitter breakdown voltage	$V_{(BR)CEO}$	$I_C = -1\text{mA}, I_B = 0$	-32			V
Emitter-base breakdown voltage	$V_{(BR)EBO}$	$I_E = -100\mu\text{A}, I_C = 0$	-5			V
Collector cut-off current	I_{CBO}	$V_{CB} = -20\text{V}, I_E = 0$			-1	μA
Emitter cut-off current	I_{EBO}	$V_{EB} = -4\text{V}, I_C = 0$			-1	μA
DC current gain	h_{FE}	$V_{CE} = -3\text{V}, I_C = -10\text{mA}$	82		390	
Collector-emitter saturation voltage	$V_{CE(sat)}$	$I_C = -100\text{mA}, I_B = -10\text{mA}$			-0.4	V
Transition frequency	f_T	$V_{CE} = -5\text{V}, I_C = -20\text{mA}, f = 100\text{MHz}$		200		MHz
Collector output capacitance	C_{ob}	$V_{CB} = -10\text{V}, I_E = 0, f = 1\text{MHz}$		7		pF

CLASSIFICATION OF h_{FE}

Rank	P	Q	R
Range	82 - 180	120 - 270	180 - 390

Typical Characteristics

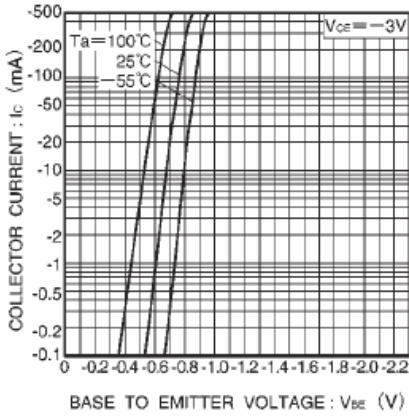

Fig.1 Grounded emitter propagation

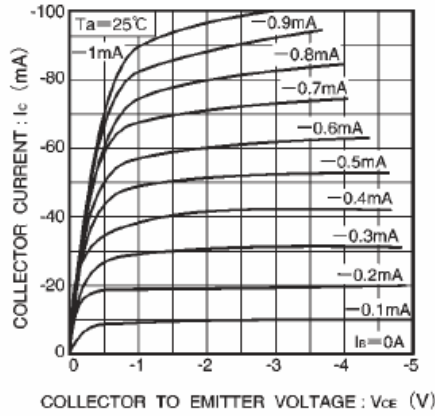

Fig.2 Grounded emitter output characteristics (I)

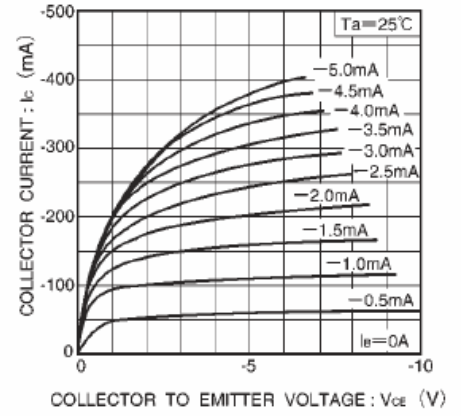

Fig.3 Grounded emitter output characteristics (II)

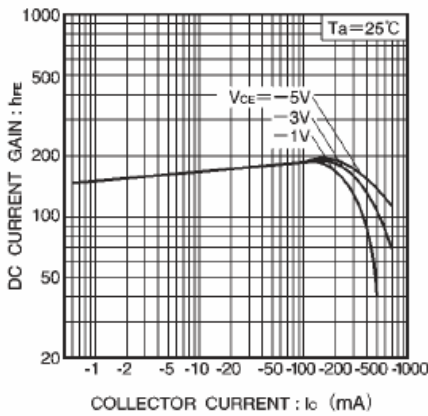

Fig.4 DC current gain vs. collector current (I)

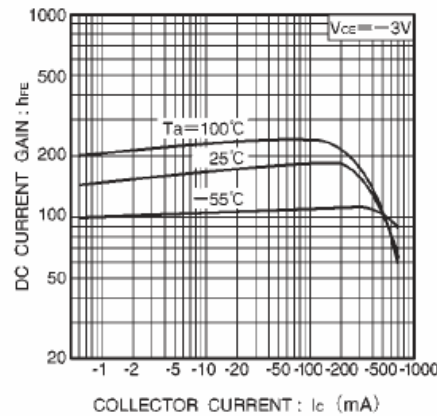

Fig.5 DC current gain vs. collector current (II)

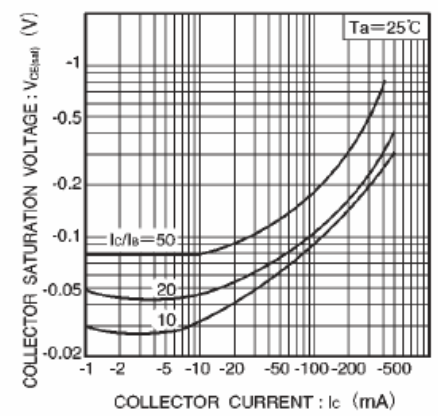

Fig.6 Collector-emitter saturation voltage vs. collector current (I)

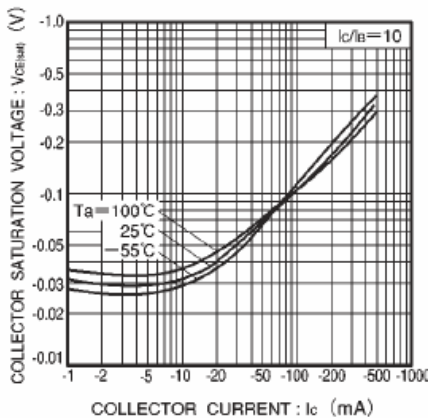

Fig.7 Collector-emitter saturation voltage vs. collector current (II)

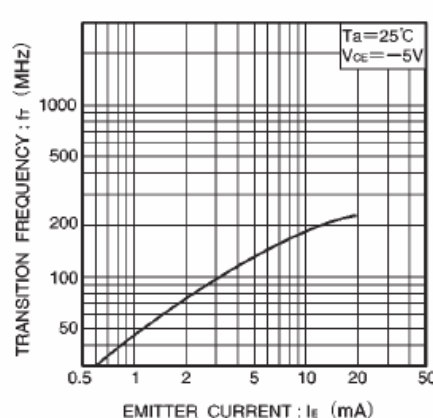

Fig.8 Gain bandwidth product vs. emitter current

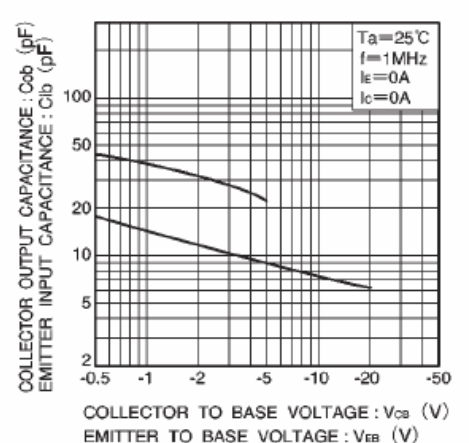

Fig.9 Collector output capacitance vs. collector-base voltage. Emitter input capacitance vs. emitter-base voltage