

# 2SA1193(K)

Silicon PNP Epitaxial, Darlington

REJ03G0641-0200  
 (Previous ADE-208-1013)  
 Rev.2.00  
 Aug.10.2005

## Application

High gain amplifier

## Outline

RENESAS Package code: PRSS0003DC-A  
 (Package name: TO-92 Mod)

1. Emitter  
 2. Collector  
 3. Base

## Absolute Maximum Ratings

(Ta = 25°C)

Item	Symbol	Ratings	Unit
Collector to base voltage	$V_{CBO}$	-60	V
Collector to emitter voltage	$V_{CEO}$	-60	V
Emitter to base voltage	$V_{EBO}$	-7	V
Collector current	$I_C$	-0.5	A
Collector peak current	$i_{C(peak)}$	-1.0	A
Collector power dissipation	$P_C$	0.9	W
Junction temperature	$T_j$	150	°C
Storage temperature	$T_{stg}$	-55 to +150	°C

## Electrical Characteristics

(Ta = 25°C)

Item	Symbol	Min	Typ	Max	Unit	Test conditions
Collector to emitter breakdown voltage	$V_{(BR)CEO}$	-60	—	—	V	$I_C = -1 \text{ mA}$ , $R_{BE} = \infty$
Collector cutoff current	$I_{CBO}$	—	—	-1.0	$\mu\text{A}$	$V_{CB} = -60 \text{ V}$ , $I_E = 0$
Emitter cutoff current	$I_{EBO}$	—	—	-1.0	$\mu\text{A}$	$V_{EB} = -7 \text{ V}$ , $I_C = 0$
DC current transfer ratio	$h_{FE}$	2000	—	—		$V_{CE} = -3 \text{ V}$ , $I_C = -250 \text{ mA}^{*1}$
Collector to emitter saturation voltage	$V_{CE(sat)}$	—	—	-1.5	V	$I_C = -250 \text{ mA}$ , $I_B = -0.5 \text{ mA}^{*1}$
Base to emitter saturation voltage	$V_{BE(sat)}$	—	—	-2.0	V	
Turn on time	$t_{on}$	—	0.3	—	$\mu\text{s}$	$I_C = -250 \text{ mA}$
Turn off time	$t_{off}$	—	0.9	—	$\mu\text{s}$	$I_{B1} = -I_{B2} = -0.5 \text{ mA}$

Note: 1. Pulse test

Not recommend  
for new design

Main Characteristics

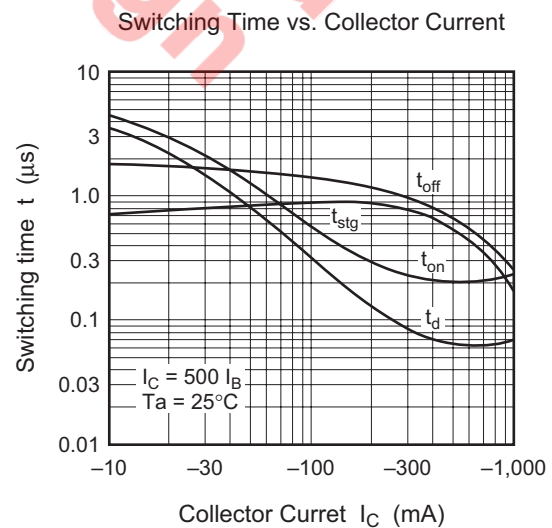
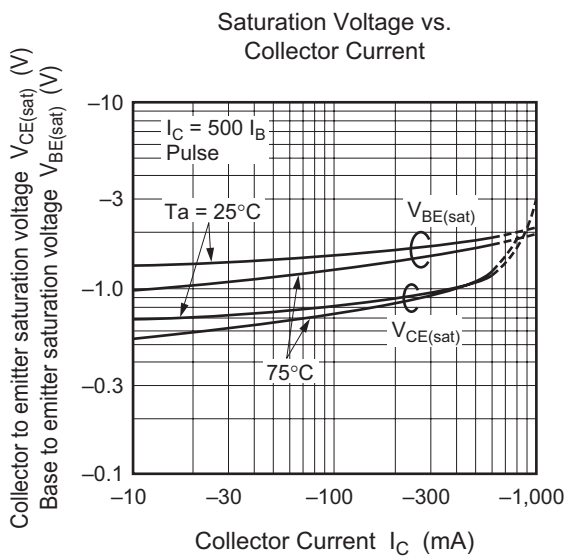
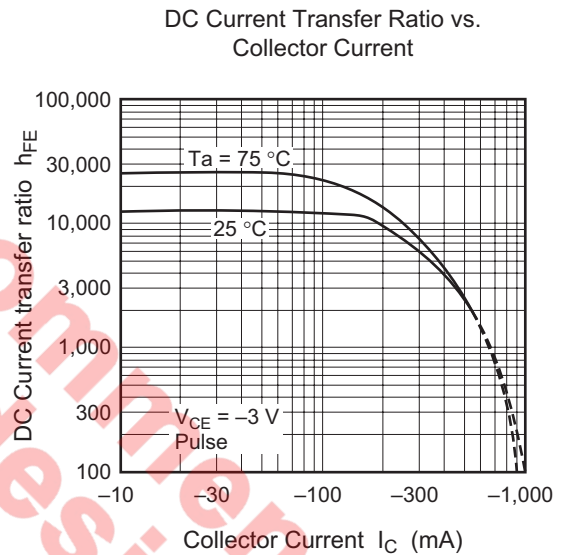
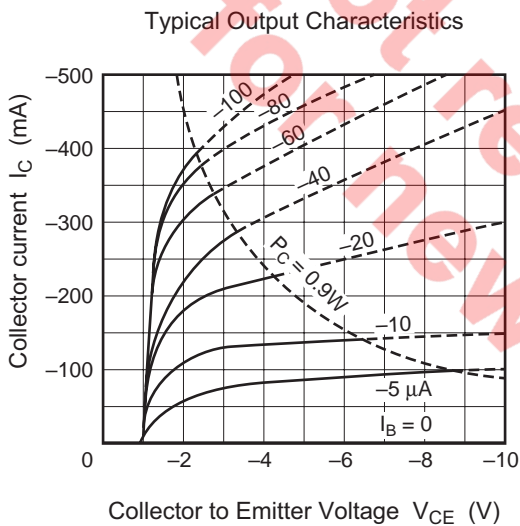
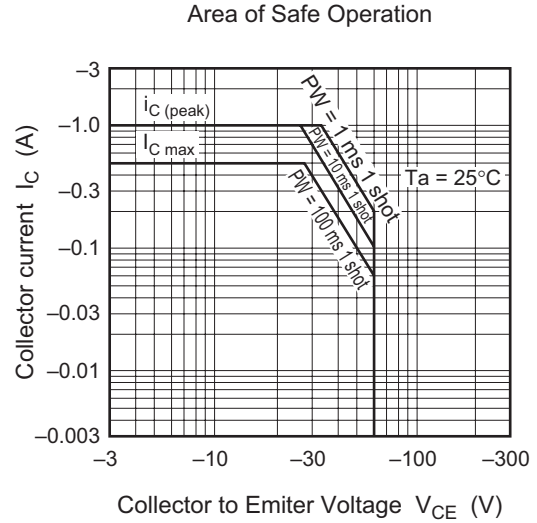
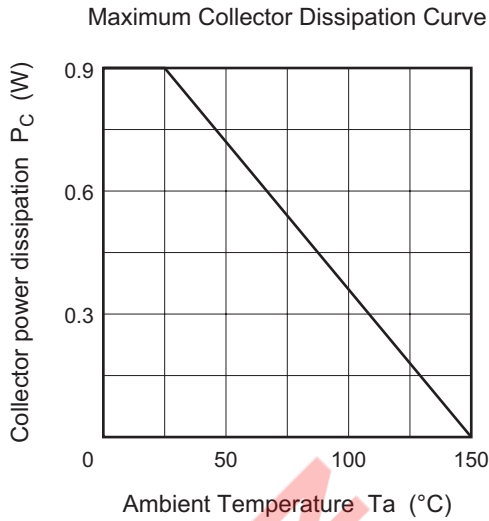

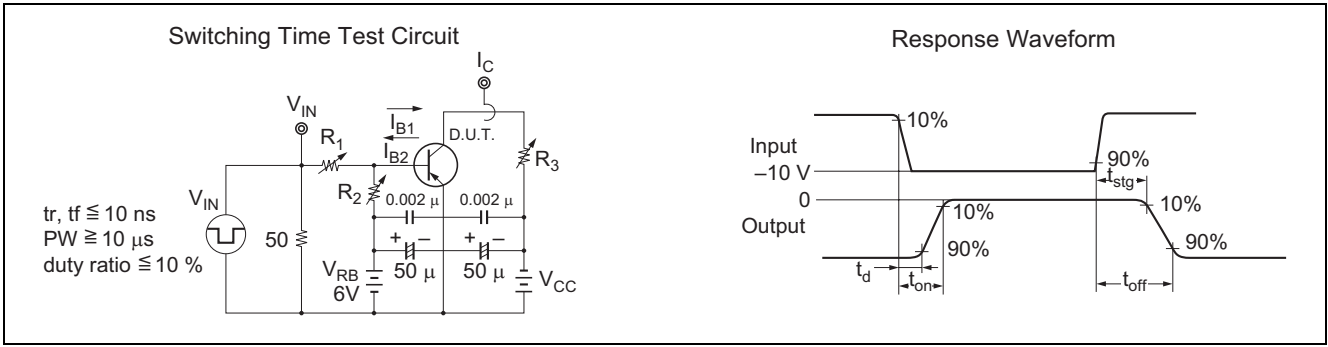

Not recommend  
for new design

## Package Dimensions

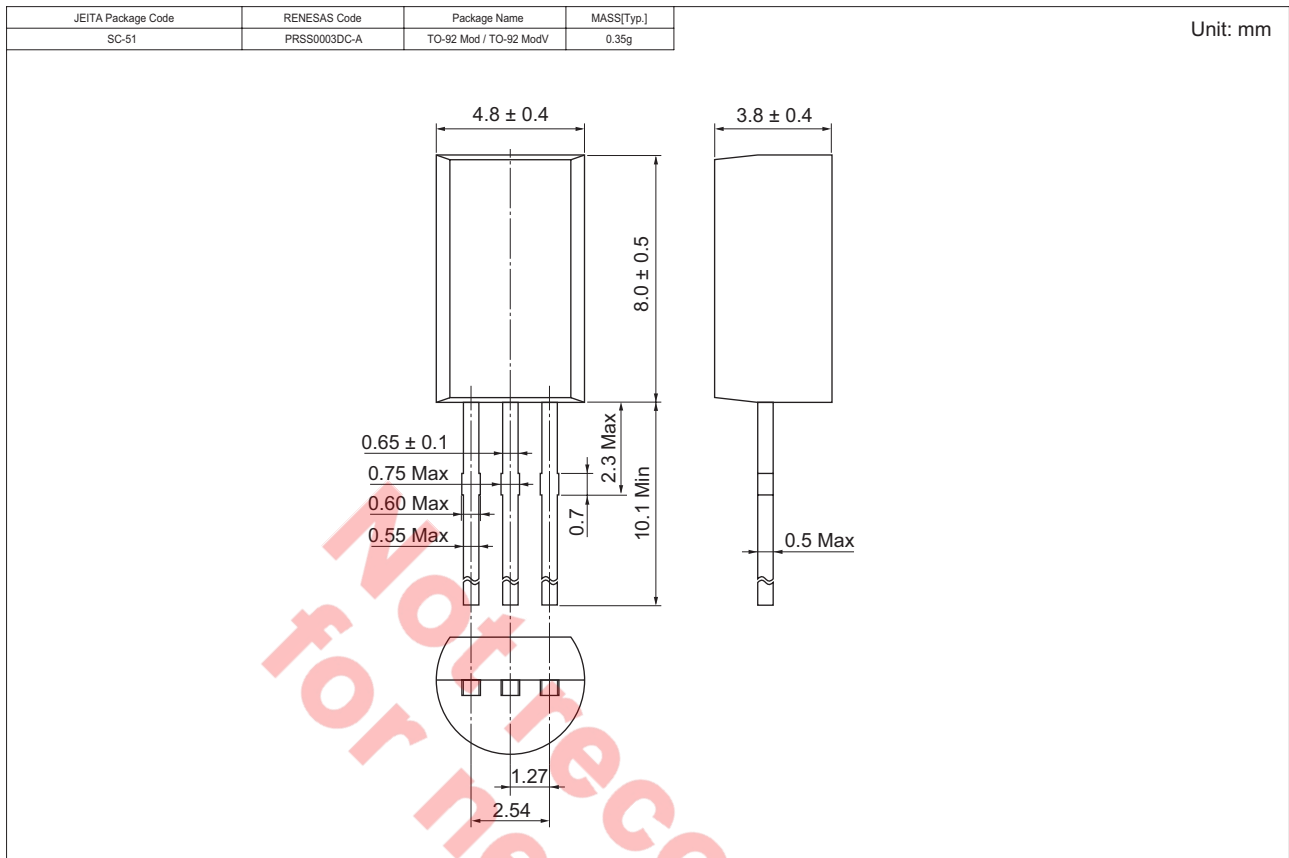

## Ordering Information

Part Name	Quantity	Shipping Container
2SA1193KTZ-E	2500	Hold Box, Radial Taping

Note: For some grades, production may be terminated. Please contact the Renesas sales office to check the state of production before ordering the product.

## Renesas Technology Corp. Sales Strategic Planning Div. Nippon Bldg., 2-6-2, Ohte-machi, Chiyoda-ku, Tokyo 100-0004, Japan

Keep safety first in your circuit designs!

1. Renesas Technology Corp. puts the maximum effort into making semiconductor products better and more reliable, but there is always the possibility that trouble may occur with them. Trouble with semiconductors may lead to personal injury, fire or property damage. Remember to give due consideration to safety when making your circuit designs, with appropriate measures such as (i) placement of substitutive, auxiliary circuits, (ii) use of nonflammable material or (iii) prevention against any malfunction or mishap.

Notes regarding these materials

1. These materials are intended as a reference to assist our customers in the selection of the Renesas Technology Corp. product best suited to the customer's application; they do not convey any license under any intellectual property rights, or any other rights, belonging to Renesas Technology Corp. or a third party.
2. Renesas Technology Corp. assumes no responsibility for any damage, or infringement of any third-party's rights, originating in the use of any product data, diagrams, charts, programs, algorithms, or circuit application examples contained in these materials.
3. All information contained in these materials, including product data, diagrams, charts, programs and algorithms represents information on products at the time of publication of these materials, and are subject to change by Renesas Technology Corp. without notice due to product improvements or other reasons. It is therefore recommended that customers contact Renesas Technology Corp. or an authorized Renesas Technology Corp. product distributor for the latest product information before purchasing a product listed herein.  
The information described here may contain technical inaccuracies or typographical errors.  
Renesas Technology Corp. assumes no responsibility for any damage, liability, or other loss rising from these inaccuracies or errors.  
Please also pay attention to information published by Renesas Technology Corp. by various means, including the Renesas Technology Corp. Semiconductor home page (<http://www.renesas.com>).
4. When using any or all of the information contained in these materials, including product data, diagrams, charts, programs, and algorithms, please be sure to evaluate all information as a total system before making a final decision on the applicability of the information and products. Renesas Technology Corp. assumes no responsibility for any damage, liability or other loss resulting from the information contained herein.
5. Renesas Technology Corp. semiconductors are not designed or manufactured for use in a device or system that is used under circumstances in which human life is potentially at stake. Please contact Renesas Technology Corp. or an authorized Renesas Technology Corp. product distributor when considering the use of a product contained herein for any specific purposes, such as apparatus or systems for transportation, vehicular, medical, aerospace, nuclear, or undersea repeater use.
6. The prior written approval of Renesas Technology Corp. is necessary to reprint or reproduce in whole or in part these materials.
7. If these products or technologies are subject to the Japanese export control restrictions, they must be exported under a license from the Japanese government and cannot be imported into a country other than the approved destination.  
Any diversion or reexport contrary to the export control laws and regulations of Japan and/or the country of destination is prohibited.
8. Please contact Renesas Technology Corp. for further details on these materials or the products contained therein.



### RENESAS SALES OFFICES

<http://www.renesas.com>

Refer to "<http://www.renesas.com/en/network>" for the latest and detailed information.

#### Renesas Technology America, Inc.

450 Holger Way, San Jose, CA 95134-1368, U.S.A  
Tel: <1> (408) 382-7500, Fax: <1> (408) 382-7501

#### Renesas Technology Europe Limited

Dukes Meadow, Millboard Road, Bourne End, Buckinghamshire, SL8 5FH, U.K.  
Tel: <44> (1628) 585-100, Fax: <44> (1628) 585-900

#### Renesas Technology Hong Kong Ltd.

7th Floor, North Tower, World Finance Centre, Harbour City, 1 Canton Road, Tsimshatsui, Kowloon, Hong Kong  
Tel: <852> 2265-6688, Fax: <852> 2730-6071

#### Renesas Technology Taiwan Co., Ltd.

10th Floor, No.99, Fushing North Road, Taipei, Taiwan  
Tel: <886> (2) 2715-2888, Fax: <886> (2) 2713-2999

#### Renesas Technology (Shanghai) Co., Ltd.

Unit2607 Ruijing Building, No.205 Maoming Road (S), Shanghai 200020, China  
Tel: <86> (21) 6472-1001, Fax: <86> (21) 6415-2952

#### Renesas Technology Singapore Pte. Ltd.

1 Harbour Front Avenue, #06-10, Keppel Bay Tower, Singapore 098632  
Tel: <65> 6213-0200, Fax: <65> 6278-8001

#### Renesas Technology Korea Co., Ltd.

Kukje Center Bldg. 18th Fl., 191, 2-ka, Hangang-ro, Yongsan-ku, Seoul 140-702, Korea  
Tel: <82> 2-796-3115, Fax: <82> 2-796-2145

#### Renesas Technology Malaysia Sdn. Bhd.

Unit 906, Block B, Menara Amcorp, Amcorp Trade Centre, No.18, Jalan Persiaran Barat, 46050 Petaling Jaya, Selangor Darul Ehsan, Malaysia  
Tel: <603> 7955-9390, Fax: <603> 7955-9510