

DESCRIPTION The 2SA1458 is designed for general purpose amplifier and high speed switching applications.

- FEATURES**
- High Frequency Current Gain.
 - High Speed Switching.
 - Small Output Capacitance.
 - Low Collector Saturation Voltage.
 - Complementary to the NEC 2SC3731 NPN transistor.

ABSOLUTE MAXIMUM RATINGS ($T_a = 25^\circ\text{C}$)

Maximum Temperatures	
Storage Temperature	-55 to +150 °C
Junction Temperature	150 °C Maximum
Maximum Power Dissipation ($T_a = 25^\circ\text{C}$)	
Total Power Dissipation	250 mW
Maximum Voltages and Current ($T_a = 25^\circ\text{C}$)	
V_{CBO} Collector to Base Voltage	-40 V
V_{CEO} Collector to Emitter Voltage	-40 V
V_{EBO} Emitter to Base Voltage	-5.0 V
I_C Collector Current (DC)	-200 mA

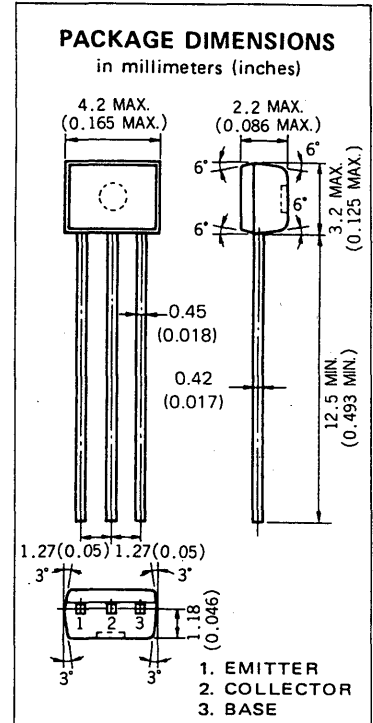

ELECTRICAL CHARACTERISTICS ($T_a = 25^\circ\text{C}$)

SYMBOL	CHARACTERISTIC	MIN.	TYP.	MAX.	UNIT	TEST CONDITIONS
t_{on}	Turn-on Time			70	ns	See Test Circuit.
t_{stg}	Storage Time		110	225	ns	See Test Circuit.
t_{off}	Turn-off Time			300	ns	See Test Circuit.
f_T	Gain Bandwidth Product	200	510		MHz	$V_{CE} = -20\text{ V}$, $I_E = 10\text{ mA}$, $f = 100\text{ MHz}$
C_{ob}	Output Capacitance		2.5	4.5	pF	$V_{CB} = -5.0\text{ V}$, $I_E = 0$, $f = 1\text{ MHz}$
h_{FE1}^*	DC Current Gain	75	180	300	-	$V_{CE} = -1.0\text{ V}$, $I_C = -100\text{ mA}$
h_{FE2}^*	DC Current Gain	25	100		-	$V_{CE} = -1.0\text{ V}$, $I_C = -1.0\text{ mA}$
$V_{CE(sat)}^*$	Collector Saturation Voltage		-0.1	-0.4	V	$I_C = -50\text{ mA}$, $I_B = -5.0\text{ mA}$
$V_{BE(sat)}^*$	Base Saturation Voltage		-0.80	-0.95	V	$I_C = -50\text{ mA}$, $I_B = -5.0\text{ mA}$
I_{CBO}	Collector Cutoff Current			-0.1	μA	$V_{CB} = -30\text{ V}$, $I_E = 0$
I_{EBO}	Emitter Cutoff Current			-0.1	μA	$V_{EB} = -3.0\text{ V}$, $I_C = 0$

* Pulsed PW $\leq 350\ \mu\text{s}$, Duty Cycle $\leq 2\%$

Classification of h_{FE1}

Rank	M	L	K
Range	75 to 150	100 to 200	150 to 300

h_{FE1} Test Conditions : $V_{CE} = -1.0\text{ V}$, $I_C = -100\text{ mA}$

TYPICAL CHARACTERISTICS ($T_a = 25^\circ\text{C}$)

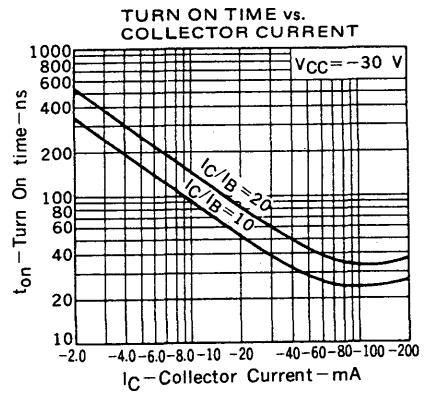
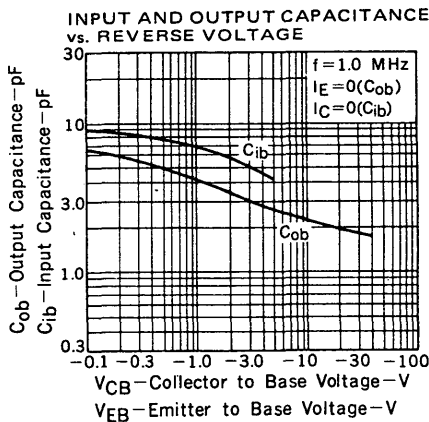
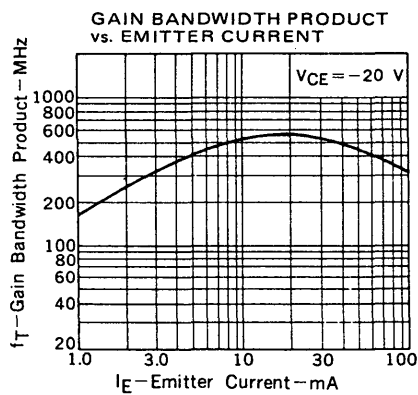
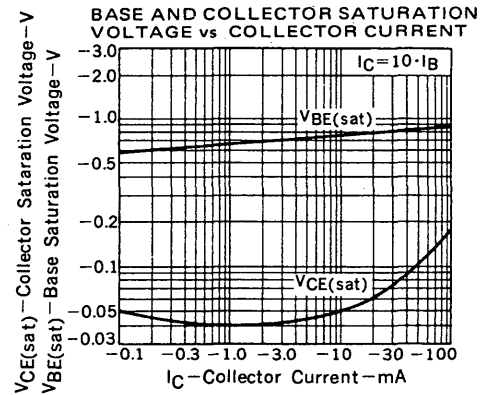
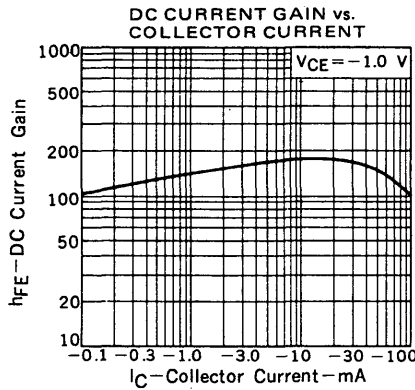
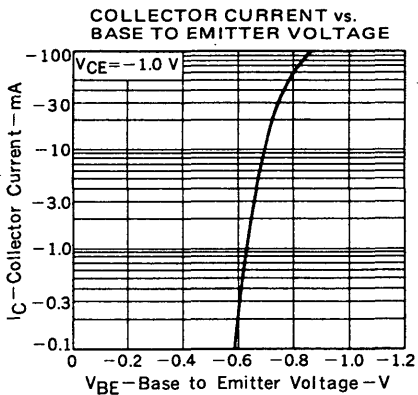
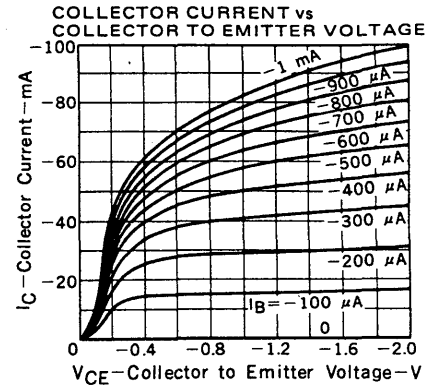
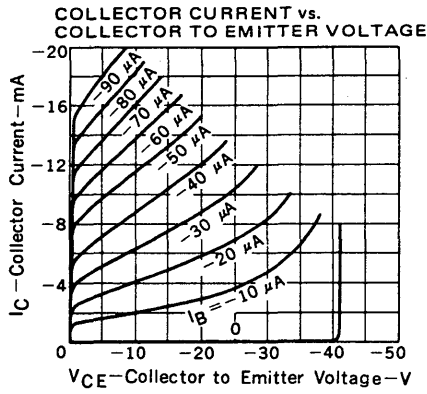
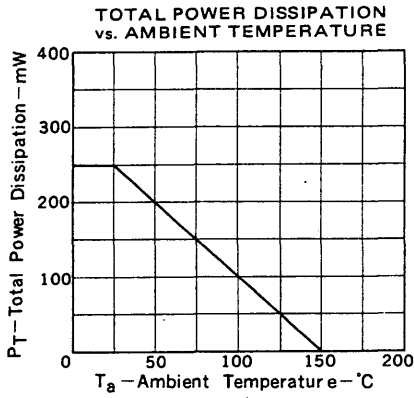

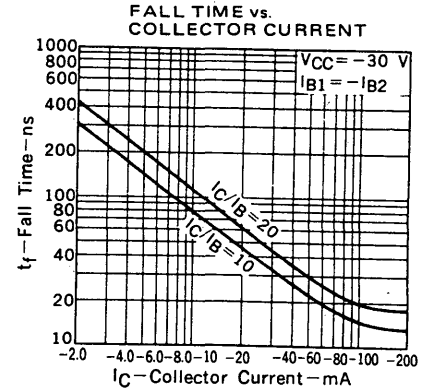
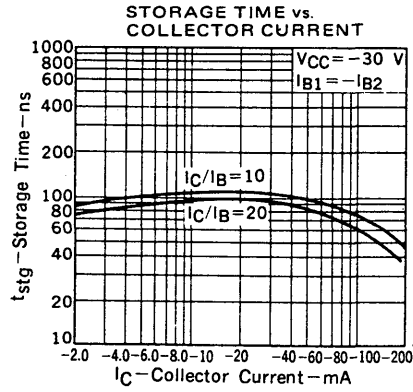
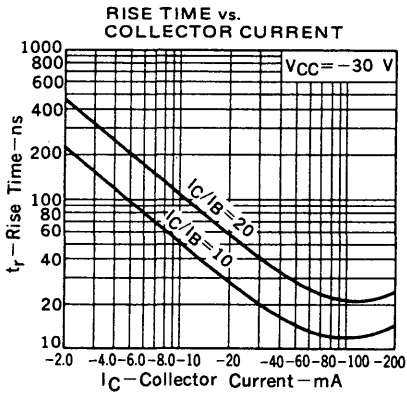

SWITCHING TIME TEST CIRCUIT

