

2SA1510, 2SC3900



2018A

T-37-13
T-35-11
PNP/NPN Epitaxial Planar
Silicon Transistors

Switching Applications (with Bias Resistance R1=4.7kΩ)

©2104A

Applications

- Switching circuits, inverter circuits, interface circuits, driver circuits

Features

- On-chip bias resistance: R1=4.7kohms
- Small-sized package: CP

():2SA1510

Absolute Maximum Ratings at Ta=25°C		unit
Collector to Base Voltage	V_{CBO}	(-)50 V
Collector to Emitter Voltage	V_{CEO}	(-)50 V
Emitter to Base Voltage	V_{EBO}	(-)5 V
Collector Current	I_C	(-)100 mA
Peak Collector Current	i_C	(-)200 mA
Collector Dissipation	P_C	200 mW
Junction Temperature	T_j	150 °C
Storage Temperature	T_{stg}	-55 to +150 °C

Electrical Characteristics at Ta=25°C		min	typ	max	unit
Collector Cutoff Current	I_{CBO} $V_{CB} = (-)40V, I_E = 0$			(-)0.1	uA
Emitter Cutoff Current	I_{EBO} $V_{EB} = (-)5V, I_C = 0$			(-)0.1	uA
DC Current Gain	h_{FE} $V_{CE} = (-)5V, I_C = (-)10mA$	100			
Gain-Bandwidth Product	f_T $V_{CE} = (-)10V, I_C = (-)5mA$		250 (200)		MHz
Output Capacitance	c_{ob} $V_{CB} = (-)10V, f = 1MHz$		3.7 (5.5)		pF
Collector to Emitter Saturation Voltage	$V_{CE(sat)}$ $I_C = (-)10mA, I_B = (-)0.5mA$		(-)0.1(-)0.3		V
Collector to Base Breakdown Voltage	$V_{(BR)CBO}$ $I_C = (-)10uA, I_E = 0$	(-)50			V
Collector to Emitter Breakdown Voltage	$V_{(BR)CEO}$ $I_C = (-)100uA, R_{BE} = \infty$	(-)50			V

Continued on next page.

Marking: 2SA1510: KL, 2SC3900: SY

Electrical Connection

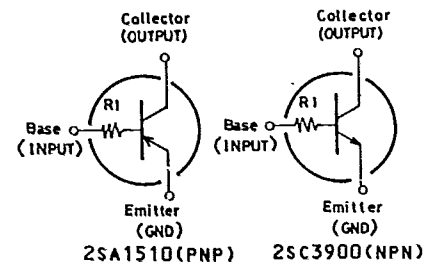

Case Outline 2018A (unit:mm)

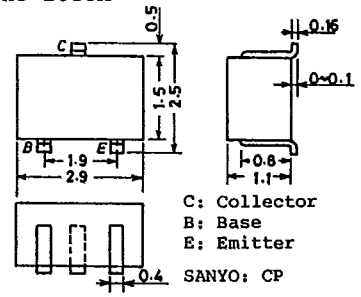

Continued from preceding page.

T-35-11

			min	typ	max	unit
Input OFF-State Voltage	$V_{I(off)}$	$V_{CE} = (-)5V,$ $I_C = (-)100\mu A$	(-)0.4	(-)0.55	(-)0.8	V
Input ON-State Voltage	$V_{I(on)}$	$V_{CE} = (-)0.2V,$ $I_C = (-)10mA$	(-)0.6	(-)1.0	(-)2.0	V
Input Resistance	R_I		3.3	4.7	6.1	kohm

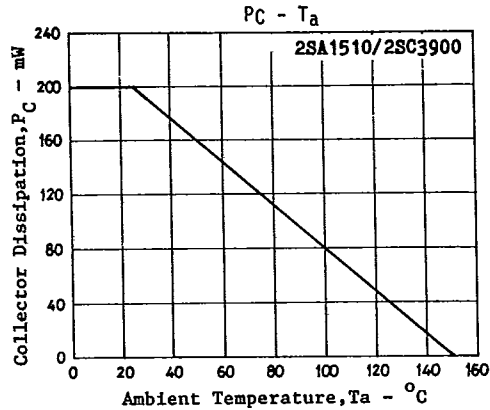
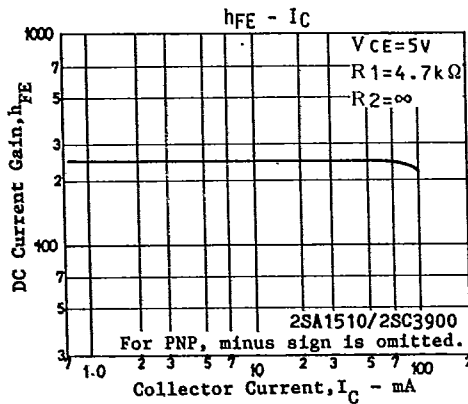
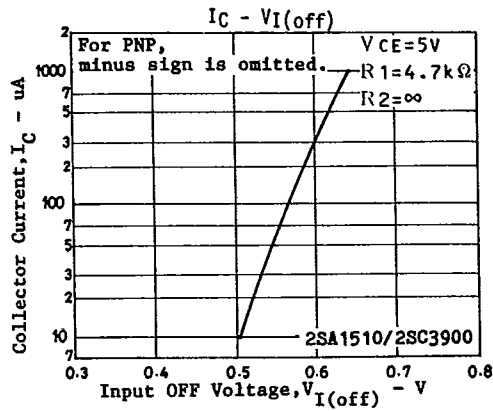
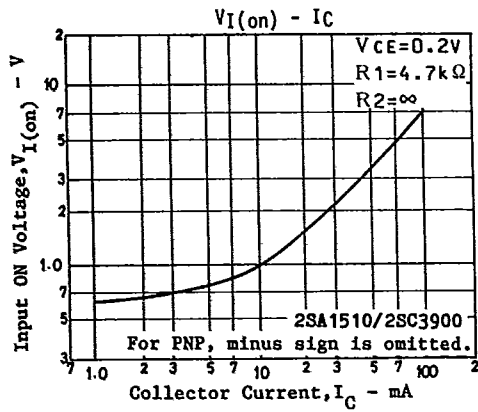

T-91-20

CASE OUTLINES OF SURFACE MOUNT TRANSISTORS

- All of Sanyo surface mount transistor case outlines are illustrated below.
- All dimensions are in mm, and dimensions which are not followed by min. or max. are represented by typical values.
- No marking is indicated.

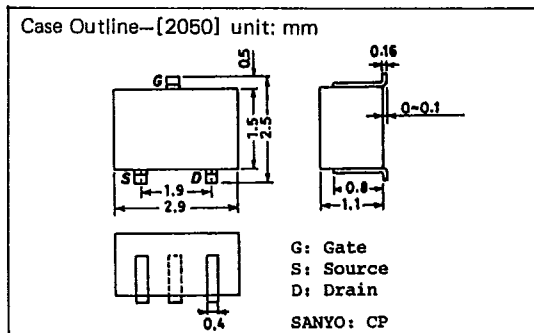
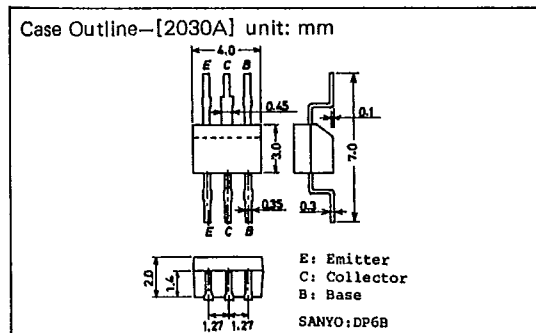
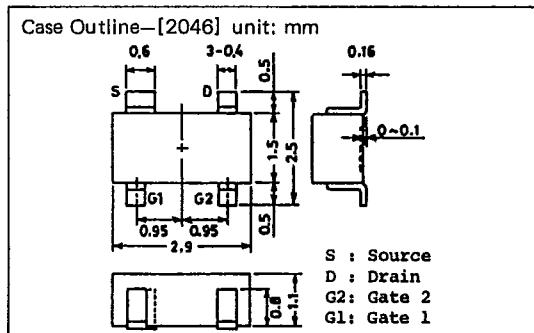
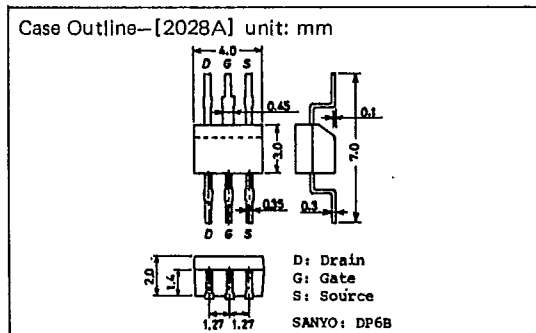
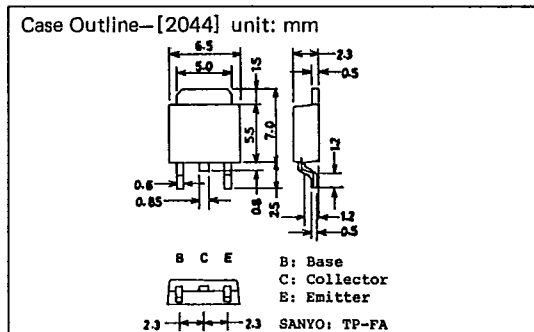
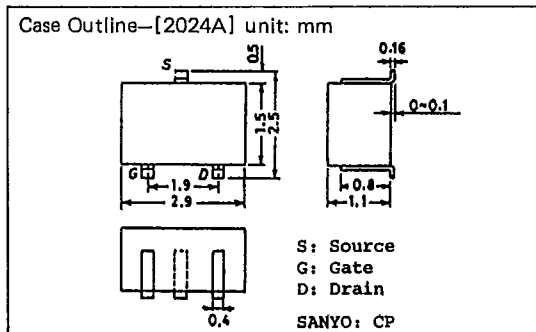
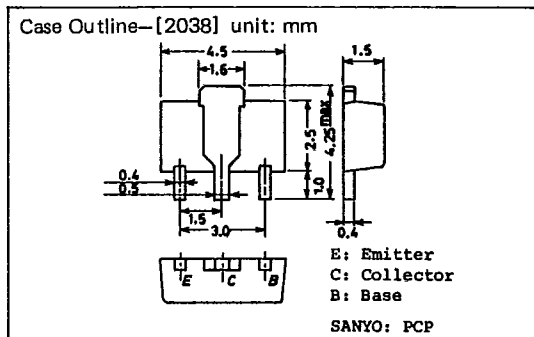
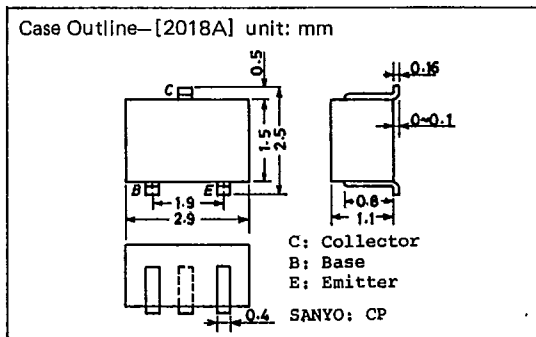

T-91-20

Case Outline—[2057] unit: mm

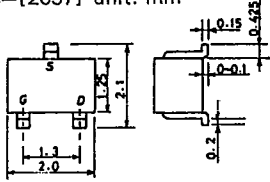

S: Source
G: Gate
D: Drain
SANYO: MCP

Case Outline—[2066] unit: mm

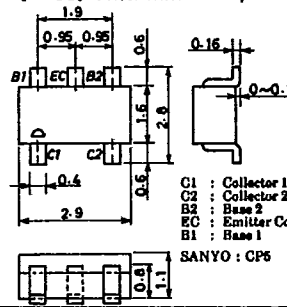

C1 : Collector 1
C2 : Collector 2
B2 : Base 2
EC : Emitter Common
B1 : Base 1
SANYO: CP6

Case Outline—[2058] unit: mm

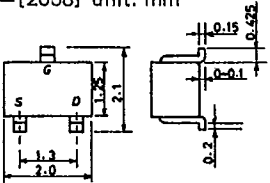

G: Gate
S: Source
D: Drain
SANYO: MCP

Case Outline—[2067] unit: mm

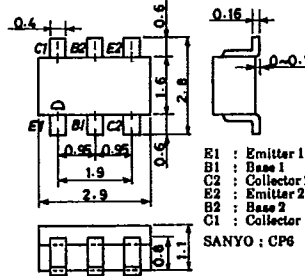

E1 : Emitter 1
B1 : Base 1
C2 : Collector 2
E2 : Emitter 2
B2 : Base 2
C1 : Collector 1
SANYO: CP6

Case Outline—[2059] unit: mm

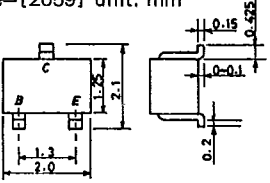

B: Base
C: Collector
E: Emitter
SANYO: MCP

Case Outline—[2068] unit: mm

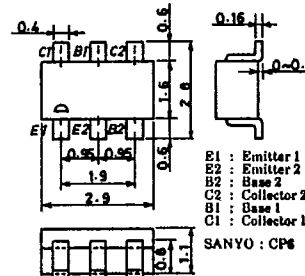

E1 : Emitter 1
E2 : Emitter 2
B2 : Base 2
C2 : Collector 2
B1 : Base 1
C1 : Collector 1
SANYO: CP6

Case Outline—[2062] unit: mm

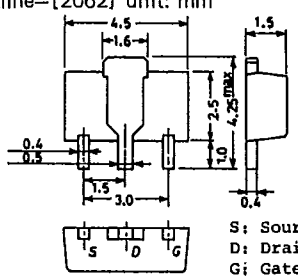

S: Source
D: Drain
G: Gate
SANYO: PCP

Case Outline—[2069] unit: mm

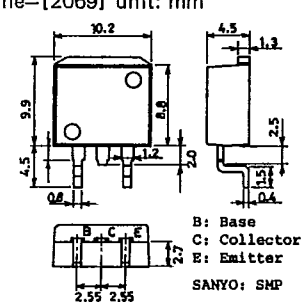

B: Base
C: Collector
E: Emitter
SANYO: SMP

Case Outline—[2065] unit: mm

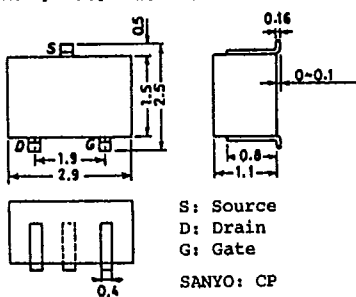

S: Source
D: Drain
G: Gate
SANYO: CP

Case Outline—[2070] unit: mm

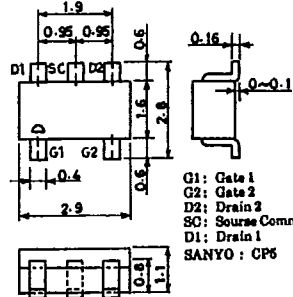

G1 : Gate 1
G2 : Gate 2
D2 : Drain 2
SC : Source Common
D1 : Drain 1
SANYO: CP6

T-9120

