

Silicon PNP Power Transistors

2SA1746

DESCRIPTION

- With TO-3PML package
- Low collector saturation voltage

APPLICATIONS

- For chopper regulator,switch and general purpose applications

PINNING

PIN	DESCRIPTION
1	Emitter
2	Collector
3	Base

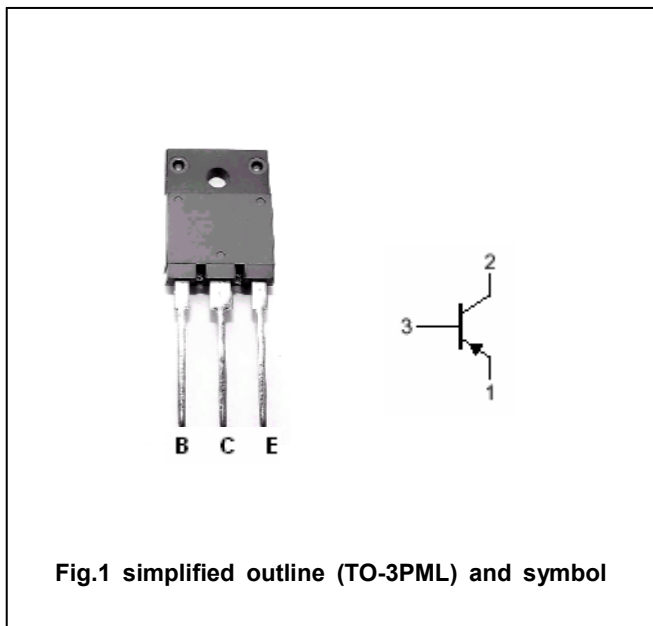

Fig.1 simplified outline (TO-3PML) and symbol

Absolute maximum ratings(Tc=25°C)

SYMBOL	PARAMETER	CONDITIONS	VALUE	UNIT
V _{CBO}	Collector-base voltage	Open emitter	-70	V
V _{CEO}	Collector-emitter voltage	Open base	-50	V
V _{EBO}	Emitter-base voltage	Open collector	-6	V
I _C	Collector current		-12	A
I _{CM}	Collector current-peak		-20	A
I _B	Base current		-4	A
P _C	Collector power dissipation	T _C =25°C	60	W
T _j	Junction temperature		150	°C
T _{stg}	Storage temperature		-55~150	°C

Silicon PNP Power Transistors

2SA1746

CHARACTERISTICS

T_j=25 °C unless otherwise specified

SYMBOL	PARAMETER	CONDITIONS	MIN	TYP.	MAX	UNIT
V _{(BR)CEO}	Collector-emitter breakdown voltage	I _C =-25mA; I _B =0	-50			V
V _{CE(sat)}	Collector-emitter saturation voltage	I _C =-5 A; I _B =-80m A			-0.5	V
V _{BE(sat)}	Base-emitter saturation voltage	I _C =-5 A; I _B =-80m A			-1.2	V
I _{CBO}	Collector cut-off current	V _{CB} =-70V; I _E =0			-10	μA
I _{EBO}	Emitter cut-off current	V _{EB} =-6V; I _C =0			-10	μA
h _{FE}	DC current gain	I _C =-5A ; V _{CE} =-1V	50			
f _T	Transition frequency	I _C =-1A ; V _{CE} =-12V		25		MHz
C _{OB}	Output capacitance	I _E =0; V _{CB} =-10V; f=1MHz		400		pF

Switching times

t _{on}	Turn-on time	I _C =-5A; R _L =4Ω I _{B1} =-I _{B2} =-80mA V _{CC} =-20V		0.5		μs
t _s	Storage time			0.6		μs
t _f	Fall time			0.3		μs

Silicon PNP Power Transistors

2SA1746

PACKAGE OUTLINE

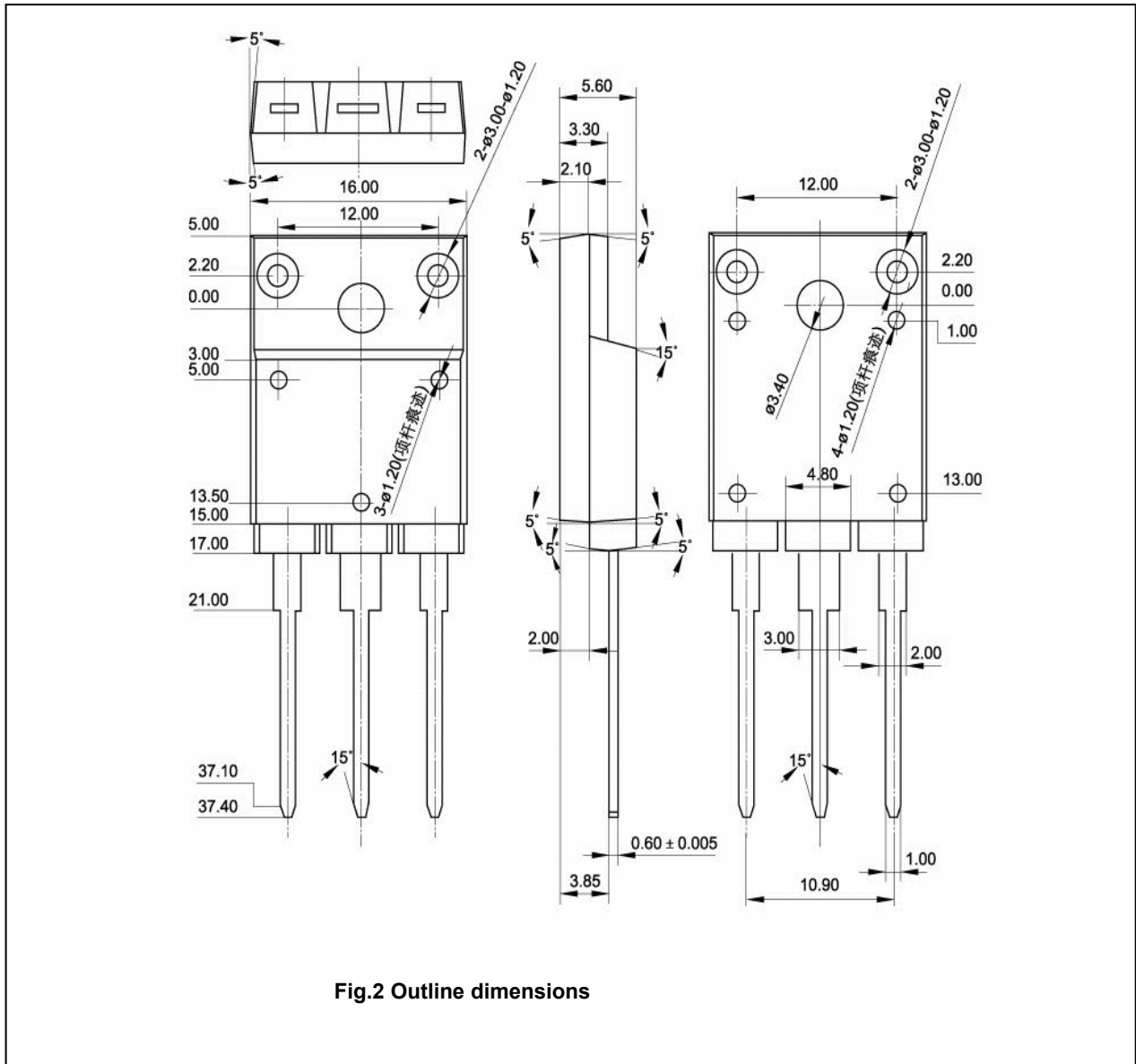

Fig.2 Outline dimensions

Silicon PNP Power Transistors

2SA1746

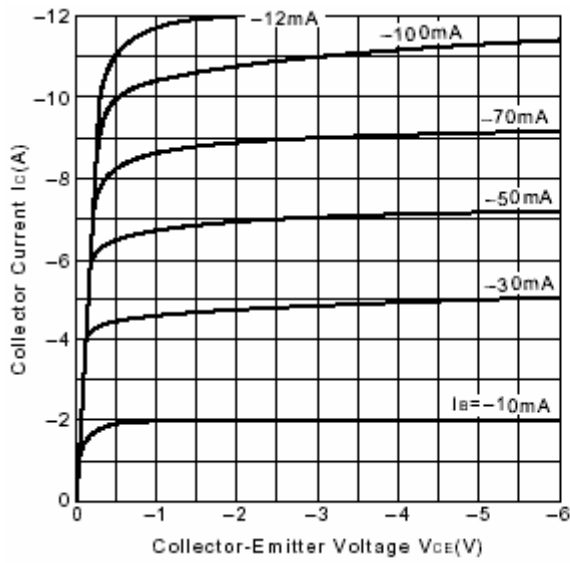

Fig.3 Static Characteristic

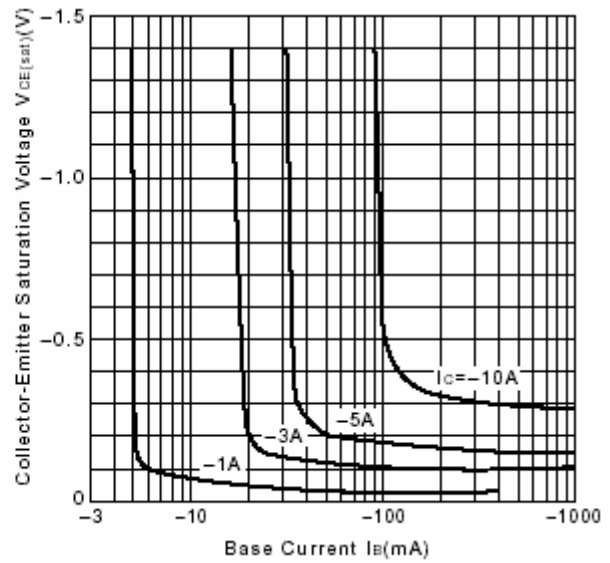

Fig.4 $V_{CE(sat)}-I_B$ Characteristics

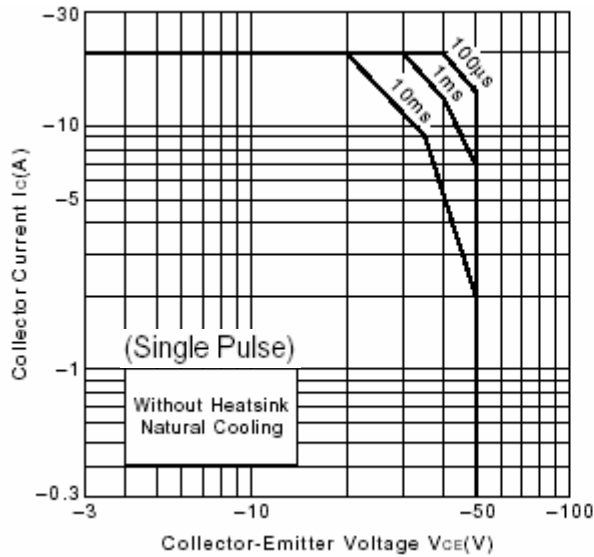

Fig.5 Safe Operating Area

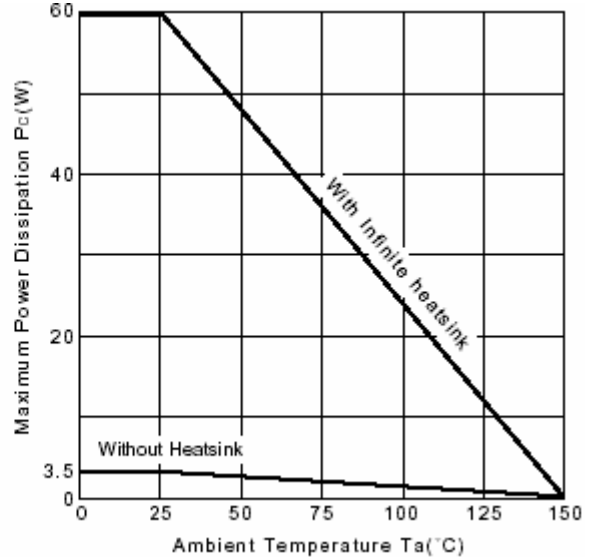

Fig.6 P_c-T_a Derating

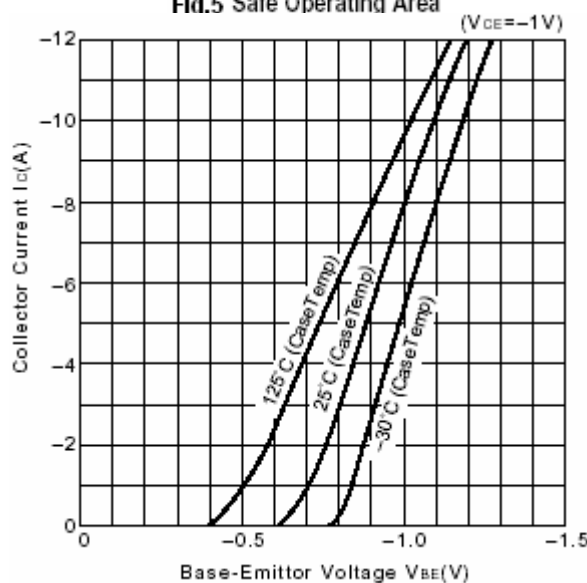

Fig.7 I_C-V_{BE}

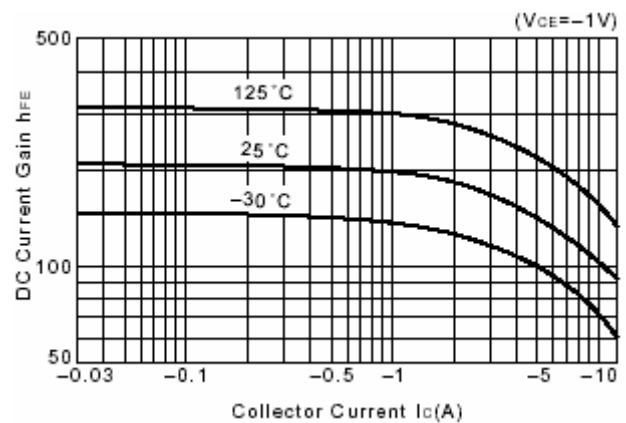

Fig.8 DC current Gain