

<b>SANYO</b>	No.3180B	<b>2SA1764</b>
	PNP Epitaxial Planar Silicon Transistor	
High-Speed Switching Applications		

**Features**

- Fast switching speed
- Low collector saturation voltage
- High gain-bandwidth product
- Small collector capacitance
- Small-sized package permitting the 2SA1764-applied sets to be made small and slim
- Complementary pair with the 2SC4453

**Absolute Maximum Ratings at Ta = 25°C**

			unit
Collector to Base Voltage	$V_{CB0}$	-15	V
Collector to Emitter Voltage	$V_{CEO}$	-15	V
Emitter to Base Voltage	$V_{EBO}$	-5	V
Collector Current	$I_C$	-200	mA
Collector Current(Pulse)	$I_{CP}$	-500	mA
Base Current	$I_B$	-40	mA
Collector Dissipation	$P_C$	200	mW
Junction Temperature	$T_j$	150	°C
Storage Temperature	$T_{stg}$	-55 to +150	°C

**Electrical Characteristics at Ta = 25°C**

			min	typ	max	unit
Collector Cutoff Current	$I_{CBO}$	$V_{CB} = -8V, I_E = 0$			-0.1	$\mu A$
Emitter Cutoff Current	$I_{EBO}$	$V_{EB} = -3V, I_C = 0$			-0.1	$\mu A$
DC Current Gain	$h_{FE}$	$V_{CE} = -1V, I_C = -10mA$	50	80	140	
Gain-Bandwidth Product	$f_T$	$V_{CE} = -10V, I_C = -10mA$	450	1000		MHz
Output Capacitance	$c_{ob}$	$V_{CB} = -5V, f = 1MHz$		1.8	3.0	pF
C-E Saturation Voltage	$V_{CE(sat)}$	$I_C = -10mA, I_B = -1mA$	-0.07	-0.20		V
B-E Saturation Voltage	$V_{BE(sat)}$	$I_C = -10mA, I_B = -1mA$	-0.80	-0.90		V
C-B Breakdown Voltage	$V_{(BR)CBO}$	$I_C = -10\mu A, I_E = 0$	-15			V
C-E Breakdown Voltage	$V_{(BR)CEO}$	$I_C = -1mA, R_{BE} = \infty$	-15			V
E-B Breakdown Voltage	$V_{(BR)EBO}$	$I_E = -10\mu A, I_C = 0$	-5			V
Turn-ON Time	$t_{on}$	See specified Test Circuit.		11		ns
Storage Time	$t_{stg}$	"		21		ns
Turn-OFF Time	$t_{off}$	"		19		ns

Marking : FS

**Package Dimensions 2018A**  
(unit : mm)

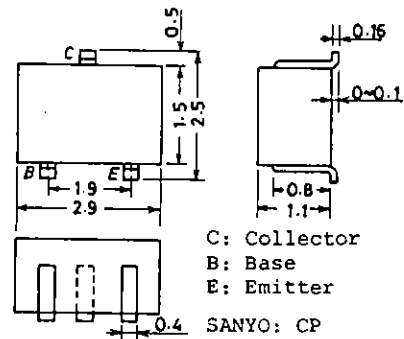

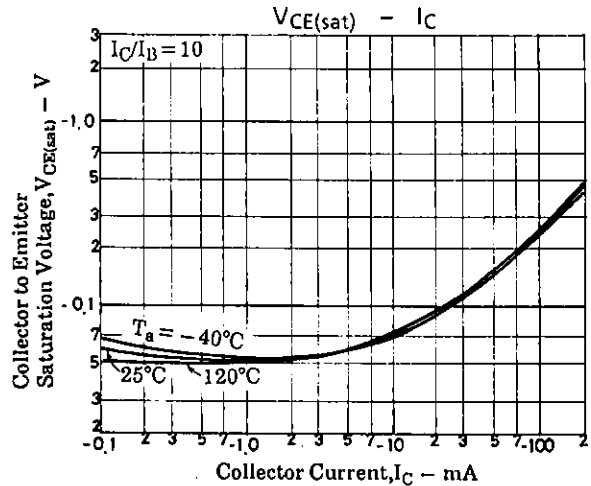
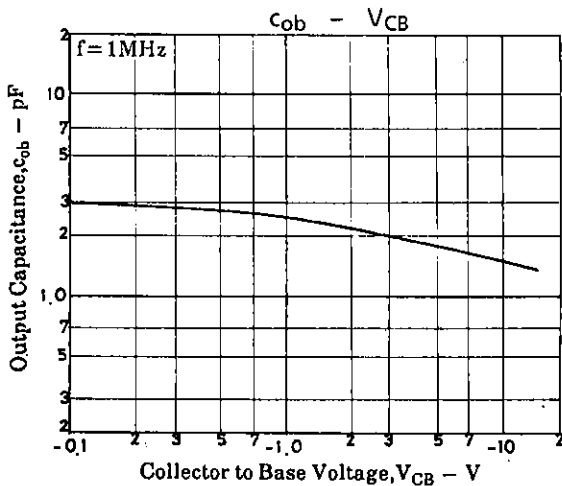
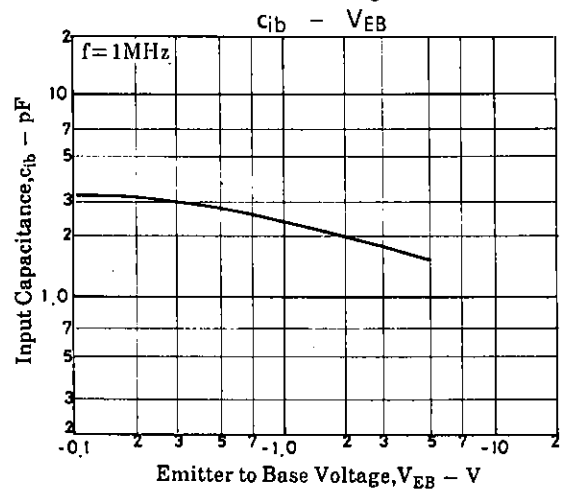
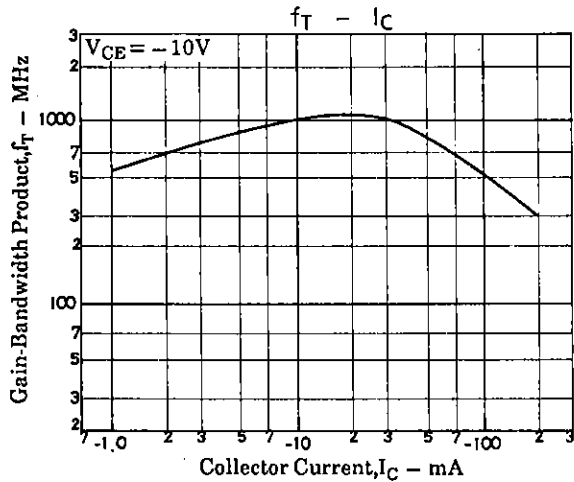
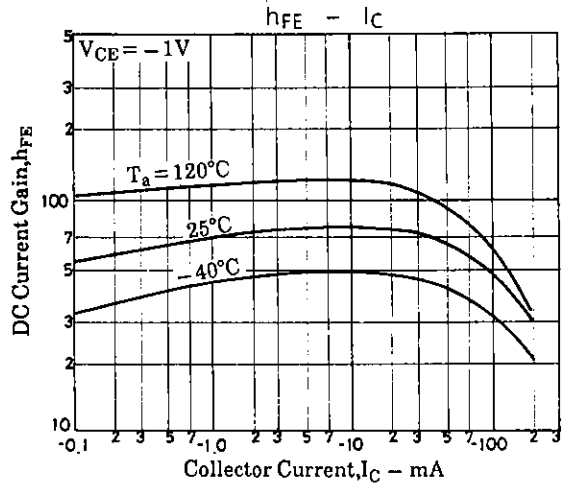
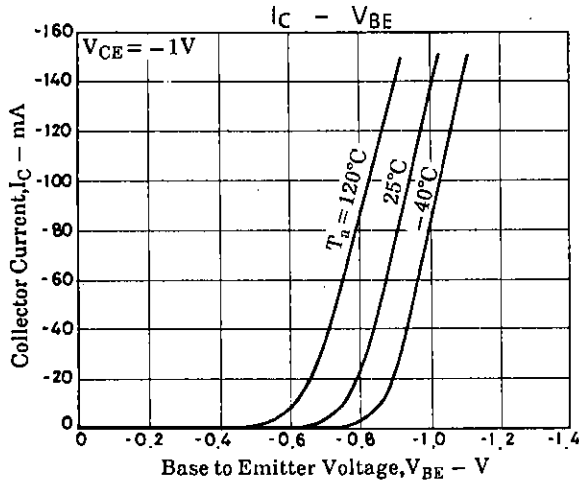
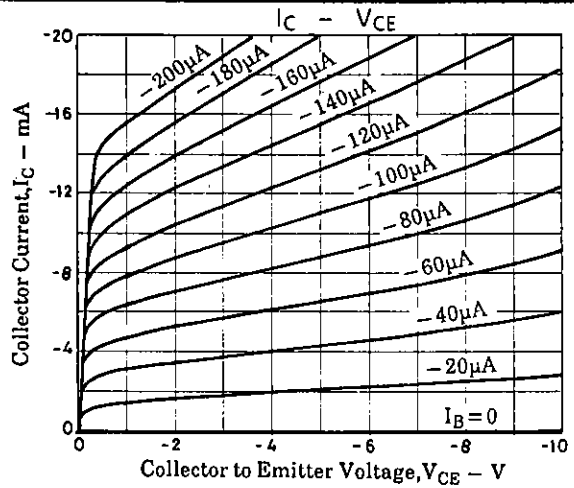
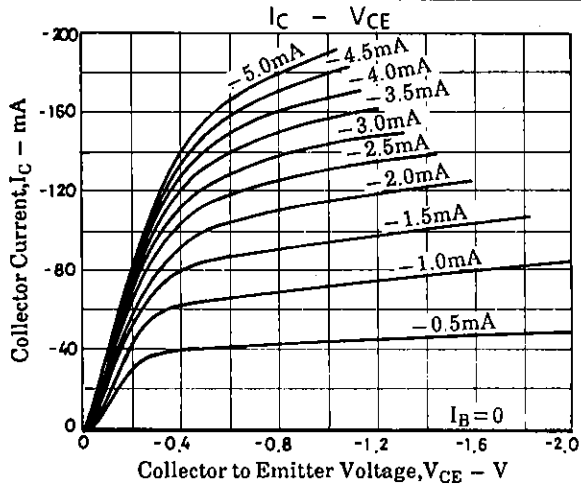

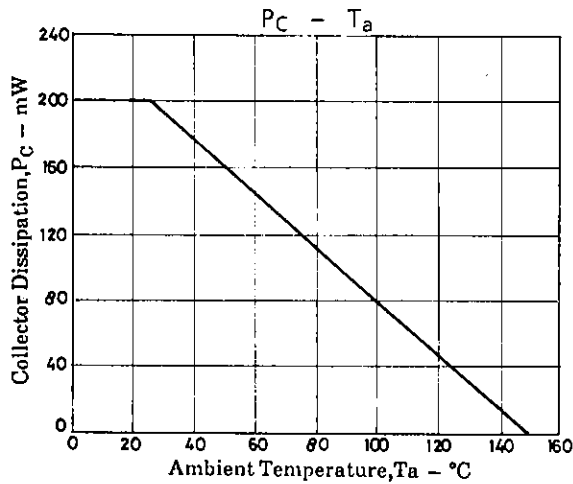
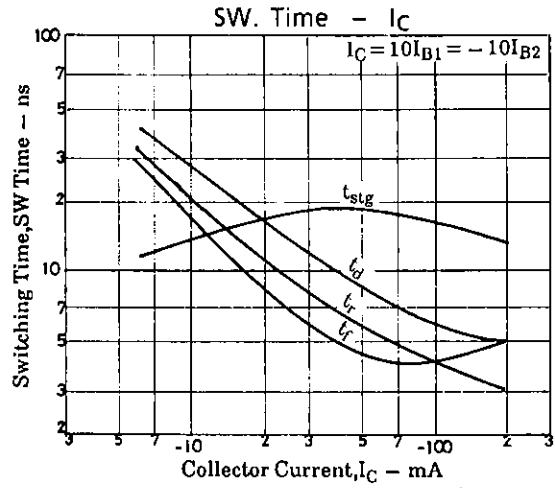
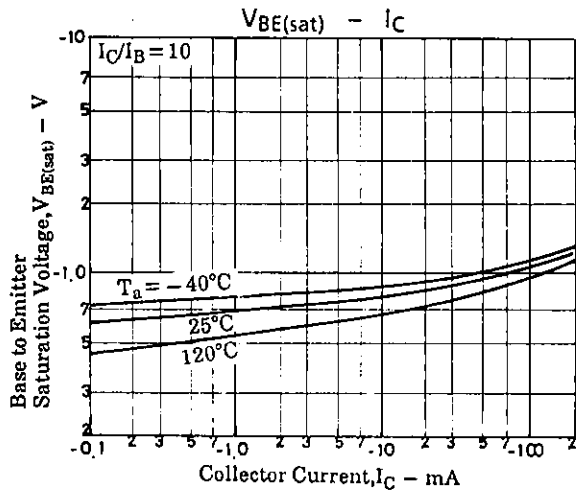

**Switching Time Test Circuits**

**$t_{on}, t_{off}$  Test Circuit**

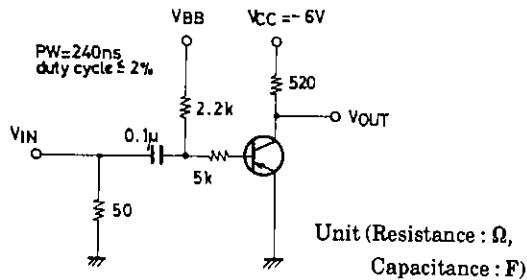

**$t_{stg}$  Test Circuit**

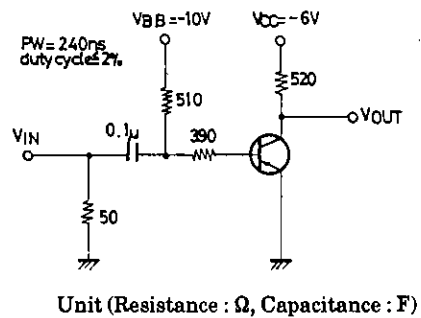

**$t_{on}$  Test Waveform ( $V_{BB} = GND$ )**

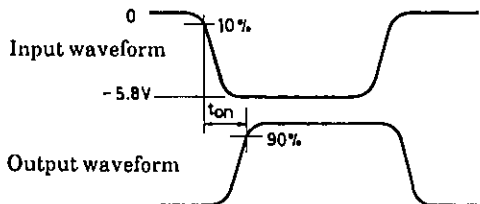

**$t_{off}$  Test Waveform ( $V_{BB} = -8.0V$ )**

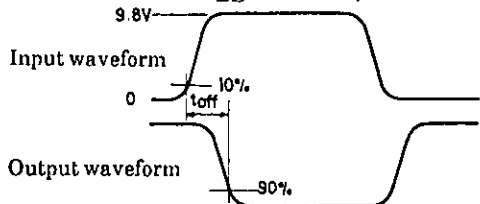

**$t_{stg}$  Test Waveform**

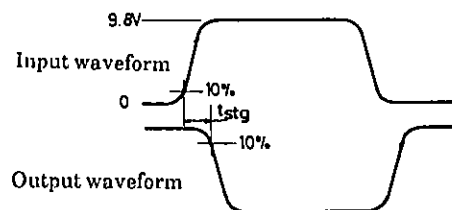

- No products described or contained herein are intended for use in surgical implants, life-support systems, aerospace equipment, nuclear power control systems, vehicles, disaster/crime-prevention equipment and the like, the failure of which may directly or indirectly cause injury, death or property loss.
- Anyone purchasing any products described or contained herein for an above-mentioned use shall:
  - ① Accept full responsibility and indemnify and defend SANYO ELECTRIC CO., LTD., its affiliates, subsidiaries and distributors and all their officers and employees, jointly and severally, against any and all claims and litigation and all damages, cost and expenses associated with such use:
  - ② Not impose any responsibility for any fault or negligence which may be cited in any such claim or litigation on SANYO ELECTRIC CO., LTD., its affiliates, subsidiaries and distributors or any of their officers and employees jointly or severally.
- Information (including circuit diagrams and circuit parameters) herein is for example only; it is not guaranteed for volume production. SANYO believes information herein is accurate and reliable, but no guarantees are made or implied regarding its use or any infringements of intellectual property rights or other rights of third parties.