

Silicon PNP Power Transistors

2SA1908

DESCRIPTION

- With TO-3PML package
- Complement to type 2SC5100

APPLICATIONS

- Audio and general purpose

PINNING

PIN	DESCRIPTION
1	Emitter
2	Collector
3	Base

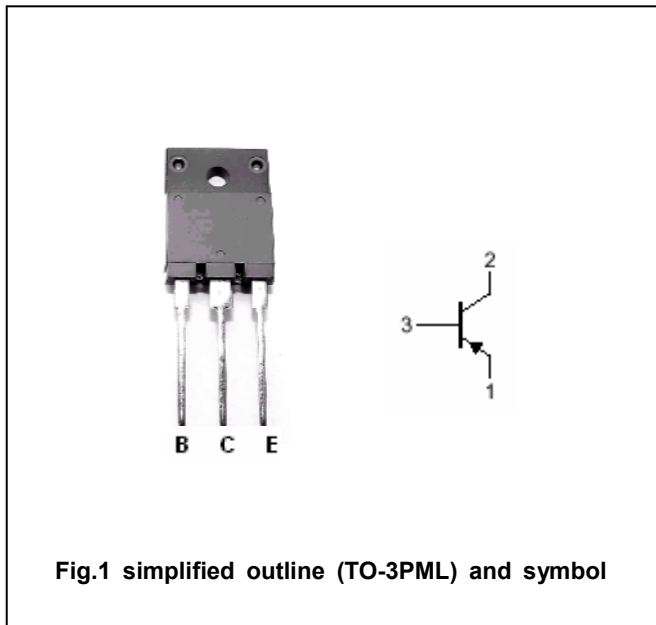

Absolute maximum ratings(Tc=25°C)

SYMBOL	PARAMETER	CONDITIONS	VALUE	UNIT
V _{CBO}	Collector-base voltage	Open emitter	-120	V
V _{CEO}	Collector-emitter voltage	Open base	-120	V
V _{EBO}	Emitter-base voltage	Open collector	-6	V
I _C	Collector current		-8	A
I _B	Base current		-3	A
P _C	Collector power dissipation	T _C =25°C	75	W
T _j	Junction temperature		150	°C
T _{stg}	Storage temperature		-55~150	°C

Silicon PNP Power Transistors

2SA1908

CHARACTERISTICS

T_j=25 °C unless otherwise specified

SYMBOL	PARAMETER	CONDITIONS	MIN	TYP.	MAX	UNIT
V _{(BR)CEO}	Collector-emitter breakdown voltage	I _C =-50mA; I _B =0	-120			V
V _{CEsat}	Collector-emitter saturation voltage	I _C =-3 A; I _B =-0.3 A			-0.5	V
I _{CBO}	Collector cut-off current	V _{CB} =-120V; I _E =0			-10	μA
I _{EBO}	Emitter cut-off current	V _{EB} =-6V; I _C =0			-10	μA
h _{FE}	DC current gain	I _C =-3A ; V _{CE} =-4V	50		180	
f _T	Transition frequency	I _C =-0.5A ; V _{CE} =-12V		20		MHz
C _{OB}	Output capacitance	I _E =0; V _{CB} =-10V; f=1MHz		300		pF

Switching times

t _{on}	Turn-on time	I _C =-4A; R _L =10Ω I _{B1} =-I _{B2} =-0.4A V _{CC} =-40V		0.14		μs
t _s	Storage time			1.40		μs
t _f	Fall time			0.21		μs

◆ h_{FE} classifications

O	P	Y
50-100	70-140	90-180

Silicon PNP Power Transistors

2SA1908

PACKAGE OUTLINE

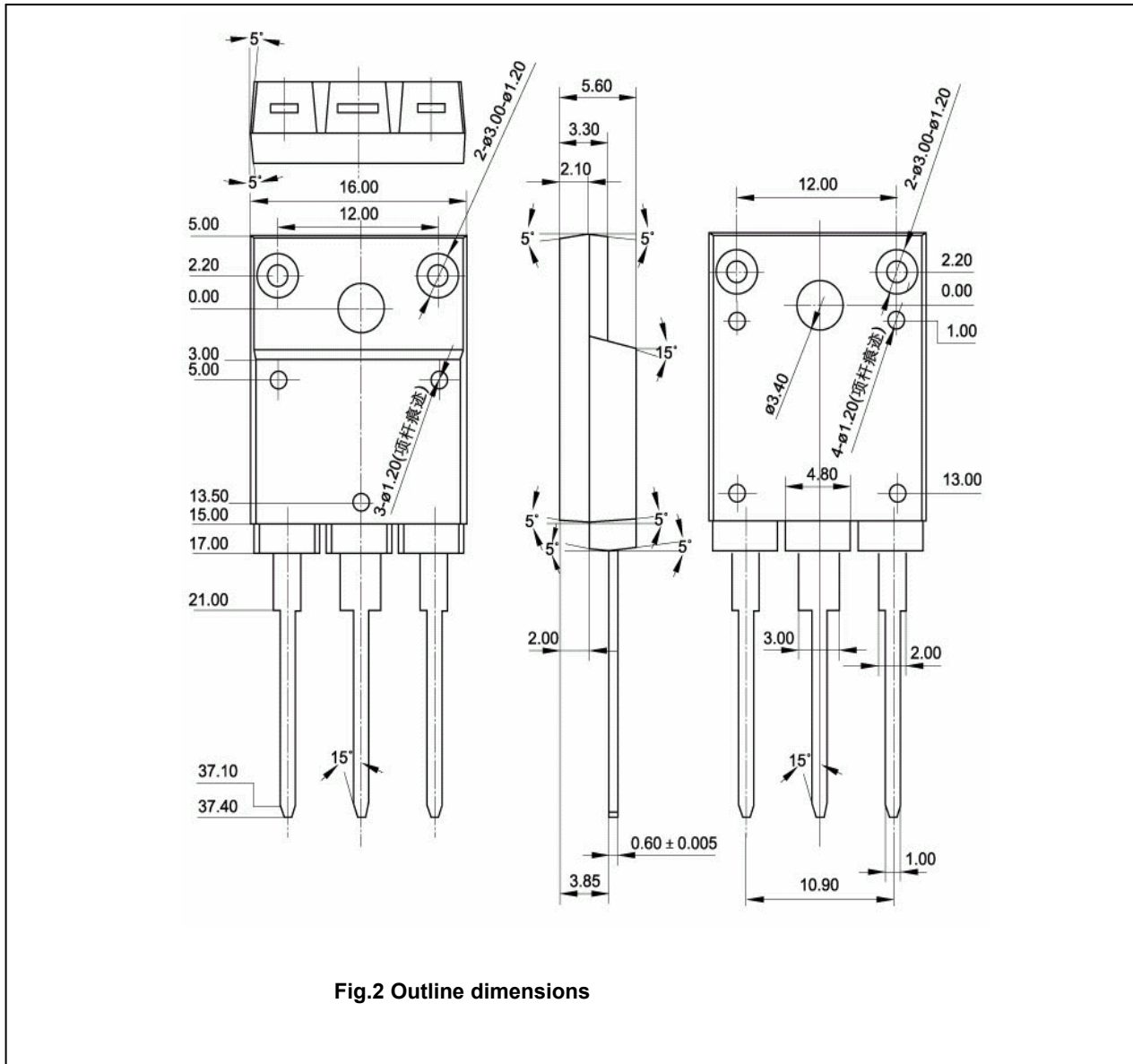

Fig.2 Outline dimensions

Silicon PNP Power Transistors

2SA1908

www.DataSheet4U.com

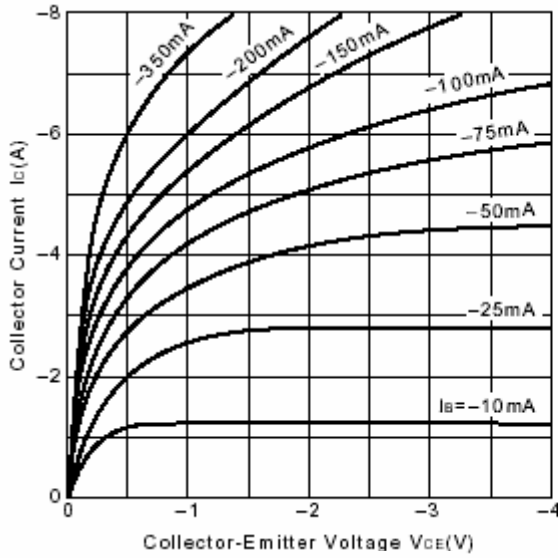

Fig.3 Static Characteristic

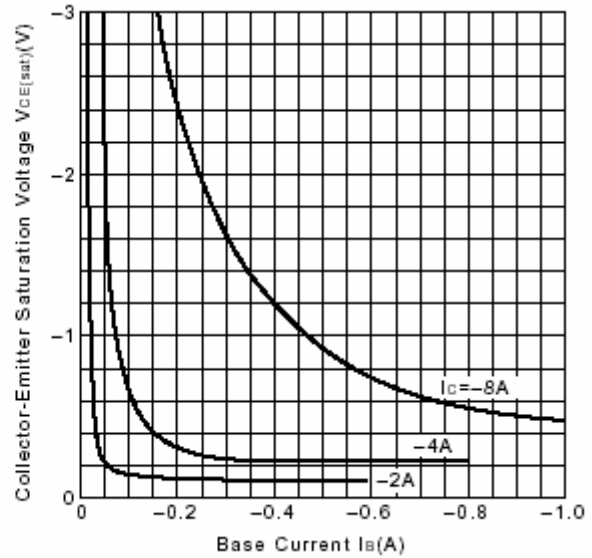

Fig.4 $V_{CE(sat)}$ - I_B Characteristics

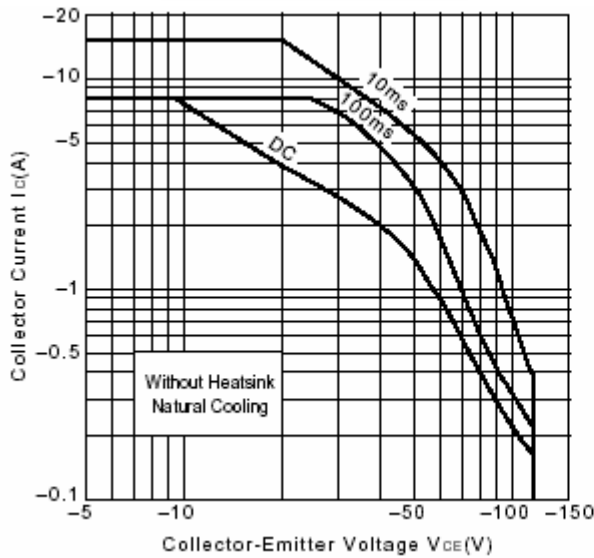

Fig.5 Safe Operating Area

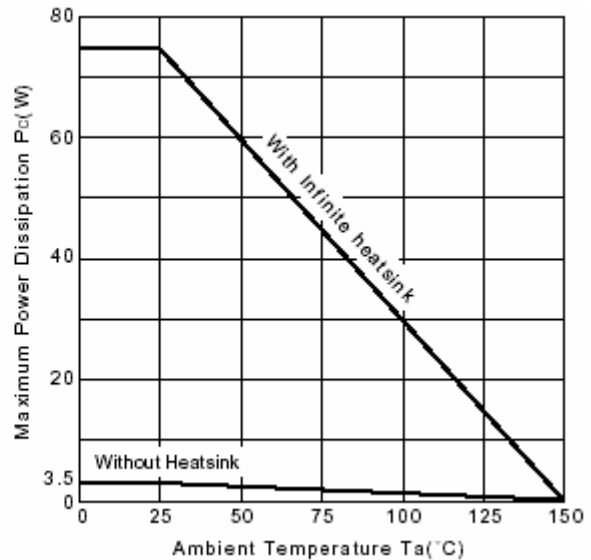

Fig.6 P_c - T_a Derating

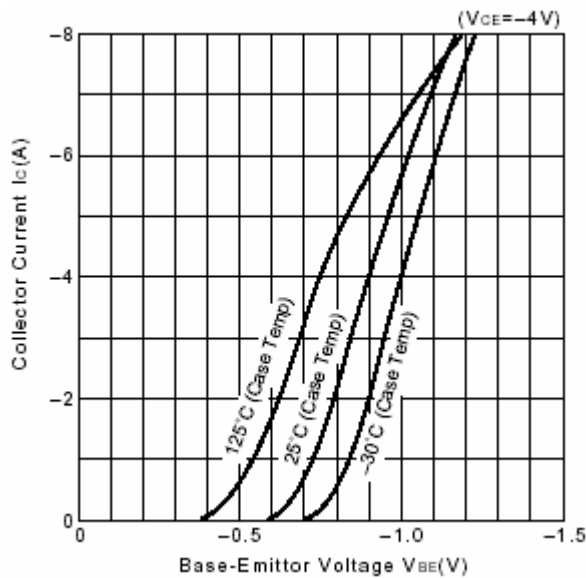

Fig.7 I_C - V_{BE}

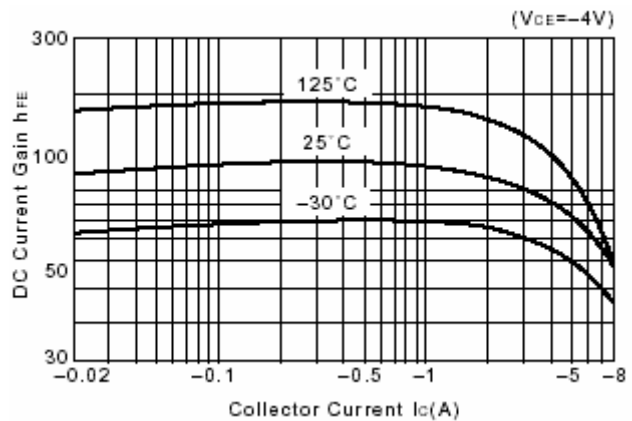

Fig.8 DC current Gain