

# HITACHI TRANSISTORS

—FOR COMPLEMENTARY SYMMETRY OTL AMP.—

## 2SA537 2SA537A

The Hitachi 2SA537 and 2SA537A are silicon PNP epitaxial planar type transistors with high breakdown voltage and good linearity of DC current transfer ratio, specifically designed for use in the driver stage of high fidelity audio amplifier, especially featuring in complementary symmetry with the Hitachi transistor 2SC708 and 2SC708A.

### ABSOLUTE MAXIMUM RATINGS (At 25°C Ambient Temperature)

Item	Symbol	2SA537	2SA537A	Unit
Collector to Base Voltage	$V_{CBO}$	-60	-90	V
Collector to Emitter Voltage	$V_{CEO}$	-50	-80	V
Emitter to Base Voltage	$V_{EBO}$	-4	-4	V
Collector Current	$I_C$	-0.7	-0.7	A
Collector Dissipation	$P_C$	0.75	0.75	W
Junction Temperature	$T_j$	200	200	°C
Storage Temperature	$T_{stg}$	-65~+200	-65~+200	°C

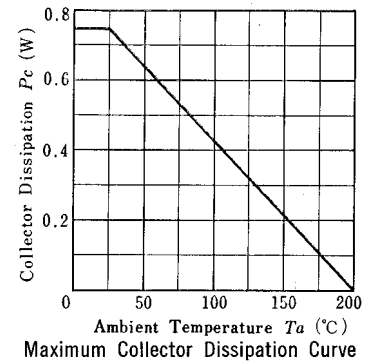
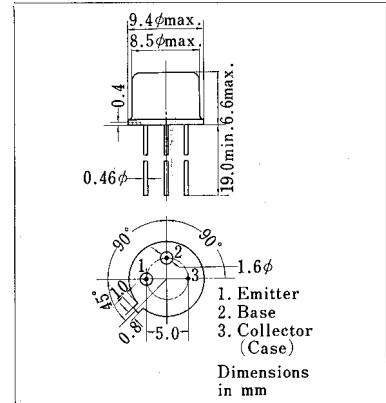

### ELECTRICAL CHARACTERISTICS (At 25°C Ambient Temperature)

Item	Symbol	Test Condition	2SA537			2SA537A			Unit
			min.	typ.	max.	min.	typ.	max.	
Collector to Emitter Breakdown Voltage	$V_{(BR)CEO}$	$I_C = -10 \text{ mA}$ , $R_{BE} = \infty$	-50	—	—	-80	—	—	V
Emitter to Base Breakdown Voltage	$V_{(BR)EBO}$	$I_E = -5 \text{ mA}$ , $I_C = 0$	-4	—	—	-4	—	—	V
DC Current Transfer Ratio*	$h_{FE}$	$V_{CE} = -4 \text{ V}$ , $I_C = -50 \text{ mA}$	35	80	200	35	80	200	
		$V_{CE} = -4 \text{ V}$ , $I_C = -400 \text{ mA (pulse)}$	20	40	—	20	40	—	
Base to Emitter Voltage	$V_{BE}$	$V_{CE} = -4 \text{ V}$ , $I_C = -50 \text{ mA}$	—	-0.8	-1.0	—	-0.8	-1.0	V
Collector to Emitter Saturation Voltage	$V_{CE(sat)}$	$I_C = -150 \text{ mA}$ , $I_B = -15 \text{ mA}$	—	-0.5	-1.0	—	-0.5	-1.0	V
Gain Bandwidth Product	$f_T$	$V_{CE} = -4 \text{ V}$ , $I_C = -30 \text{ mA}$	—	200	—	—	200	—	MHz

\* The 2SA537 and 2SA537A are grouped by  $h_{FE}$  ( $V_{CE} = -4 \text{ V}$ ,  $I_C = -50 \text{ mA}$ ) as follows.

Ⓐ 35~70, Ⓑ 60~120, Ⓒ 100~200

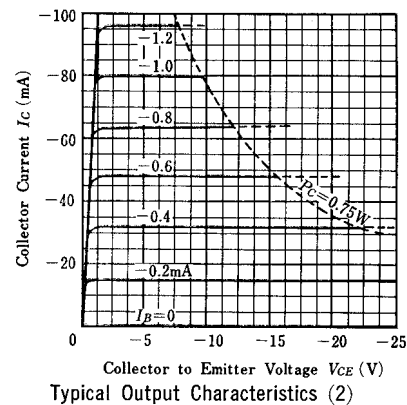
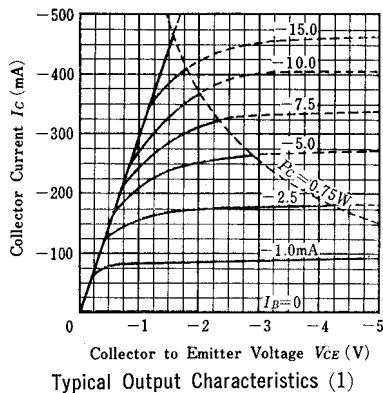

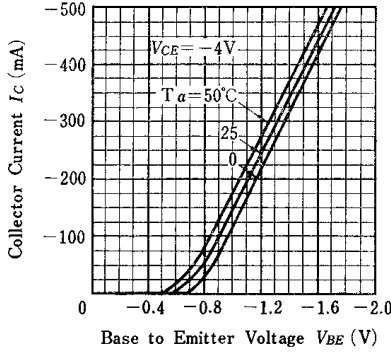

Typical Transfer Characteristics

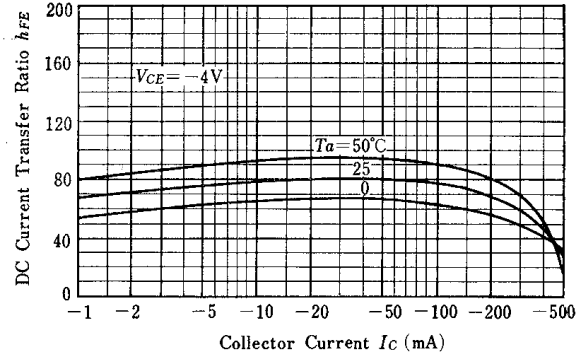

DC Current Transfer Ratio vs. Collector Current

## CIRCUIT EXAMPLE—5W Complementary OTL Amplifier

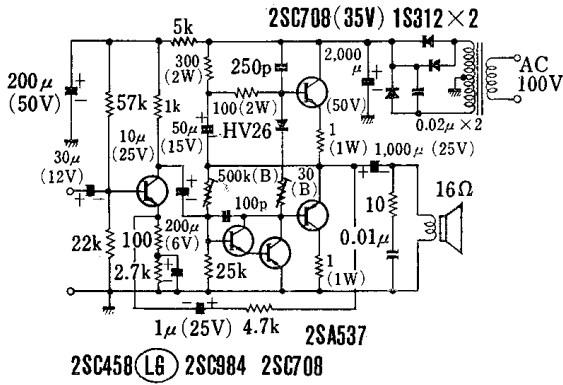

- Note) 1. Resistors are  $\frac{1}{2}$  watt unless otherwise specified.  
2. The 2SA537 and 2SC708 attach on the heat sink fin.

### Performance Data

- Power Gain .....67 dB
- Power Output .....5 W (*Dist.*=0.5%)
- Frequency Characteristic .....20 Hz~60 kHz (at -2 dB)
- Input Impedance .....15 kΩ min.
- Negative Feedback .....30 dB

