

2SB1072(L), 2SB1072(S)

SILICON PNP TRIPLE DIFFUSED

MEDIUM SPEED POWER AMPLIFIER

COMPLEMENTARY PAIR WITH 2SD1520(L)/(S)

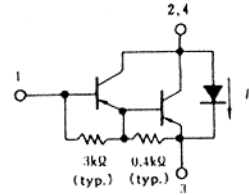
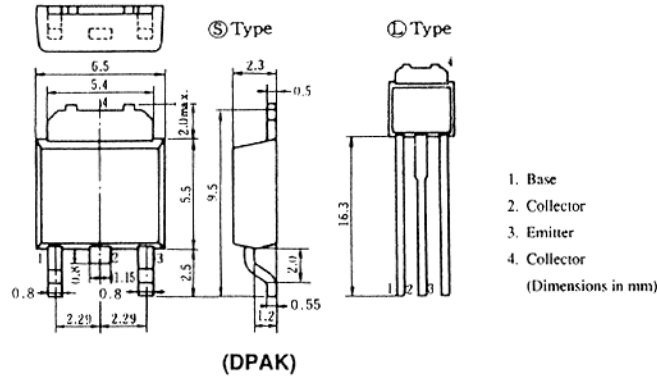

■ ABSOLUTE MAXIMUM RATINGS (Ta=25°C)

Item	Symbol	2SB1072(L), 2SB1072(S)	Unit
Collector to base voltage	V _{CB0}	-100	V
Collector to emitter voltage	V _{CEO}	-80	V
Emitter to base voltage	V _{EBO}	-7	V
Collector current	I _C	-4	A
C to E diode forward current	I _{D*}	4	A
Collector peak current	i _{C(peak)}	-8	A
Collector power dissipation	P _{C*}	20	W
Junction temperature	T _j	150	°C
Storage temperature	T _{stg}	-55 to +150	°C

* Value at T_c = 25°C

MAXIMUM COLLECTOR DISSIPATION CURVE

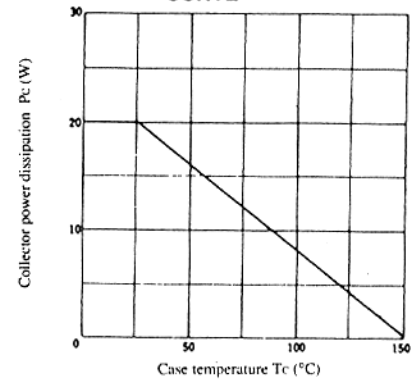

■ ELECTRICAL CHARACTERISTICS (Ta=25°C)

Item	Symbol	Test Condition	min.	typ.	max.	Unit
Collector to emitter breakdown voltage	V _{(BR)CEO}	I _C = -25mA, R _{BE} = ∞	-80	—	—	V
Emitter to base breakdown voltage	V _{(BR)EBO}	I _E = -50mA, I _C = 0	-7	—	—	V
Collector cutoff current	I _{CBO}	V _{CB} = -80V, I _E = 0	—	—	-100	μA
	I _{CEO}	V _{CE} = -60V, R _{BE} = ∞	—	—	-10	μA
DC current transfer ratio	h _{FE}	V _{CE} = -3V, I _C = -2A*	1000	—	20000	
Collector to emitter saturation voltage	V _{CE(sat)1}	I _C = -2A, I _B = -4mA*	—	—	-1.5	V
	V _{CE(sat)2}	I _C = -4A, I _B = -40mA*	—	—	-3.0	V
Base to emitter saturation voltage	V _{BE(sat)1}	I _C = -2A, I _B = -4mA*	—	—	-2.0	V
	V _{BE(sat)2}	I _C = -4A, I _B = -40mA*	—	—	-3.5	V
C to E diode forward voltage	V _D	I _D = 4A*	—	—	3.0	V
Turn on time	t _{on}	I _C = -2A, I _{B1} = -I _{B2} = -4mA	—	0.5	—	μs
Storage time	t _{stg}		—	1.5	—	μs
Fall time	t _f		—	1.0	—	μs

* Pulse Test.

AREA OF SAFE OPERATION

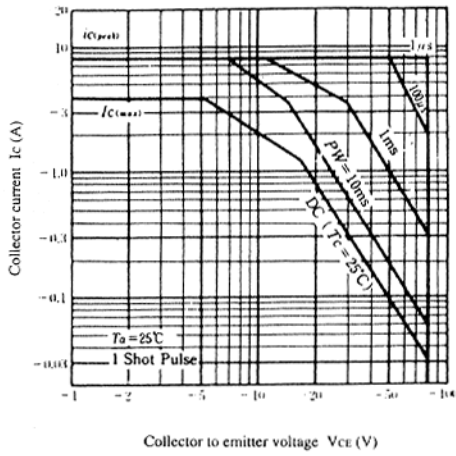

TYPICAL OUTPUT CHARACTERISTICS

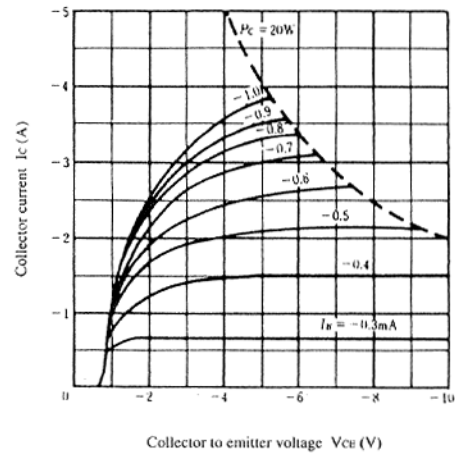

DC CURRENT TRANSFER RATIO VS. COLLECTOR CURRENT

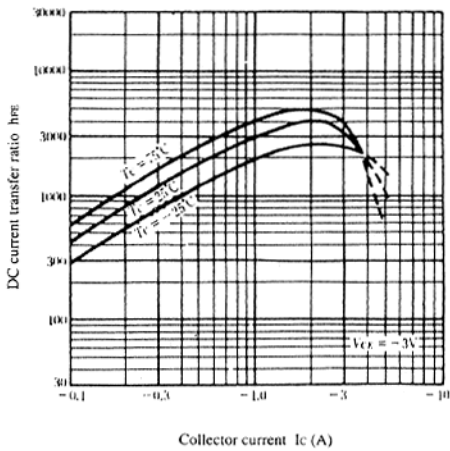

SATURATION VOLTAGE VS. COLLECTOR CURRENT

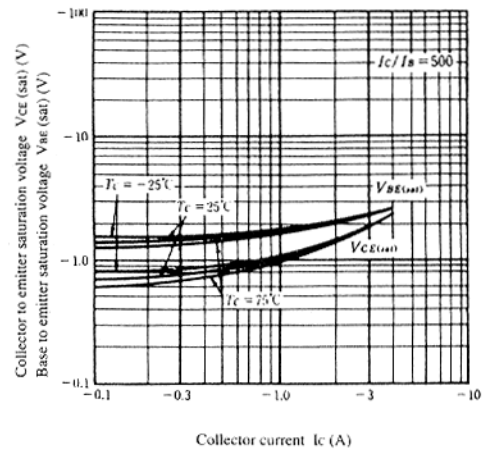

SWITCHING TIME VS. COLLECTOR CURRENT

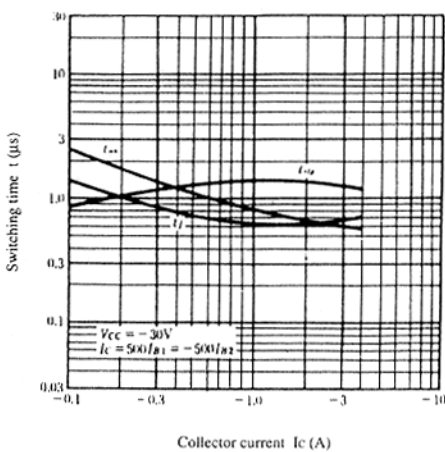

TRANSIENT THERMAL RESISTANCE

