

2SB1221

Silicon PNP epitaxial planer type

For general amplification
Complementary to 2SC3941

■ Features

- Low collector to emitter saturation voltage $V_{CE(sat)}$.
- Allowing supply with the radial taping.

■ Absolute Maximum Ratings (Ta=25°C)

Parameter	Symbol	Ratings	Unit
Collector to base voltage	V_{CBO}	-250	V
Collector to emitter voltage	V_{CEO}	-200	V
Emitter to base voltage	V_{EBO}	-5	V
Peak collector current	I_{CP}	-100	mA
Collector current	I_C	-70	mA
Collector power dissipation	P_C	1	W
Junction temperature	T_j	150	°C
Storage temperature	T_{stg}	-55 ~ +150	°C

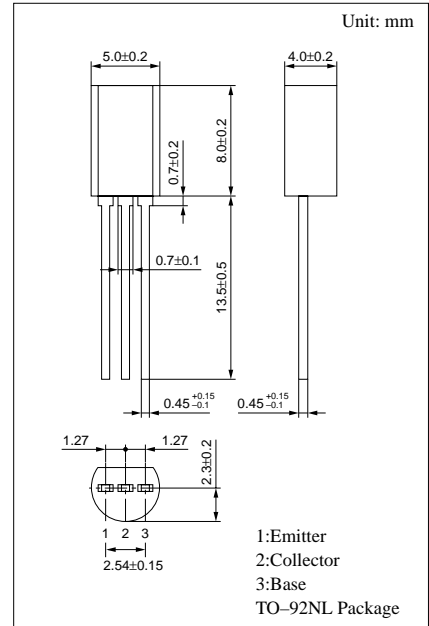

■ Electrical Characteristics (Ta=25°C)

Parameter	Symbol	Conditions	min	typ	max	Unit
Collector cutoff current	I_{CBO}	$V_{CB} = -12V, I_E = 0$			-2	μA
Collector to emitter voltage	V_{CEO}	$I_C = -100\mu A, I_B = 0$	-200			V
Emitter to base voltage	V_{EBO}	$I_E = -1\mu A, I_C = 0$	-5			V
Forward current transfer ratio	h_{FE}^*	$V_{CE} = -10V, I_C = -5mA$	60		220	
Collector to emitter saturation voltage	$V_{CE(sat)}$	$I_C = -50mA, I_B = -5mA$			-1.5	V
Transition frequency	f_T	$V_{CB} = -10V, I_E = 10mA, f = 200MHz$	50	80		MHz
Collector output capacitance	C_{ob}	$V_{CB} = -10V, I_E = 0, f = 1MHz$		5	10	pF

* h_{FE} Rank classification

Rank	Q	R
h_{FE}	60 ~ 150	100 ~ 220

$P_C - T_a$

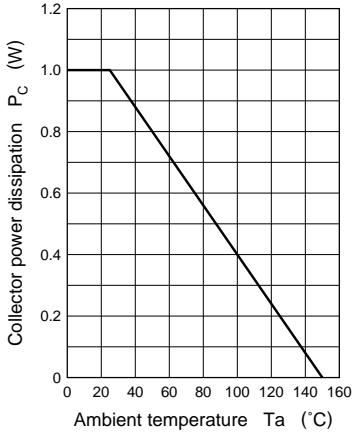

$I_C - V_{CE}$

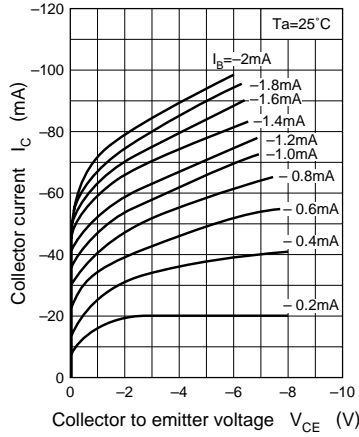

$I_C - I_B$

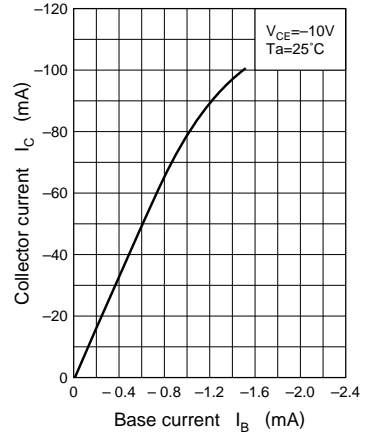

$I_B - V_{BE}$

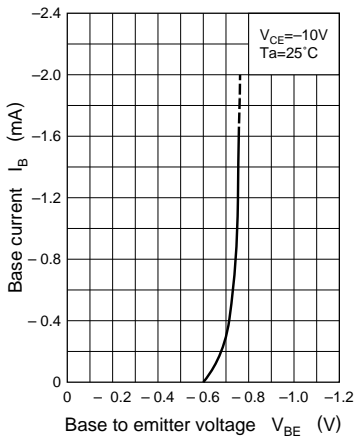

$I_C - V_{BE}$

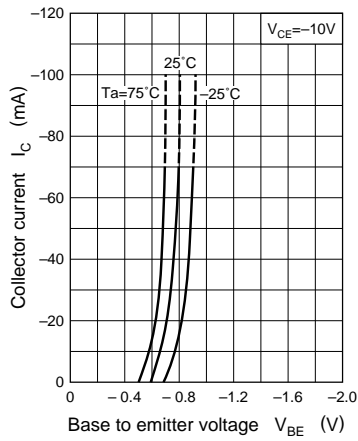

$V_{CE(sat)} - I_C$

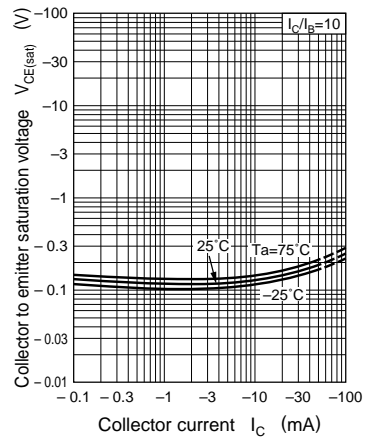

$h_{FE} - I_C$

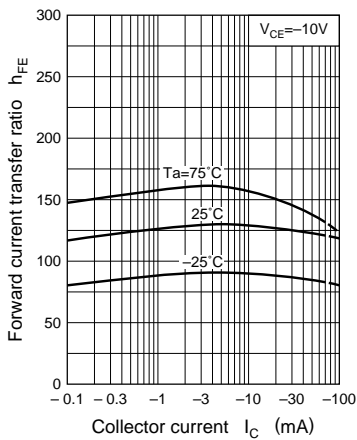

$f_T - I_E$

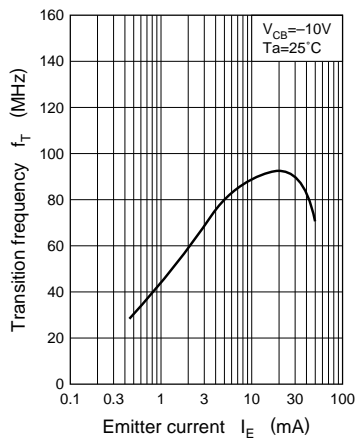

$C_{ob} - V_{CB}$

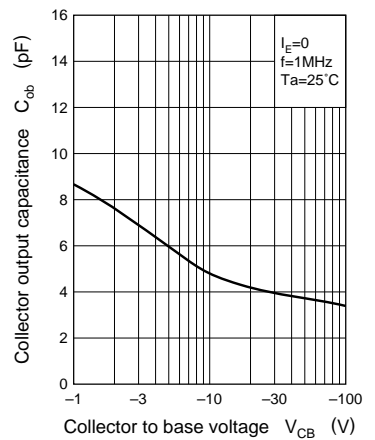

$I_{EBO} - T_a$

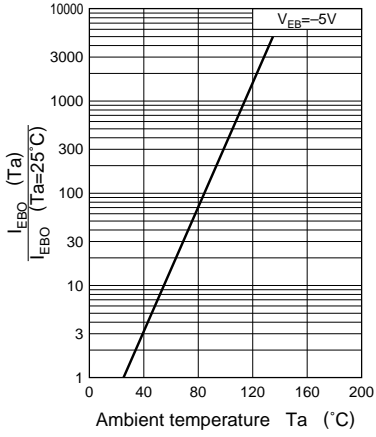

$I_{CBO} - T_a$

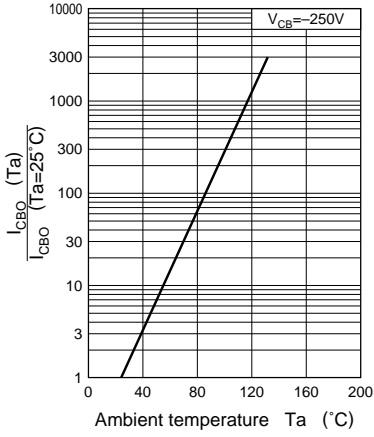

Area of safe operation (ASO)

