



2SB1260

PNP SILICON TRANSISTOR

POWER TRANSISTOR

DESCRIPTION

The UTC 2SB1260 is a epitaxial planar type PNP silicon transistor.

FEATURES

*High breakdown voltage and high current.

$BV_{CEO} = -80V, I_C = -1A$

*Good h_{FE} linearity.

*Low $V_{CE(SAT)}$

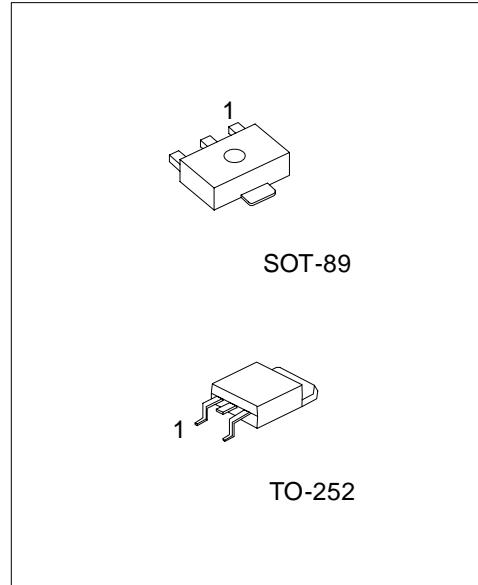

*Pb-free plating product number: 2SB1260L

www.DataSheet4U.com

ORDERING INFORMATION

Order Number		Package	Pin Assignment			Packing
Normal	Lead Free Plating		1	2	3	
2SB1260-x-AB3-R	2SB1260L-x-AB3-R	SOT-89	B	C	E	Tape Reel
2SB1260-x-TN3-R	2SB1260L-x-TN3-R	TO-252	B	C	E	Tape Reel
2SB1260-x-TN3-T	2SB1260L-x-TN3-T	TO-252	B	C	E	Tube

<p>2SB1260L-x-AB3-R</p> <p>(1)Packing Type (2)Package Type (3)Rank (4)Lead Plating</p>	<p>(1) B: Tape Box, K: Bulk, R: Tape Reel (2) AB3: SOT-89, TN3: TO-252 (3) refer to Classification of h_{FE} (4) L: Lead Free Plating, Blank: Pb/Sn</p>
--	--

■ ABSOLUTE MAXIMUM RATINGS (Ta = 25 °C)

PARAMETER	SYMBOL	RATINGS	UNIT
Collector -Base Voltage	V _{CBO}	-80	V
Collector -Emitter Voltage	V _{CEO}	-80	V
Emitter -Base Voltage	V _{EBO}	-5	V
Peak Collector Current (single pulse, Pw=100ms)	I _{CM}	-2	A
DC Collector Current	I _C	-1	A
Power Dissipation	SOT-89	0.5	W
	TO-252	1.9	W
Operating Temperature	T _J	+150	
Storage Temperature	T _{STG}	-40 ~ +150	

Note 1. Printed circuit board, 1.7mm thick, collector copper plating 100mm² or larger.

2. Absolute maximum ratings are those values beyond which the device could be permanently damaged.

Absolute maximum ratings are stress ratings only and functional device operation is not implied.

■ ELECTRICAL CHARACTERISTICS (Ta= 25 °C, unless otherwise specified)

PARAMETER	SYMBOL	TEST CONDITIONS	MIN	TYP	MAX	UNIT
Collector Base Breakdown Voltage	BV _{CBO}	I _C = -50 μA	-80			V
Collector Emitter Breakdown Voltage	BV _{CEO}	I _C = -1mA	-80			V
Emitter Base Breakdown Voltage	BV _{EBO}	I _E = -50 μA	-5			V
Collector Cut-Off Current	I _{CBO}	V _{CB} =-60V			-1	μA
Emitter Cut-Off Current	I _{EBO}	V _{EB} =-4V			-1	μA
DC Current Gain(Note 1)	h _{FE}	V _{CE} =-3V, I _{OUT} =-0.1A	82		390	
Collector-Emitter Saturation Voltage	V _{CE(SAT)}	I _C =-500mA, I _B =-50mA			-0.4	V
Transition Frequency	f _T	V _{CE} = -5V, I _E =50mA, f=30MHz		100		MHz
Output Capacitance	C _{ob}	V _{CB} =-10V, I _E =0, f=1MHz		25		pF

Note 1: Pulse test: P_w<300μs, Duty Cycle<2%

■ CLASSIFICATION OF h_{FE}

RANK	P	Q	R
RANGE	82 ~ 180	120 ~ 270	180 ~ 390

TYPICAL CHARACTERISTICS

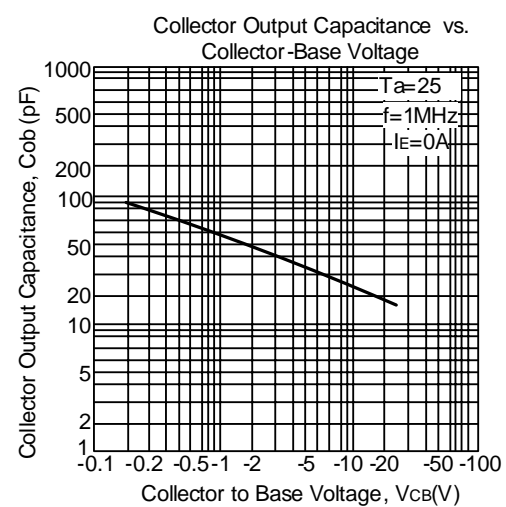
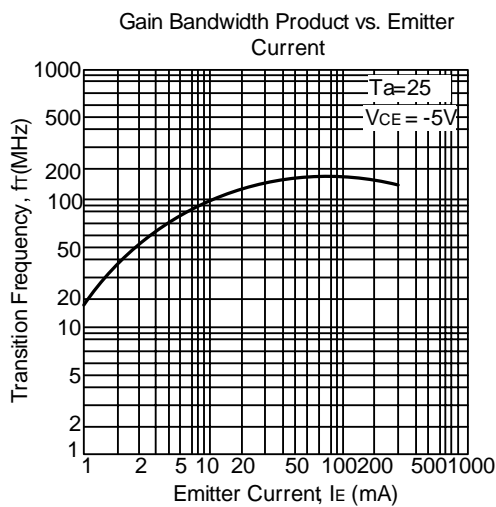
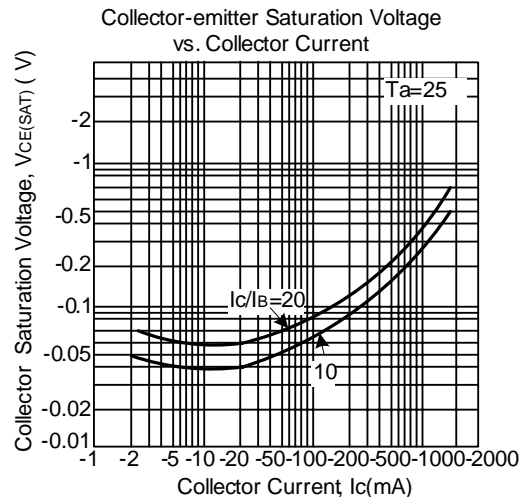
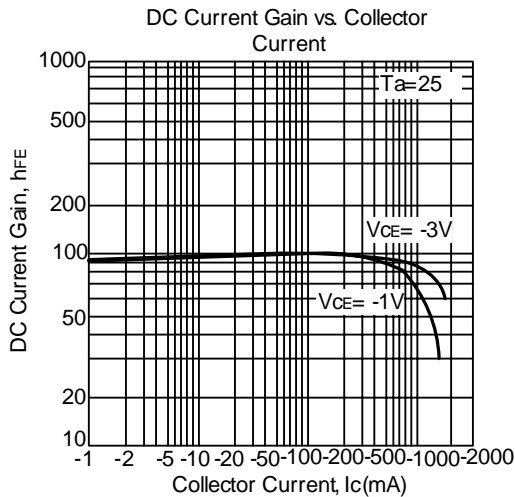
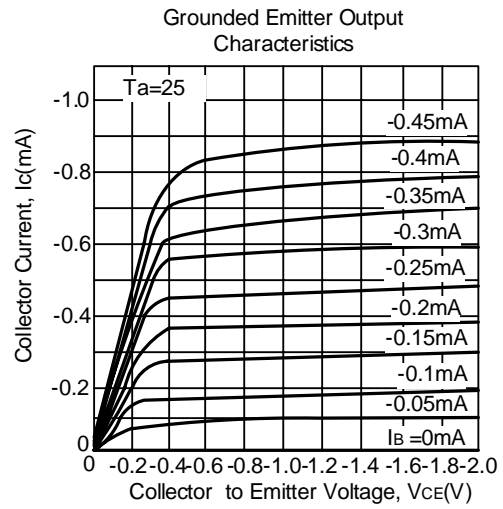
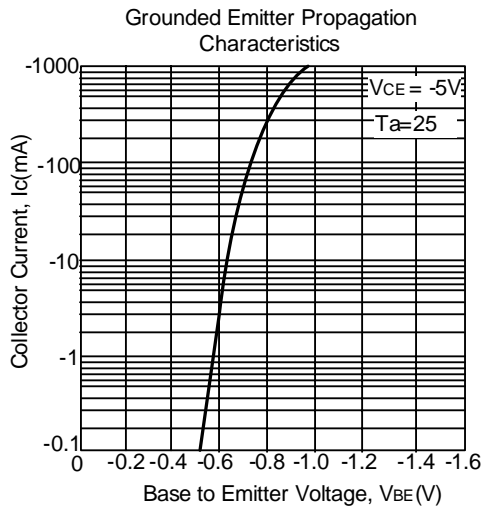

■ TYPICAL CHARACTERISTICS(Cont.)

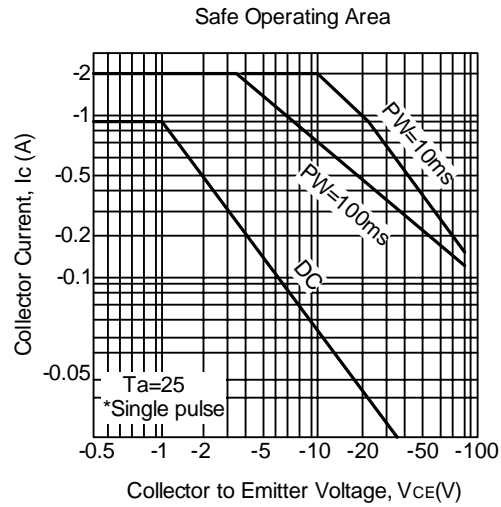
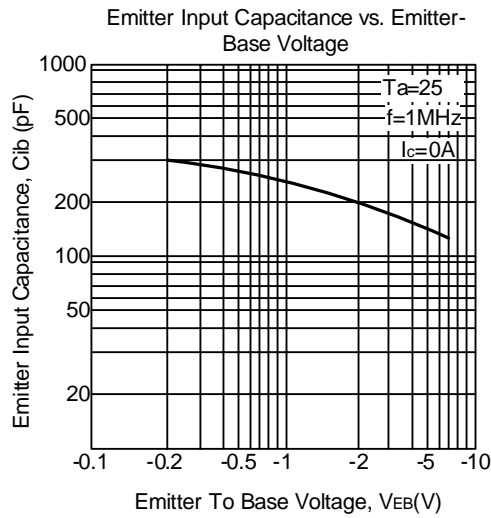

UTC assumes no responsibility for equipment failures that result from using products at values that exceed, even momentarily, rated values (such as maximum ratings, operating condition ranges, or other parameters) listed in products specifications of any and all UTC products described or contained herein. UTC products are not designed for use in life support appliances, devices or systems where malfunction of these products can be reasonably expected to result in personal injury. Reproduction in whole or in part is prohibited without the prior written consent of the copyright owner. The information presented in this document does not form part of any quotation or contract, is believed to be accurate and reliable and may be changed without notice.