



Micro Commercial Components



Micro Commercial Components  
20736 Marilla Street Chatsworth  
CA 91311  
Phone: (818) 701-4933  
Fax: (818) 701-4939

**2SB1386-P**  
**2SB1386-Q**  
**2SB1386-R**

## Features

- Low Collector Saturation Voltage
- Excellent current-to-gain characteristics
- Lead Free Finish/RoHS Compliant ("P" Suffix designates RoHS Compliant. See ordering information)
- Epoxy meets UL 94 V-0 flammability rating
- Moisture Sensitivity Level 1
- Halogen free available upon request by adding suffix "-HF"

## Maximum Ratings

Symbol	Rating	Rating	Unit
$V_{CE0}$	Collector-Emitter Voltage	-20	V
$V_{CBO}$	Collector-Base Voltage	-30	V
$V_{EBO}$	Emitter-Base Voltage	-6.0	V
$I_C$	Collector Current	-5.0	A
$I_{CP}$	Pulsed Collector Current	-10	A
$P_C$	Collector power dissipation	0.5	W
$T_J$	Junction Temperature	150	°C
$T_{STG}$	Storage Temperature	-55 to +150	°C

## Electrical Characteristics @ 25°C Unless Otherwise Specified

Symbol	Parameter	Min	Typ	Max	Units
$V_{(BR)CBO}$	Collector-base Breakdown Voltage ( $I_C = -50\mu\text{Adc}$ , $I_E = 0$ )	-30	---	---	Vdc
$V_{(BR)CEO}$	Collector-Emitter Breakdown Voltage ( $I_C = -1\text{mAdc}$ , $I_B = 0$ )	-20	---	---	Vdc
$V_{(BR)EBO}$	Emitter-base Breakdown Voltage ( $I_E = -50\mu\text{Adc}$ , $I_C = 0$ )	-6	---	---	Vdc
$I_{CBO}$	Collector-Base Cutoff Current ( $V_{CB} = -20\text{Vdc}$ , $I_E = 0$ )	---	---	-0.5	$\mu\text{Adc}$
$I_{EBO}$	Emitter-Base Cutoff Current ( $V_{EB} = -5\text{Vdc}$ , $I_C = 0$ )	---	---	-0.5	$\mu\text{Adc}$
$h_{FE(1)}$	DC Current Gain ( $I_C = -0.5\text{Adc}$ , $V_{CE} = -2.0\text{Vdc}$ )	82	---	390	---
$V_{CE(sat)}$	Collector-Emitter Saturation Voltage ( $I_C = -4\text{Adc}$ , $I_B = -0.1\text{Adc}$ )	---	---	-1.0	Vdc
$f_T$	Transition Frequency ( $V_{CE} = -6\text{Vdc}$ , $I_C = -50\text{mAdc}$ , $f = 30\text{MHz}$ )	---	120	---	MHz
$C_{ob}$	Collector output capacitance ( $V_{CB} = -20\text{Vdc}$ , $I_E = 0$ , $f = 1.0\text{MHz}$ )	---	60	---	pF

## CLASSIFICATION OF $h_{FE(1)}$

Rank	P	Q	R
Range	82-180	120-270	180-390
Marking	BHP	BHQ	BHR

## PNP Silicon Epitaxial Transistors

## SOT-89

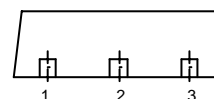
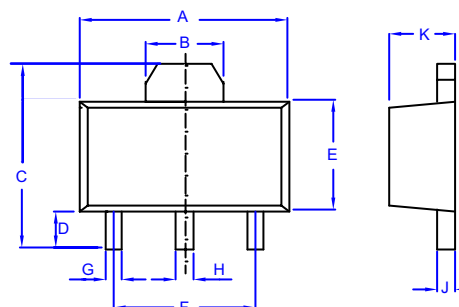

1. Emitter
2. Collector
3. Base

DIM	DIMENSIONS				NOTES
	INCHES		MM		
	MIN	MAX	MIN	MAX	
A	.173	.181	4.39	4.60	
B	.061	----	1.55	----	REF.
C	.154	.165	3.91	4.25	
D	.031	.039	0.80	1.00	
E	.092	.100	2.34	2.54	
F	.118	----	3.00	----	TYP
G	.013	.019	0.33	0.48	
H	.015	.021	0.38	0.53	
J	.015	.016	0.38	0.41	
K	.055	.063	1.40	1.60	

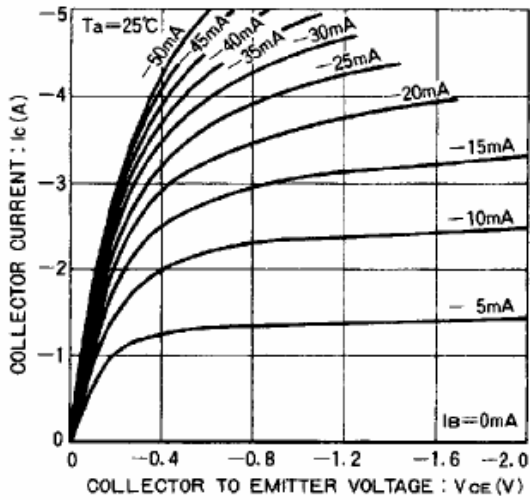

Figure 1

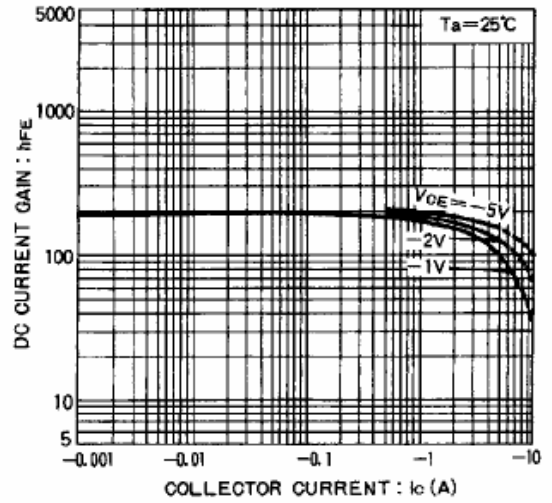

Figure 2

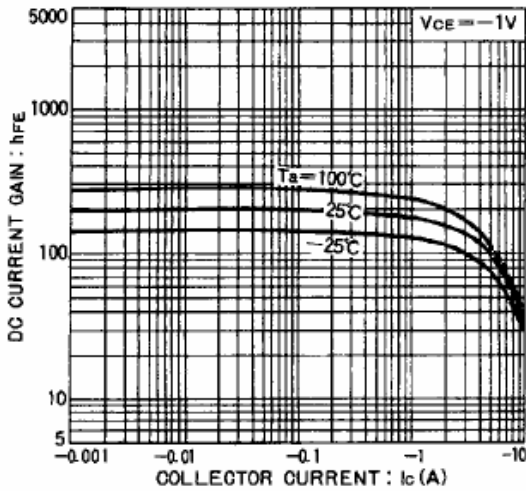

Figure 3

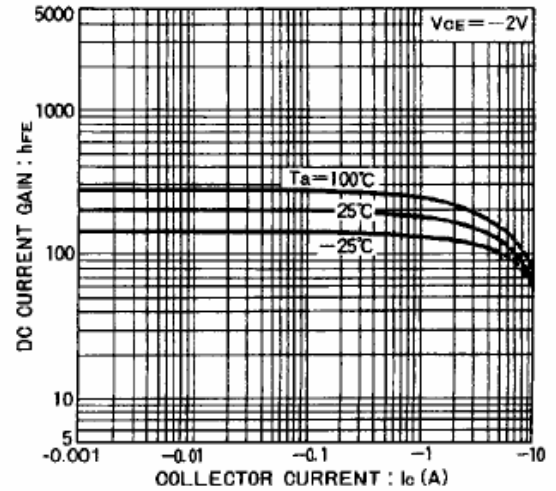

Figure 4

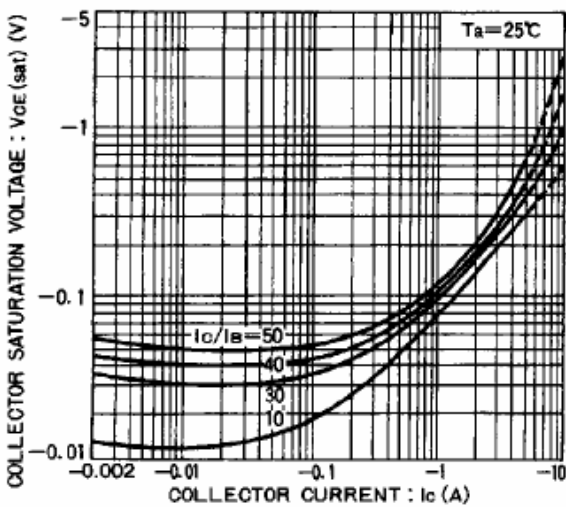

Figure 5

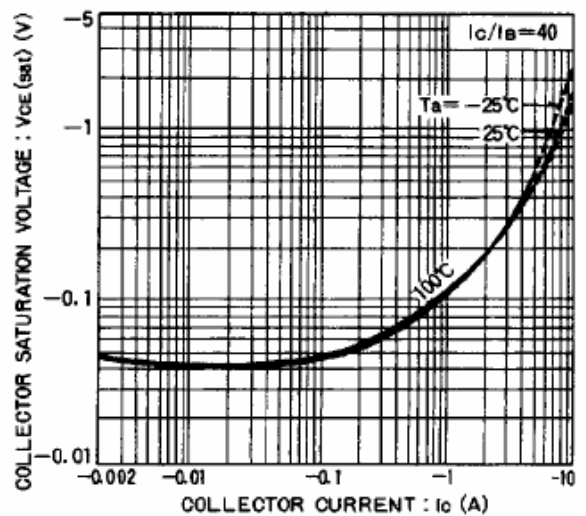
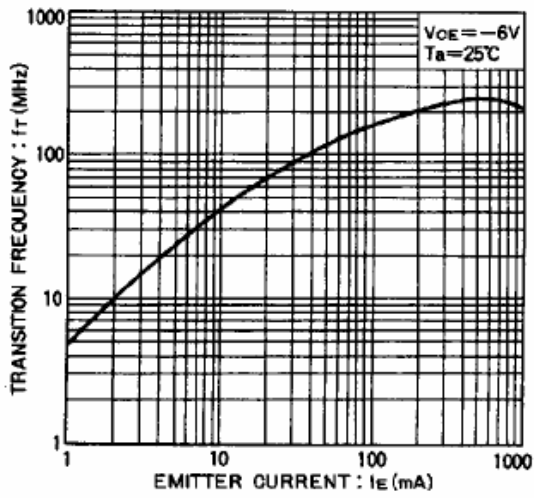
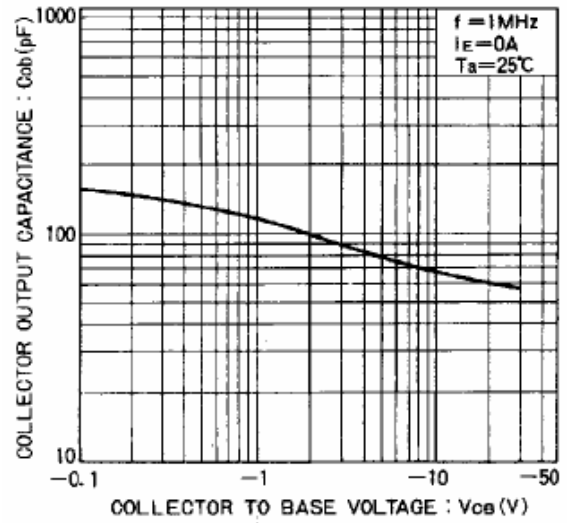

Figure 6



**Figure 7**



**Figure 8**

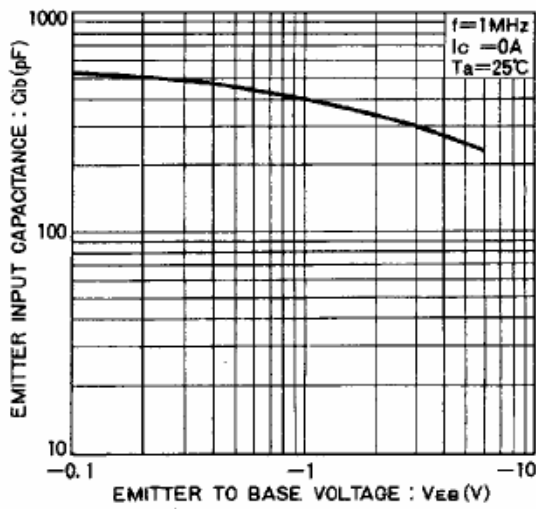

**Figure 9**



Micro Commercial Components

### Ordering Information :

Device	Packing
Part Number-TP	Tape&Reel; 1Kpcs/Reel

Note : Adding "-HF" suffix for halogen free, eg. Part Number-TP-HF

#### \*\*\*IMPORTANT NOTICE\*\*\*

**Micro Commercial Components Corp.** reserves the right to make changes without further notice to any product herein to make corrections, modifications, enhancements, improvements, or other changes. **Micro Commercial Components Corp.** does not assume any liability arising out of the application or use of any product described herein; neither does it convey any license under its patent rights, nor the rights of others. The user of products in such applications shall assume all risks of such use and will agree to hold **Micro Commercial Components Corp.** and all the companies whose products are represented on our website, harmless against all damages.

#### \*\*\*LIFE SUPPORT\*\*\*

MCC's products are not authorized for use as critical components in life support devices or systems without the express written approval of Micro Commercial Components Corporation.

#### \*\*\*CUSTOMER AWARENESS\*\*\*

Counterfeiting of semiconductor parts is a growing problem in the industry. Micro Commercial Components (MCC) is taking strong measures to protect ourselves and our customers from the proliferation of counterfeit parts. MCC strongly encourages customers to purchase MCC parts either directly from MCC or from Authorized MCC Distributors who are listed by country on our web page cited below. Products customers buy either from MCC directly or from Authorized MCC Distributors are genuine parts, have full traceability, meet MCC's quality standards for handling and storage. **MCC will not provide any warranty coverage or other assistance for parts bought from Unauthorized Sources.** MCC is committed to combat this global problem and encourage our customers to do their part in stopping this practice by buying direct or from authorized distributors.

[www.mccsemi.com](http://www.mccsemi.com)