

2SB1603, 2SB1603A

Silicon PNP epitaxial planar type

For low-voltage switching

Features

- Low collector to emitter saturation voltage $V_{CE(sat)}$
- High-speed switching
- Full-pack package with outstanding insulation, which can be installed to the heat sink with one screw

Absolute Maximum Ratings ($T_C=25^\circ\text{C}$)

Parameter	Symbol	Rated	Unit
Collector to base voltage	V_{CBO}	-40	V
2SB1603A		-50	
Collector to emitter voltage	V_{CEO}	-20	V
2SB1603A		-40	
Emitter to base voltage	V_{EBO}	-5	V
Peak collector current	I_{CP}	-8	A
Collector current	I_C	-4	A
Collector power dissipation	P_C	25	W
$T_C=25^\circ\text{C}$ $T_a=25^\circ\text{C}$		2	
Junction temperature	T_j	150	$^\circ\text{C}$
Storage temperature	T_{stg}	-55 to +150	$^\circ\text{C}$

Electrical Characteristics ($T_C=25^\circ\text{C}$)

Parameter	Symbol	Conditions	min	typ	max	Unit
Collector cutoff current	I_{CBO}	$V_{CB} = -40\text{V}, I_E = 0$			-50	μA
Emitter cutoff current	I_{EBO}	$V_{EB} = -5\text{V}, I_C = 0$			-50	μA
Collector to emitter voltage	V_{CEO}	$I_C = -10\text{mA}, I_B = 0$	-20			V
			-40			
Forward current transfer ratio	h_{FE1}	$V_{CE} = -2\text{V}, I_C = -0.1\text{A}$	45			
	h_{FE2}^*	$V_{CE} = -2\text{V}, I_C = -1\text{A}$	90		260	
Collector to emitter saturation voltage	$V_{CE(sat)}$	$I_C = -2\text{A}, I_B = -0.1\text{A}$			-0.5	V
Base to emitter saturation voltage	$V_{BE(sat)}$	$I_C = -2\text{A}, I_B = -0.1\text{A}$			-1.5	V
Transition frequency	f_T	$V_{CE} = -5\text{V}, I_C = -0.5\text{A}, f = 10\text{MHz}$		150		MHz
Turn-on time	t_{on}	$I_C = -2\text{A}, I_{B1} = -0.2\text{A}, I_{B2} = 0.2\text{A}$		0.3		μs
Storage time	t_{stg}			0.4		μs
Fall time	t_f			0.1		μs

* h_{FE2} Rank classification

Rank	Q	P
h_{FE2}	90 to 180	130 to 260

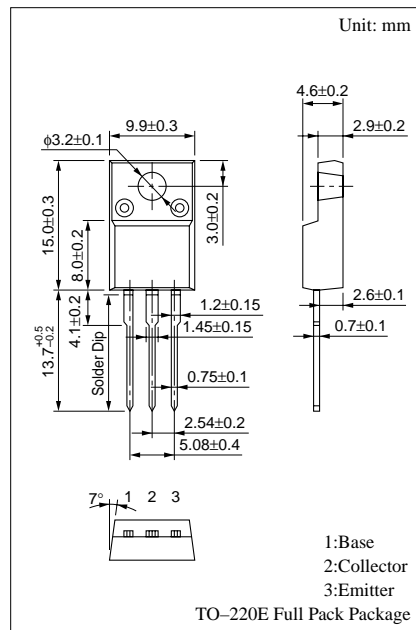

$P_C - T_a$

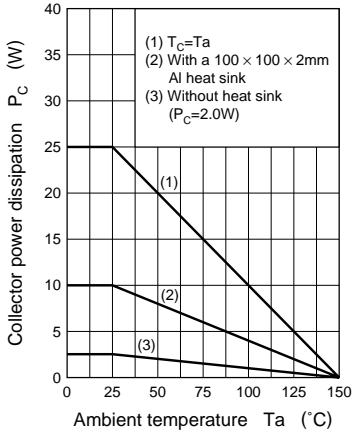

$I_C - V_{CE}$

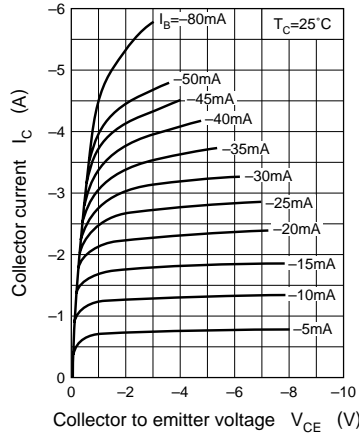

$V_{CE(sat)} - I_C$

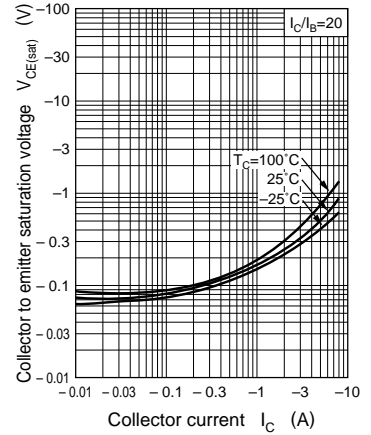

$V_{BE(sat)} - I_C$

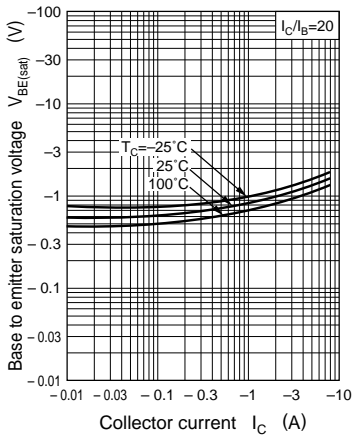

$h_{FE} - I_C$

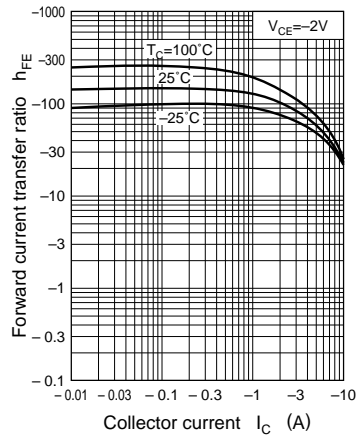

$f_T - I_C$

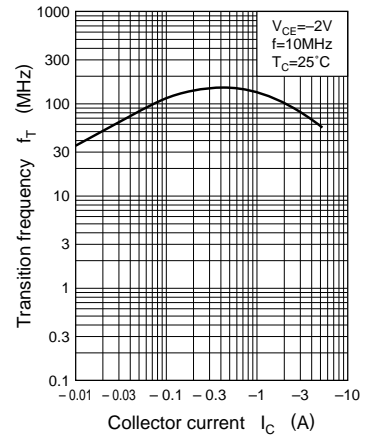

$t_{on}, t_{stg}, t_f - I_C$

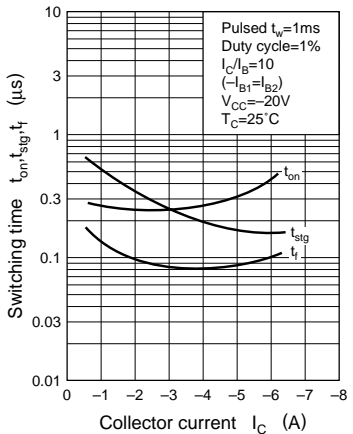

Area of safe operation (ASO)

