



ON Semiconductor®

# ON Semiconductor DATA SHEET

## 2SB631, 631K/ 2SD600, 600K

PNP/NPN Epitaxial Planar Silicon Transistors  
**100V/120V, 1A Low-Frequency  
Power Amplifier Applications**

### Features

- High breakdown voltage  $V_{CEO}$  100/120V, High current 1A.
- Low saturation voltage, excellent  $h_{FE}$  linearity.

### Package Dimensions

unit:mm  
2009B

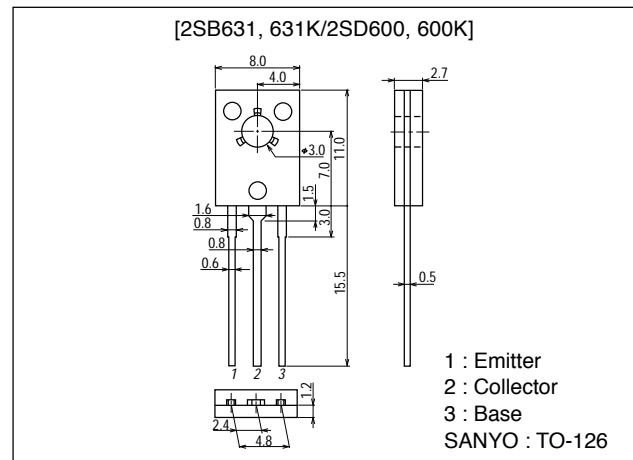

( ) : 2SB631, 631K

### Specifications

Absolute Maximum Ratings at  $T_a = 25^\circ\text{C}$

Parameter	Symbol	Conditions	2SB631, D600	2SB631K, D600K	Unit
Collector-to-Base Voltage	$V_{CBO}$		(-)100	(-)120	V
Collector-to-Emitter Voltage	$V_{CEO}$		(-)100	(-)120	V
Emitter-to-Base Voltage	$V_{EBO}$			(-)5	V
Collector Current	$I_C$			(-)1	A
Collector Current (Pulse)	$I_{CP}$			(-)2	A
Collector Dissipation	$P_C$			1	W
		$T_c=25^\circ\text{C}$		8	W
Junction Temperature	$T_j$			150	$^\circ\text{C}$
Storage Temperature	$T_{stg}$			-55 to +150	$^\circ\text{C}$

Electrical Characteristics at  $T_a = 25^\circ\text{C}$

Parameter	Symbol	Conditions	Ratings			Unit
			min	typ	max	
Collector-to-Base Breakdown Voltage	$V_{(BR)CBO}$	$I_C=(-)10\mu\text{A}, I_E=0$	B631, D600	(-)100		V
			B631K, D600K	(-)120		V
Collector-to-Emitter Breakdown Voltage	$V_{(BR)CEO}$	$I_C=(-)1\text{mA}, R_{BE}=\infty$	B631, D600	(-)100		V
			B631K, D600K	(-)120		V
Emitter-to-Base Breakdown Voltage	$V_{(BR)EBO}$	$I_E=(-)10\mu\text{A}, I_C=0$	(-)5		V	
Collector Cutoff Current	$I_{CBO}$	$V_{CB}=(-)50\text{V}, I_E=0$			(-)1	$\mu\text{A}$
Emitter Cutoff Current	$I_{EBO}$	$V_{EB}=(-)4\text{V}, I_C=0$			(-)1	$\mu\text{A}$

Continued on next page.

# 2SB631, 631K/2SD600, 600K

Continued on next page.

Parameter	Symbol	Conditions	Ratings			Unit
			min	typ	max	
DC Current Gain	$h_{FE1}$	$V_{CE}=(-)5V, I_C=(-)50mA$	60*		320*	
	$h_{FE2}$	$V_{CE}=(-)5V, I_C=(-)500mA$	20			
Gain-Bandwidth Product	$f_T$	$V_{CE}=(-)10V, I_C=(-)50mA$		(110) 130		MHz MHz
Output Capacitance	$C_{ob}$	$V_{CB}=(-)10V, f=1MHz$		(30)20		pF
Collector-to-Emitter Saturation Voltage	$V_{CE(sat)}$	$I_C=(-)500mA, I_B=(-)50mA$		(-)0.15	(-)0.4	V
Base-to-Emitter Saturation Voltage	$V_{BE(sat)}$	$I_C=(-)500mA, I_B=(-)50mA$		(-)0.85	(-)1.2	V
Fall Time	$t_f$	See specified Test Circuit		(80)		ns
				100		ns
Turn-OFF Time	$t_{off}$	See specified Test Circuit		(100)		ns
				500		ns
Storage Time	$t_{stg}$	See specified Test Circuit		(600)		ns
				700		ns

\* : The 2SB631/2SD600 are classified by 50mA  $h_{FE}$  as follows :

Rank	D	E	F
$h_{FE}$	60 to 120	100 to 200	160 to 320

## Switching Time Test Circuit

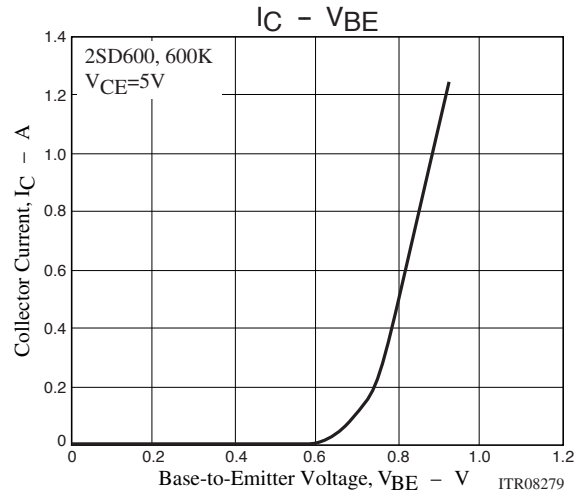
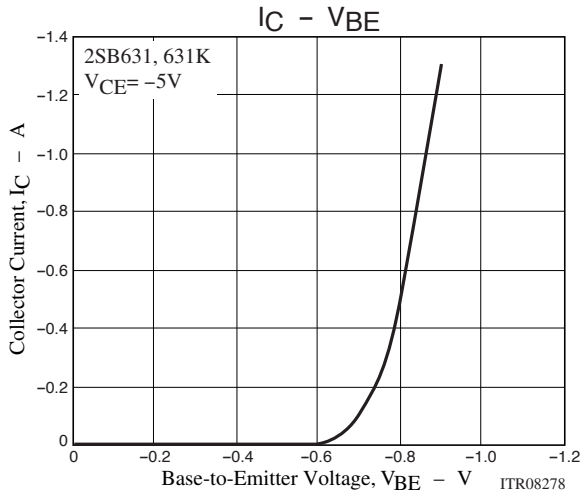
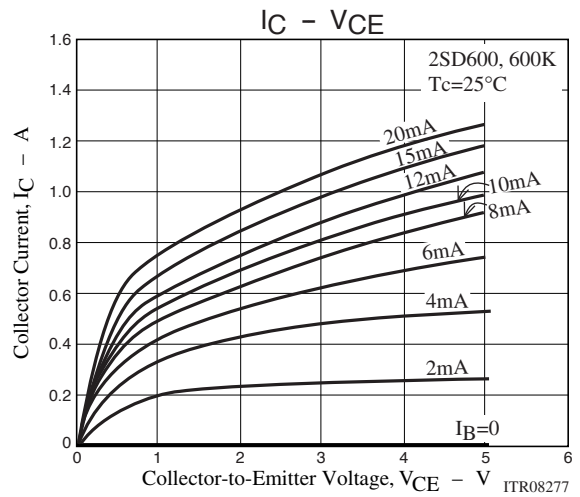
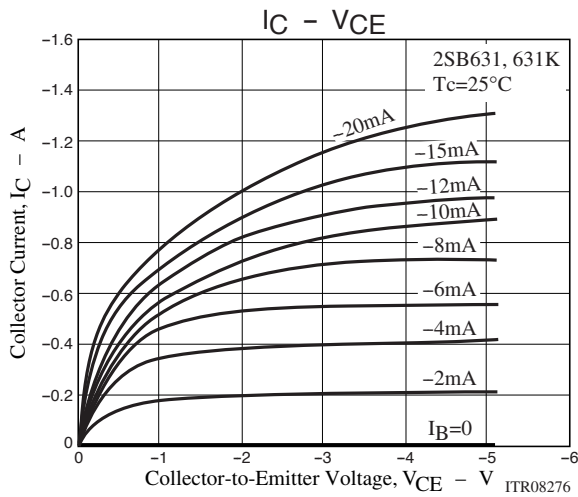
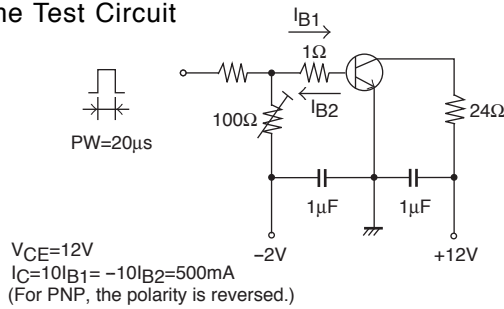

# 2SB631, 631K/2SD600, 600K

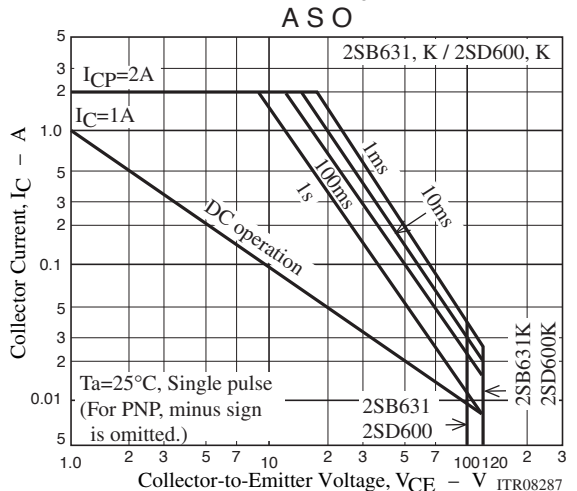
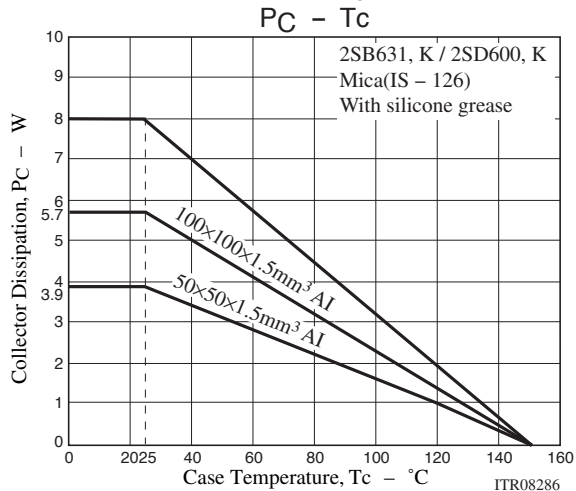
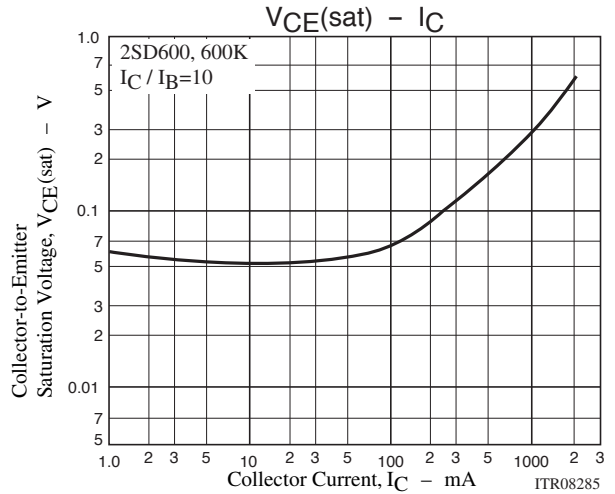
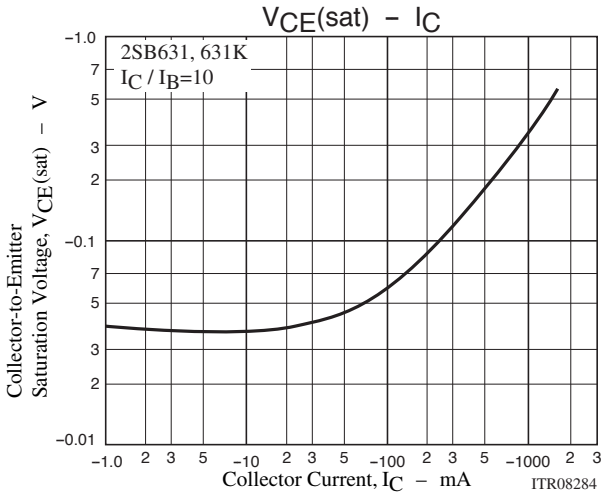
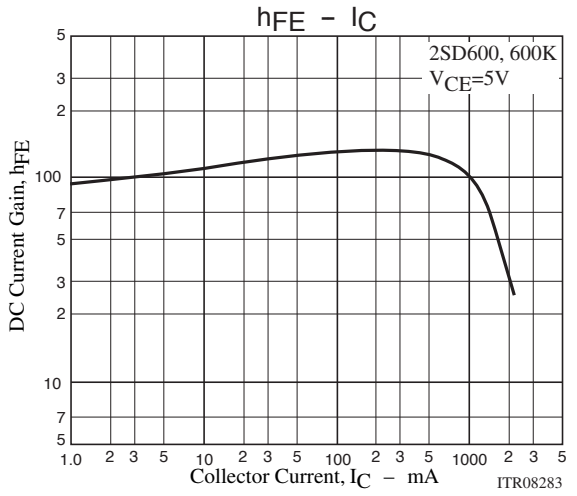
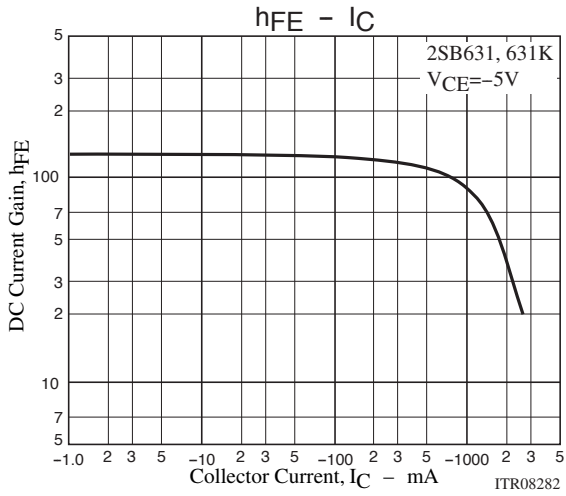
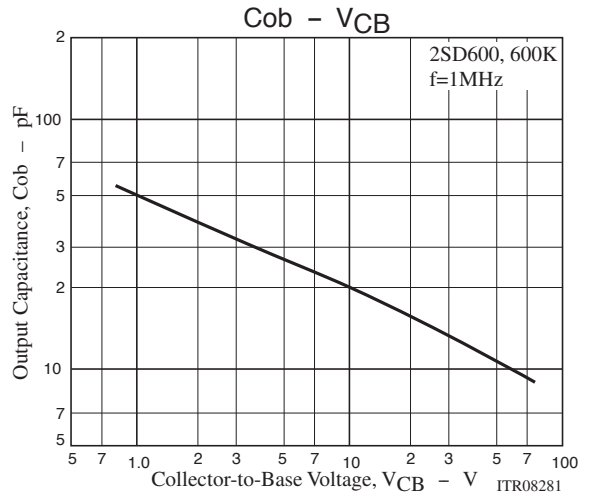
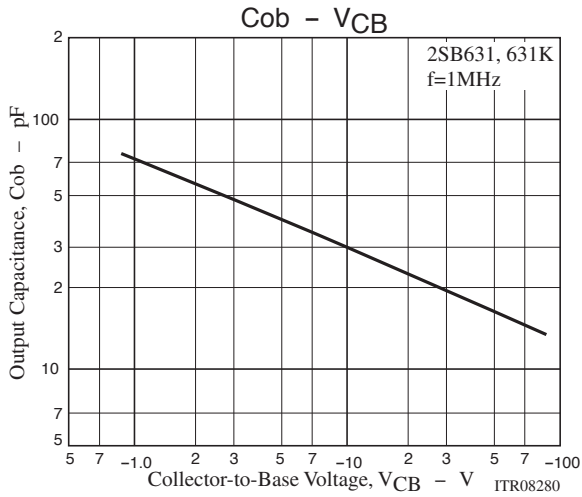

## 2SB631, 631K/2SD600, 600K

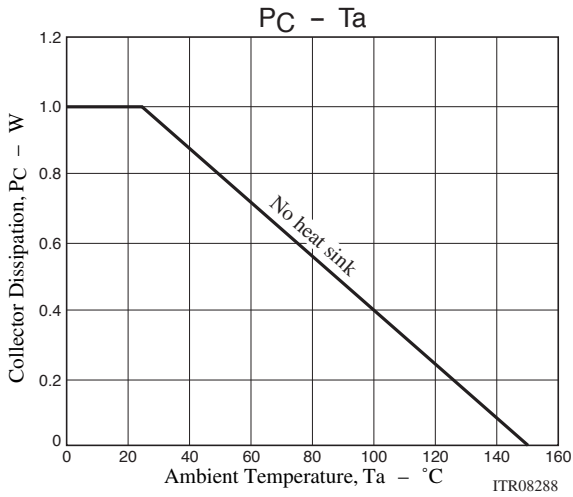

ON Semiconductor and the ON logo are registered trademarks of Semiconductor Components Industries, LLC (SCILLC). SCILLC reserves the right to make changes without further notice to any products herein. SCILLC makes no warranty, representation or guarantee regarding the suitability of its products for any particular purpose, nor does SCILLC assume any liability arising out of the application or use of any product or circuit, and specifically disclaims any and all liability, including without limitation special, consequential or incidental damages. SCILLC strives to supply high-quality high-reliability products and recommends adopting safety measures when designing equipment to avoid accidents or malfunctions. Such measures include but are not limited to protective circuits and error prevention circuits for safe design, redundant design, and structural design. "Typical" parameters which may be provided in SCILLC data sheets and/or specifications can and do vary in different applications and actual performance may vary over time. All operating parameters, including "Typicals," must be validated for each customer application by customer's technical experts. SCILLC shall not be held liable for any claim or suits with regard to a third party's intellectual property rights which has resulted from the use of the technical information and products mentioned above. SCILLC does not convey any license under its patent rights nor the rights of others. SCILLC products are not designed, intended, or authorized for use as components in systems intended for surgical implant into the body, or other applications intended to support or sustain life, or for any other application in which the failure of the SCILLC product could create a situation where personal injury or death may occur. Should Buyer purchase or use SCILLC products for any such unintended or unauthorized application, Buyer shall indemnify and hold SCILLC and its officers, employees, subsidiaries, affiliates, and distributors harmless against all claims, costs, damages, and expenses, and reasonable attorney fees arising out of, directly or indirectly, any claim of personal injury or death associated with such unintended or unauthorized use, even if such claim alleges that SCILLC was negligent regarding the design or manufacture of the part. SCILLC is an Equal Opportunity/Affirmative Action Employer. This literature is subject to all applicable copyright laws and is not for resale in any manner.

### PUBLICATION ORDERING INFORMATION

#### LITERATURE FULFILLMENT:

Literature Distribution Center for ON Semiconductor  
P.O. Box 5163, Denver, Colorado 80217 USA  
Phone: 303-675-2175 or 800-344-3860 Toll Free USA/Canada  
Fax: 303-675-2176 or 800-344-3867 Toll Free USA/Canada  
Email: [orderlit@onsemi.com](mailto:orderlit@onsemi.com)

N. American Technical Support: 800-282-9855 Toll Free  
USA/Canada.

Europe, Middle East and Africa Technical Support:  
Phone: 421 33 790 2910

Japan Customer Focus Center  
Phone: 81-3-5773-3850

ON Semiconductor Website: [www.onsemi.com](http://www.onsemi.com)

Order Literature: <http://www.onsemi.com/orderlit>

For additional information, please contact your local  
Sales Representative