

PNP Epitaxial Planar Transistors

 Lead(Pb)-Free

1. EMITTER
2. COLLECTOR
3. BASE

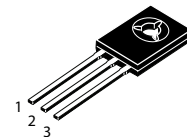

TO-18C

ABSOLUTE MAXIMUM RATINGS(TA=25°C)

Rating	Symbol	2SB649	2SB649A	Unit
Collector-Emitter Voltage	V_{CBO}	-180		V
Collector-Base Voltage	V_{CEO}	-120	-160	V
Emitter-Base Voltage	V_{EBO}	6.0		V
Collector Current	I_C	-1.5		A
Power Dissipation	P_D	1.0		W
Junction Temperature	T_j	+150		°C
Storage Temperature	T_{stg}	-55 to +150		°C

ELECTRICAL CHARACTERISTICS ($T_A=25^\circ\text{C}$ unless otherwise noted) (Continued)

Characteristics	Symbol	Min	Typ	Max	Unit
Collector-Emitter Breakdown Voltage $I_C = -1.0\text{mA}, I_E = 0$	$V_{(BR)CBO}$	-180	-	-	V
Collector-Base Breakdown Voltage $I_C = -10\text{mA}, I_B = 0$	$V_{(BR)CEO}$	-120 -160	-	-	V
Emitter-Base Breakdown Voltage $I_C = 0, I_E = -1.0\text{mA}$	$V_{(BR)EBO}$	-5.0	-	-	V
Collector Cutoff Current $V_{CB} = -160\text{V}, I_E = 0$	I_{CBO}	-	-	-10	μA
Emitter Cutoff Current $V_{EB} = -4.0\text{V}, I_C = 0$	I_{EBO}	-	-	-10	μA

ON CHARACTERISTICS

DC Current Gain $V_{CE} = -5.0\text{V}, I_C = -150\text{mA}$	$h_{FE(1)}$	60 60	-	320 200	-
$V_{CE} = -5.0\text{V}, I_C = -500\text{mA}$	$h_{FE(2)}$	30	-	-	-
Collector-Emitter Saturation Voltage $I_C = -500\text{mA}, I_B = -50\text{mA}$	$V_{CE(sat)}$	-	-	-1.0	V
Base-Emitter Voltage $V_{CE} = -5.0\text{V}, I_C = -150\text{mA}$	V_{BE}	-	-	-1.5	V
Transition frequency $V_{CE} = -5.0\text{V}, I_C = -150\text{mA}$	f_T	-	140	-	MHz
Collector Output Capacitance $V_{CB} = -10\text{V}, I_E = 0, f = 1\text{MHz}$	C_{ob}	-	27	-	pF

CLASSIFICATION OF $h_{FE(1)}$

Rank	B	C	D
Range	60-120	100-200	160-320

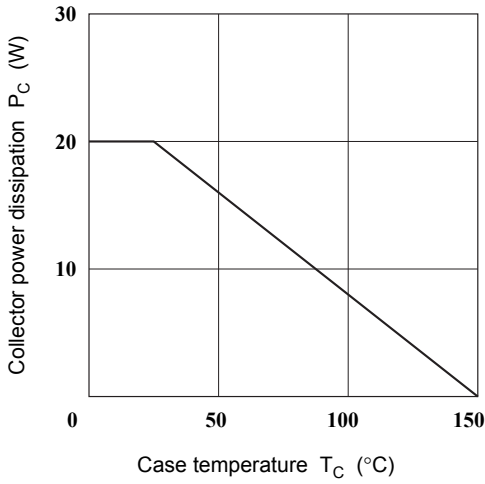

Fig.1 Maximum Collector Dissipation Curve

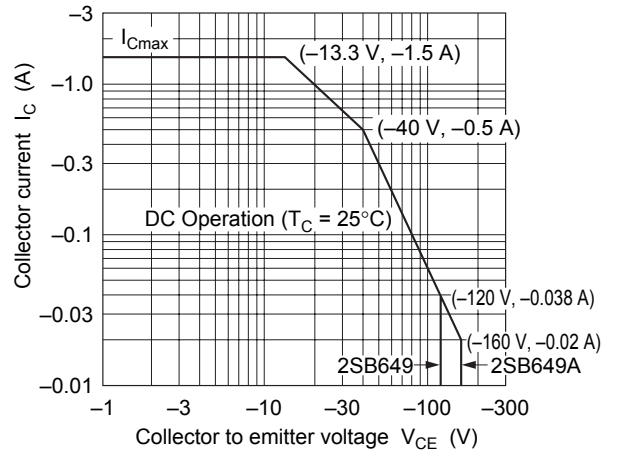

Fig.2 Area of Safe Operation

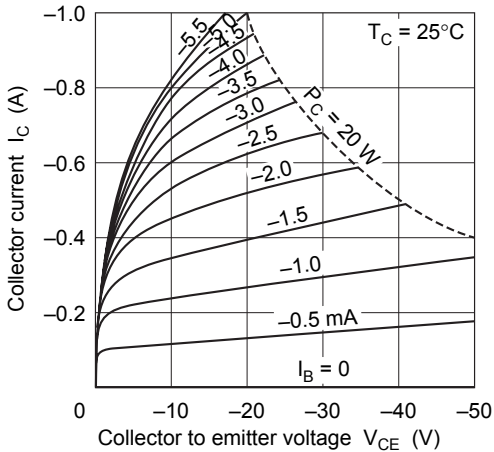

Fig.3 Typical Output Characteristics

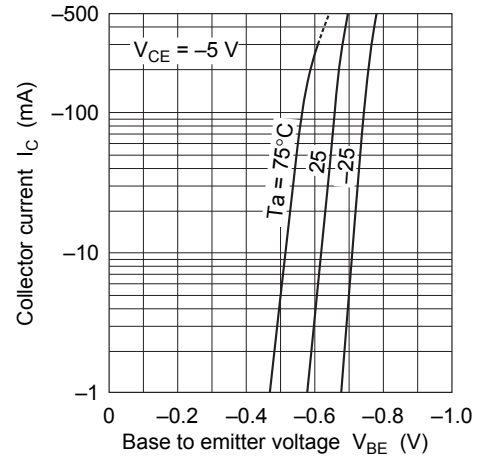

Fig.4 Typical Transfer Characteristics

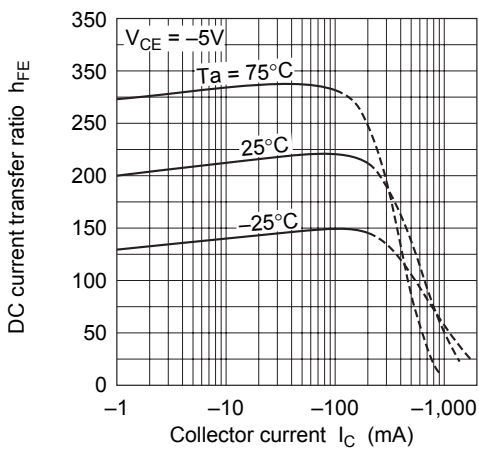

Fig.5 DC Current Transfer Ratio vs. Collector Current

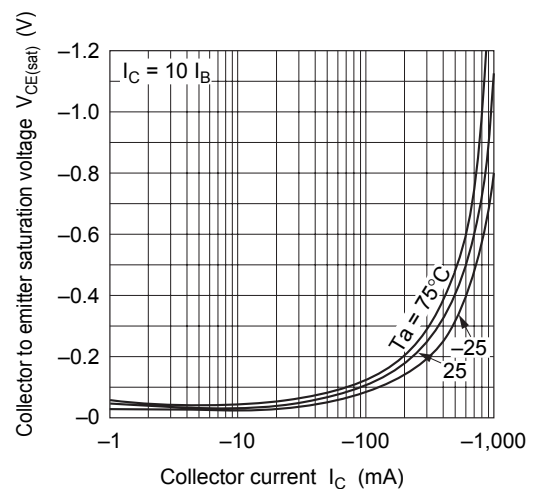

Fig.6 Collector to Emitter Saturation Voltage vs. Collector Current

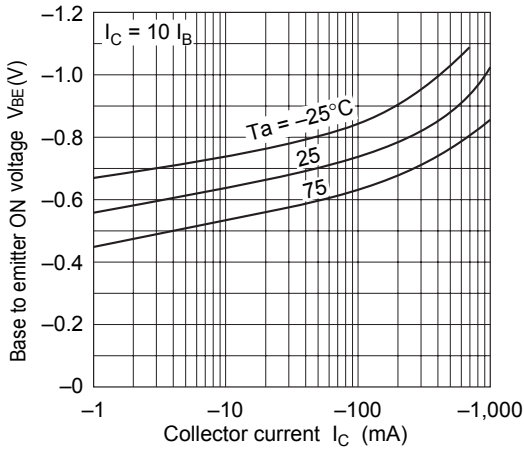

Fig.7 Base to Emitter Voltage vs. Collector Current

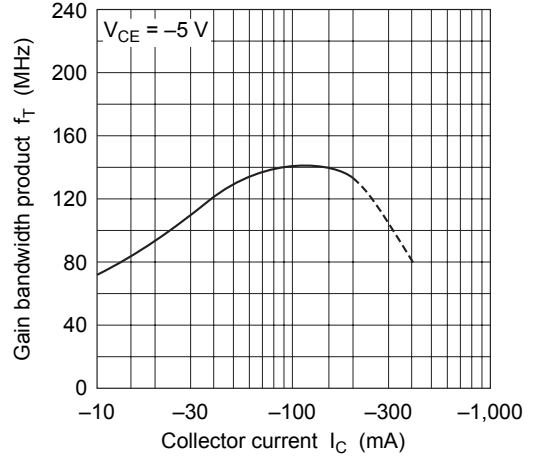

Fig.8 Gain Bandwidth Product vs. Collector Current

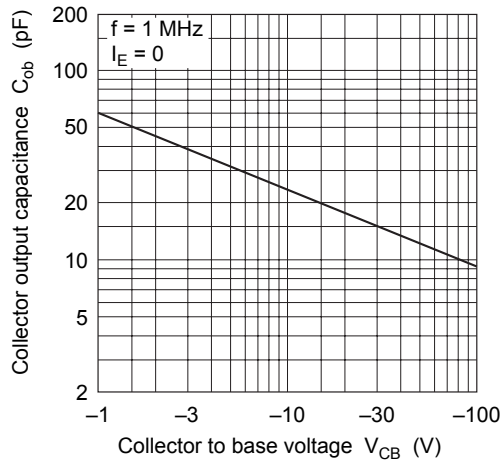
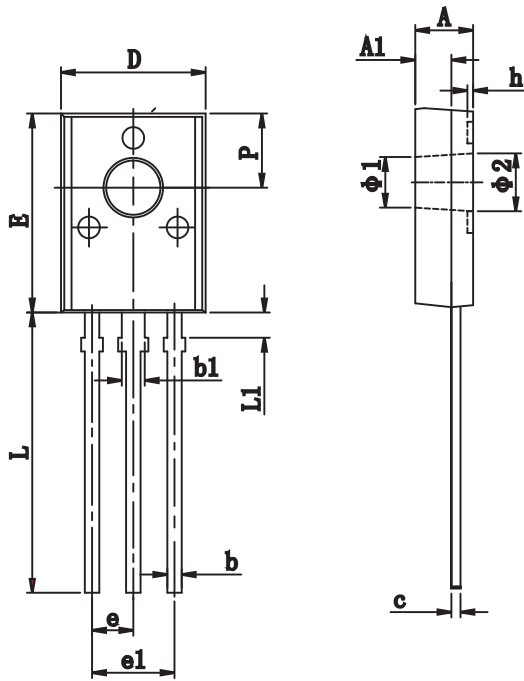

Fig.9 Collector Output Capacitance vs. Collector to Base Voltage

TO-126C Outline Dimensions

unit:mm



TO-126C		
Dim	Min	Max
A	3.000	3.400
A1	1.800	2.200
b	0.660	0.860
b1	1.170	1.370
c	0.450	0.600
D	7.800	8.200
E	10.800	11.200
e	2.280 TYP	
e1	4.460	4.660
L	15.100	15.500
L1	1.300	1.500
P	4.040	4.240
φ1	2.700	2.900
φ2	3.100	3.300