

NPN Silicon

- We declare that the material of product compliance with RoHS requirements.
Pb-Free package is available
 RoHS product for packing code suffix "G"
 Halogen free product for packing code suffix "H"

2SC2412KXLT1



SOT-23

ORDERING INFORMATION

Device	Marking	Shipping
2SC2412KQLT1	BQ	3000 Tape & Reel
2SC2412KRLT1	BR	3000 Tape & Reel
2SC2412KSLT1	G1F	3000 Tape & Reel

MAXIMUM RATINGS

Rating	Symbol	Value	Unit
Collector-Emitter Voltage	V_{CEO}	50	V
Collector-Base Voltage	V_{CBO}	60	V
Emitter-Base Voltage	V_{EBO}	7.0	V
Collector Current — Continuous	I_C	150	mAdc
Collector power dissipation	P_C	0.2	W
Junction temperature	T_j	150	°C
Storage temperature	T_{stg}	-55 ~ +150	°C

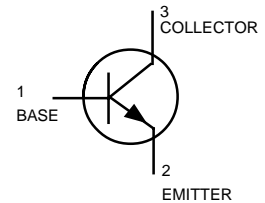

DEVICE MARKING

2SC2412KQLT1=BQ 2SC2412KRLT1=BR 2SC2412KSLT1=G1F

ELECTRICAL CHARACTERISTICS ($T_A = 25^\circ\text{C}$ unless otherwise noted.)

Characteristic	Symbol	Min	Typ	Max	Unit
Collector-Emitter Breakdown Voltage ($I_C = 1\text{ mA}$)	$V_{(BR)CEO}$	50	—	—	V
Emitter-Base Breakdown Voltage ($I_E = 50\ \mu\text{A}$)	$V_{(BR)EBO}$	7	—	—	V
Collector-Base Breakdown Voltage ($I_C = 50\ \mu\text{A}$)	$V_{(BR)CBO}$	60	—	—	V
Collector Cutoff Current ($V_{CB} = 60\text{ V}$)	I_{CBO}	—	—	0.1	μA
Emitter cutoff current ($V_{EB} = 7\text{ V}$)	I_{EBO}	—	—	0.1	μA
Collector-emitter saturation voltage ($I_C / I_B = 50\text{ mA} / 5\text{ mA}$)	$V_{CE(sat)}$	—	—	0.4	V
DC current transfer ratio ($V_{CE} = 6\text{ V}, I_C = 1\text{ mA}$)	h_{FE}	120	—	560	—
Transition frequency ($V_{CE} = 12\text{ V}, I_E = -2\text{ mA}, f = 30\text{ MHz}$)	f_T	—	180	—	MHz
Output capacitance ($V_{CB} = 12\text{ V}, I_E = 0\text{ A}, f = 1\text{ MHz}$)	C_{ob}	—	2.0	3.5	pF

h_{FE} values are classified as follows:

*	Q	R	S
h_{FE}	120~270	180~390	270~560

Fig.1 Grounded emitter propagation characteristics

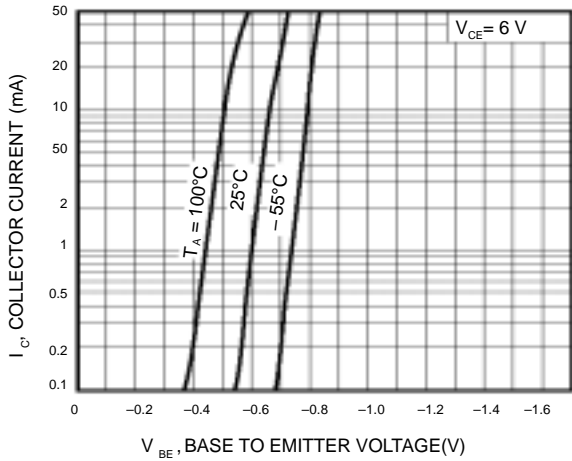

Fig.2 Grounded emitter output characteristics(I)

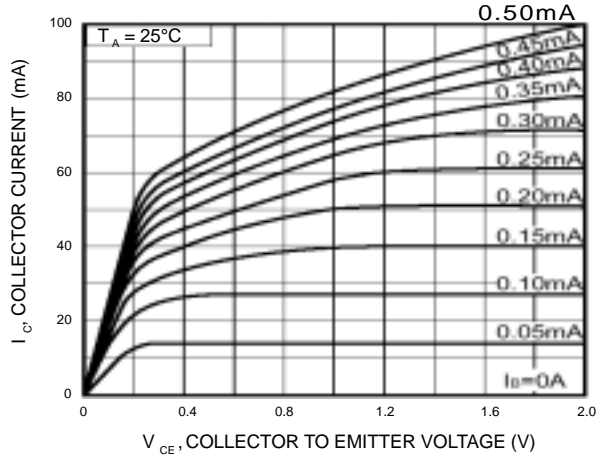

Fig.3 Grounded emitter output characteristics(II)

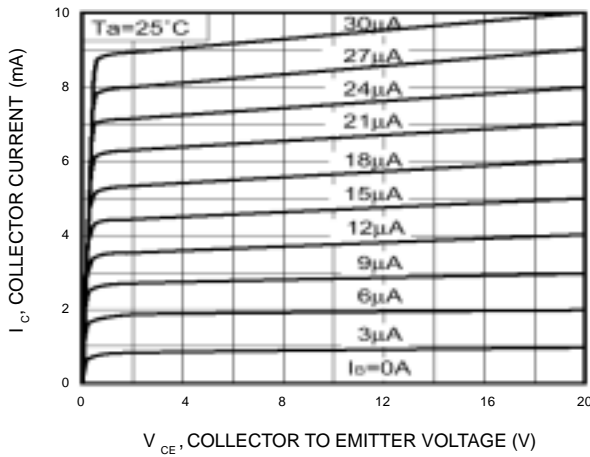

Fig.4 DC current gain vs. collector current (I)

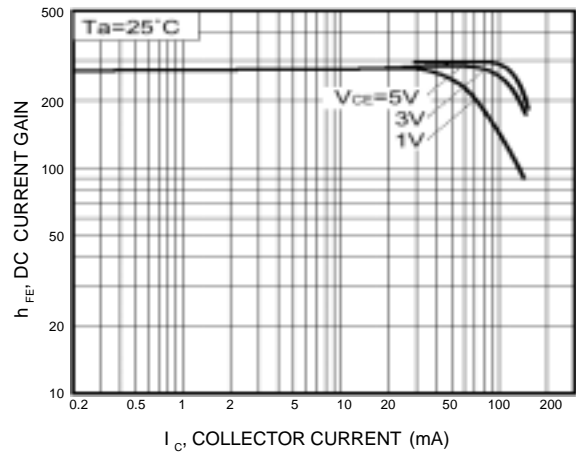

Fig.5 DC current gain vs. collector current (II)

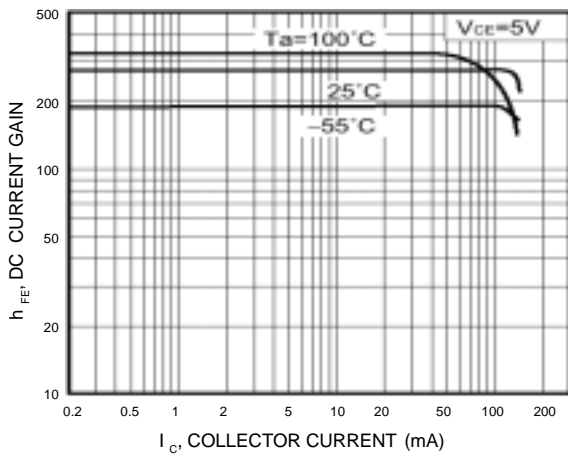

Fig.6 Collector-emitter saturation voltage vs. collector current

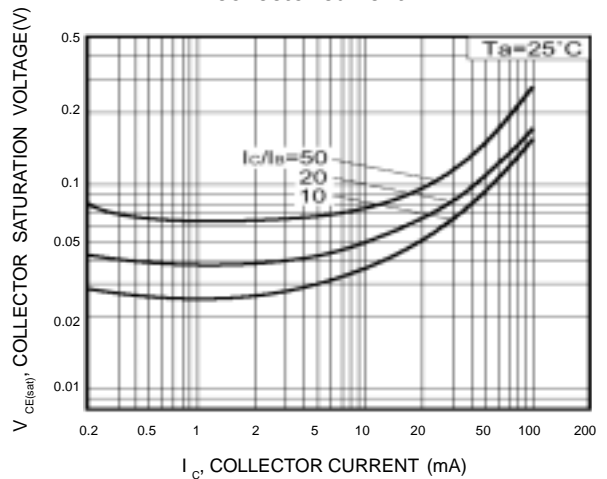

Fig.7 Collector-emitter saturation voltage vs. collector current (I)

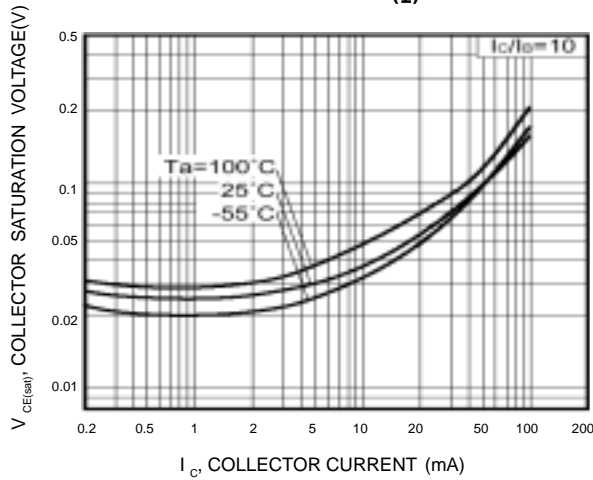

Fig.8 Collector-emitter saturation voltage vs. collector current (II)

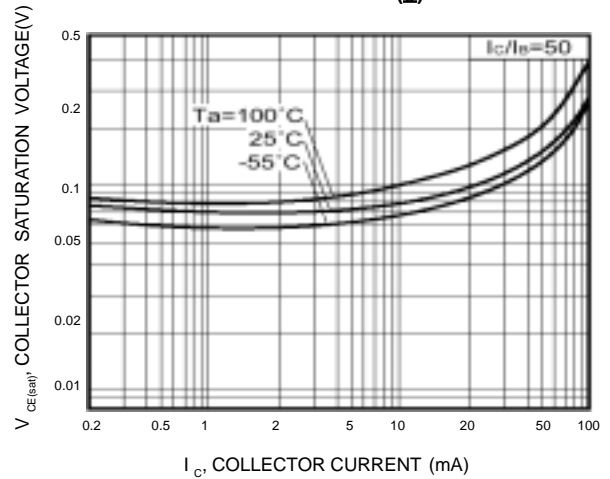

Fig.9 Gain bandwidth product vs. emitter current

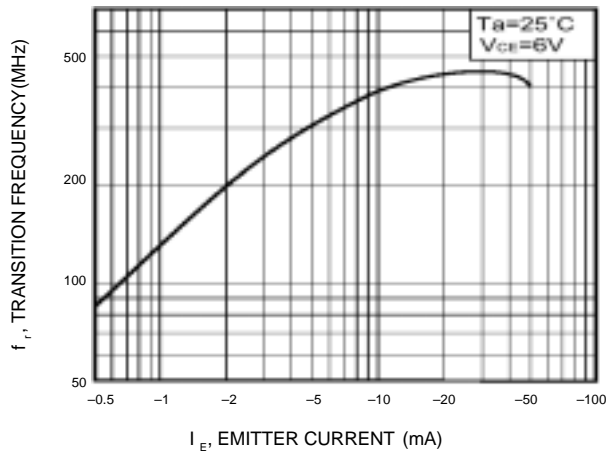

Fig.10 Collector output capacitance vs. collector-base voltage and emitter input capacitance vs. emitter-base voltage

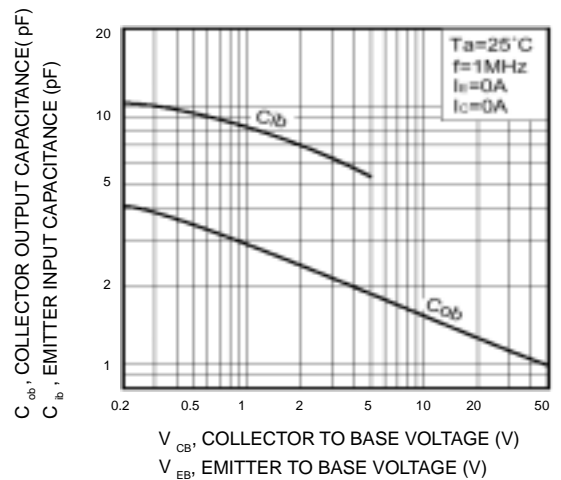
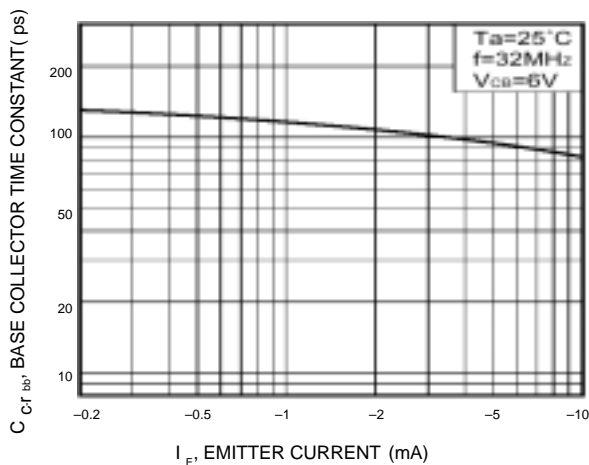
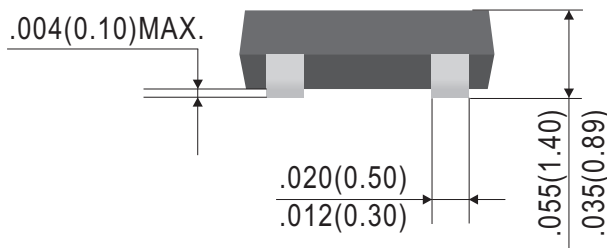
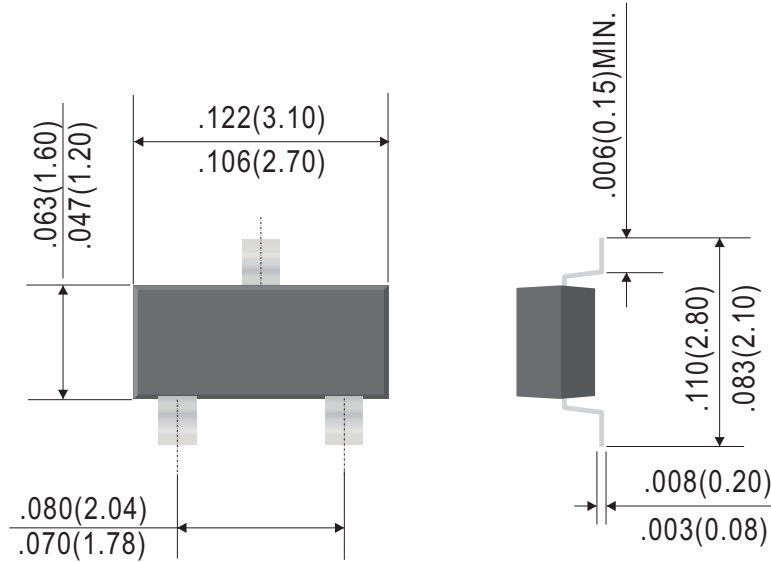

Fig.11 Base-collector time constant vs. emitter current



SOT-23



Dimensions in inches and (millimeters)

