

MITSUBISHI RF POWER TRANSISTOR 2SC2540

NPN EPITAXIAL PLANAR TYPE

DESCRIPTION

2SC2540 is a silicon NPN epitaxial planar type transistor designed for RF power amplifiers in VHF band mobile radio applications.

FEATURES

- High power gain: $G_{pe} \geq 8.2\text{dB}$
@ $V_{CC} = 13.5\text{V}$, $P_O = 40\text{W}$, $f = 175\text{MHz}$
- Emitter ballasted construction and gold metallization for high reliability and good performances.
- Low thermal resistance ceramic package with flange.
- Ability of withstanding more than 20:1 load VSWR when operated at $V_{CC} = 15.2\text{V}$, $P_O = 40\text{W}$, $f = 175\text{MHz}$, $T_C = 25^\circ\text{C}$.

APPLICATION

30 to 35 watts output power amplifiers in VHF band mobile radio applications.

OUTLINE DRAWING

Dimensions in mm

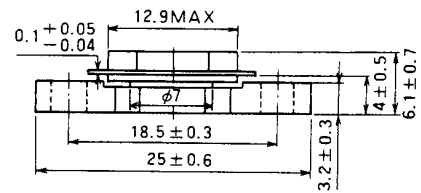
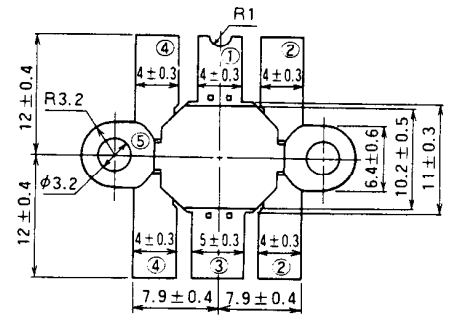

PIN :

- ① COLLECTOR
- ② EMITTER (FLANGE)
- ③ BASE
- ④ EMITTER (FLANGE)
- ⑤ FIN (EMITTER)

T-40E

ABSOLUTE MAXIMUM RATINGS ($T_C = 25^\circ\text{C}$ unless otherwise specified)

Symbol	Parameter	Conditions	Ratings	Unit
V_{CBO}	Collector to base voltage		35	V
V_{EBO}	Emitter to base voltage		4	V
V_{CEO}	Collector to emitter voltage	$R_{BE} = \infty$	17	V
I_C	Collector current		10	A
P_C	Collector dissipation	$T_a = 25^\circ\text{C}$	4.5	W
		$T_C = 25^\circ\text{C}$	80	W
T_j	Junction temperature		175	$^\circ\text{C}$
T_{stg}	Storage temperature		-55 to 175	$^\circ\text{C}$
R_{th-a}	Thermal resistance	Junction to ambient	33.3	$^\circ\text{C}/\text{W}$
R_{th-c}		Junction to case	2	$^\circ\text{C}/\text{W}$

Note. Above parameters are guaranteed independently.

ELECTRICAL CHARACTERISTICS ($T_C = 25^\circ\text{C}$ unless otherwise specified)

Symbol	Parameter	Test conditions	Limits			Unit
			Min	Typ	Max	
$V_{(BR)EBO}$	Emitter to base breakdown voltage	$I_E = 10\text{mA}$, $I_C = 0$	4			V
$V_{(BR)CBO}$	Collector to base breakdown voltage	$I_C = 10\text{mA}$, $I_E = 0$	35			V
$V_{(BR)CEO}$	Collector to emitter breakdown voltage	$I_C = 0.1\text{A}$, $R_{BE} = \infty$	17			V
I_{CBO}	Collector cutoff current	$V_{CB} = 15\text{V}$, $I_E = 0$			2.5	mA
I_{EBO}	Emitter cutoff current	$V_{EB} = 3\text{V}$, $I_C = 0$			2	mA
h_{FE}	DC forward current gain*	$V_{CE} = 10\text{V}$, $I_C = 0.2\text{A}$	10	60	180	—
P_O	Output power	$V_{CC} = 13.5\text{V}$, $P_{in} = 6\text{W}$, $f = 175\text{MHz}$	40	45		W
η_C	Collector efficiency		60	70		%

Note. * Pulse test, $P_W = 150\mu\text{s}$, duty = 5%.

Above parameters, ratings, limits and conditions are subject to change.

NOV. '97

NPN EPITAXIAL PLANAR TYPE

TEST CIRCUIT

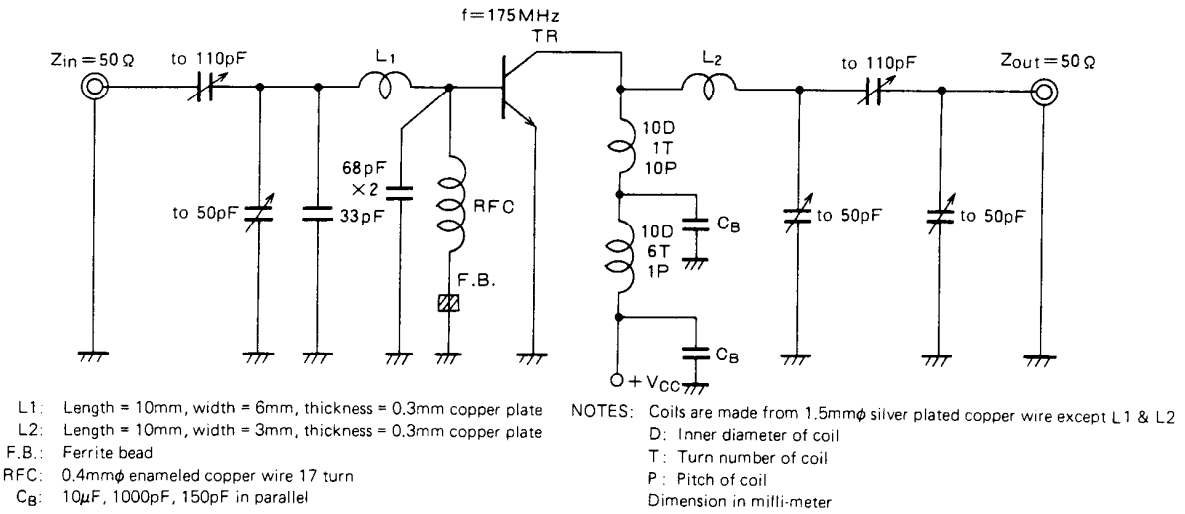

- L1: Length = 10mm, width = 6mm, thickness = 0.3mm copper plate
- L2: Length = 10mm, width = 3mm, thickness = 0.3mm copper plate
- F.B.: Ferrite bead
- RFC: 0.4mmϕ enameled copper wire 17 turn
- CB: 10μF, 1000pF, 150pF in parallel

TYPICAL PERFORMANCE DATA

COLLECTOR DISSIPATION VS. AMBIENT TEMPERATURE

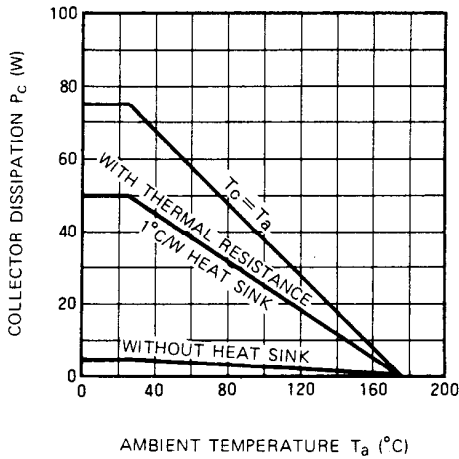

COLLECTOR CURRENT VS. COLLECTOR TO EMITTER VOLTAGE

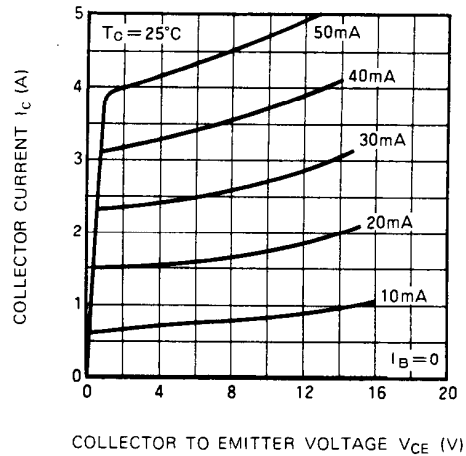

COLLECTOR TO EMITTER BREAKDOWN VOLTAGE VS. BASE TO EMITTER RESISTANCE

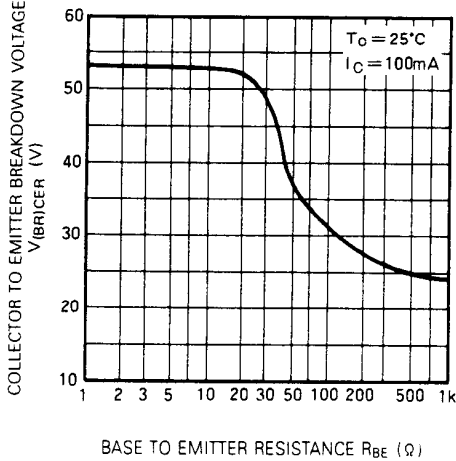

DC CURRENT GAIN VS. COLLECTOR CURRENT

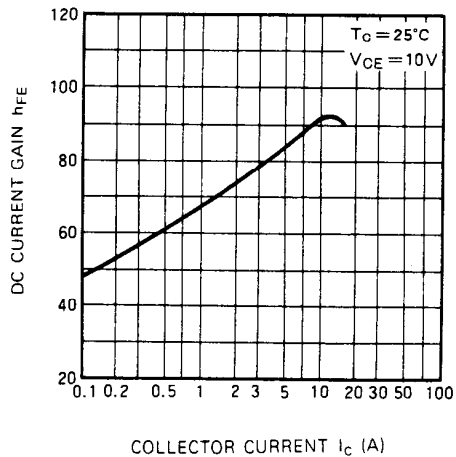

NPN EPITAXIAL PLANAR TYPE

COLLECTOR OUTPUT CAPACITANCE VS. COLLECTOR TO BASE VOLTAGE

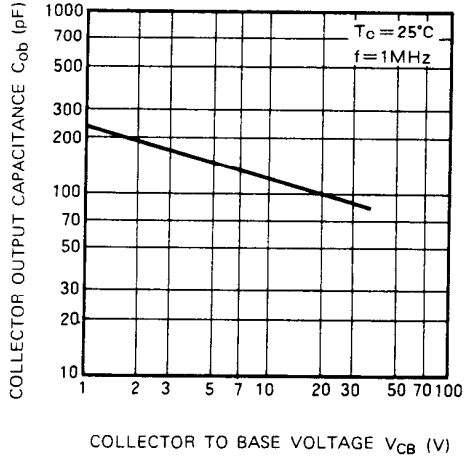

OUTPUT POWER, COLLECTOR EFFICIENCY VS. INPUT POWER

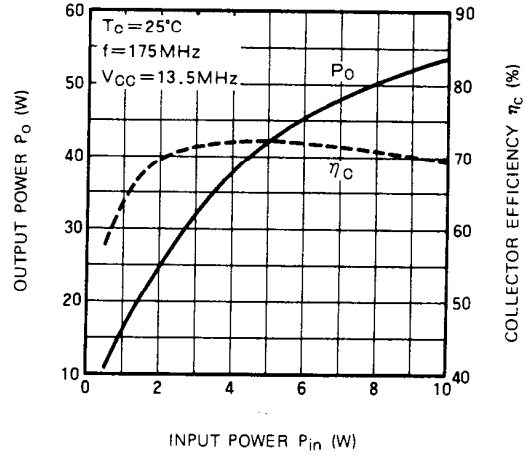

OUTPUT POWER VS. COLLECTOR SUPPLY VOLTAGE

