

描述 / Descriptions

TO-92 塑封封装 NPN 半导体三极管。Silicon NPN transistor in a TO-92 Plastic Package.

特征 / Features

P_C, I_C 大。
High P_C and I_C .

用途 / Applications

用于 2W 乙类推挽功放。
2W output amplifier of portable radios in class B push-pull operation.

内部等效电路 / Equivalent Circuit

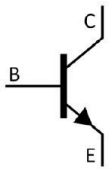

引脚排列 / Pinning



PIN1 : Collector PIN 2 : Base PIN 3 : Emitter

放大及印章代码 / hFE Classifications & Marking

见印章说明。See Marking Instructions.

极限参数 / Absolute Maximum Ratings(Ta=25°C)

| 参数 Parameter | 符号 Symbol | 数值 Rating | 单位 Unit |
|--------------------------------|--------------|--------------|------------|
| Collector to Base Voltage | V_{CBO} | 40 | V |
| Collector to Emitter Voltage | V_{CEO} | 25 | V |
| Emitter to Base Voltage | V_{EBO} | 6.0 | V |
| Collector Current - Continuous | I_C | 1.5 | A |
| Base Current - Continuous | I_B | 500 | mA |
| Collector Power Dissipation | P_C | 1.0 | W |
| Junction Temperature | T_j | 150 | °C |
| Storage Temperature Range | T_{stg} | -55~150 | °C |

电性能参数 / Electrical Characteristics(Ta=25°C)

| 参数 Parameter | 符号 Symbol | 测试条件 Test Conditions | 最小值 Min | 典型值 Typ | 最大值 Max | 单位 Unit |
|---|---------------|---------------------------------|------------|------------|------------|------------|
| Collector to Base Breakdown Voltage | V_{CBO} | $I_C=0.1mA$ $I_E=0$ | 40 | | | V |
| Collector to Emitter Breakdown Voltage | V_{CEO} | $I_C=2.0mA$ $I_B=0$ | 25 | | | V |
| Emitter to Base Breakdown Voltage | V_{EBO} | $I_E=0.1mA$ $I_C=0$ | 6.0 | | | V |
| Collector Cut-Off Current | I_{CBO} | $V_{CB}=35V$ $I_E=0$ | | | 0.1 | μA |
| Emitter Cut-Off Current | I_{EBO} | $V_{EB}=6.0V$ $I_C=0$ | | | 0.1 | μA |
| DC Current Gain | $h_{FE(1)}$ | $V_{CE}=1.0V$ $I_C=100mA$ | 200 | | 350 | |
| | $h_{FE(2)}$ | $V_{CE}=1.0V$ $I_C=800mA$ | 40 | | | |
| | $h_{FE(3)}$ | $V_{CE}=1.0V$ $I_C=5.0mA$ | 45 | | | |
| Collector-to-Emitter Saturation Voltage | $V_{CE(sat)}$ | $I_C=800mA$ $I_B=80mA$ | | 0.28 | 0.5 | V |
| Base-to-Emitter Saturation Voltage | $V_{BE(sat)}$ | $I_C=800mA$ $I_B=80mA$ | | 0.98 | 1.2 | V |
| Base-to-Emitter Voltage | V_{BE} | $V_{CE}=1.0V$ $I_C=10mA$ | | 0.66 | 1.0 | V |
| Transition Frequency | f_T | $V_{CE}=10V$ $I_C=50mA$ | 100 | 190 | | MHz |
| Output Capacitance | C_{ob} | $V_{CB}=10V$ $f=1.0MHz$ $I_E=0$ | | 9.0 | | pF |

电参数曲线图 / Electrical Characteristic Curve

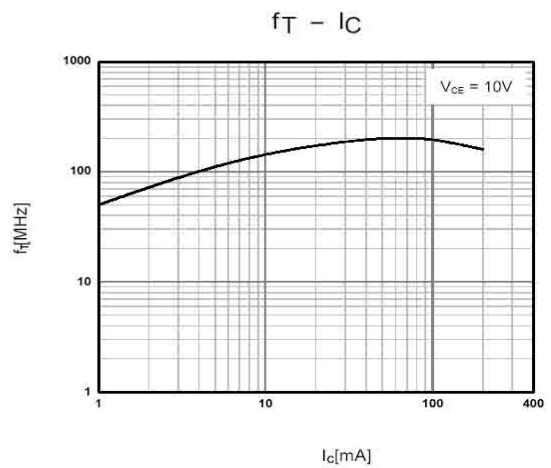
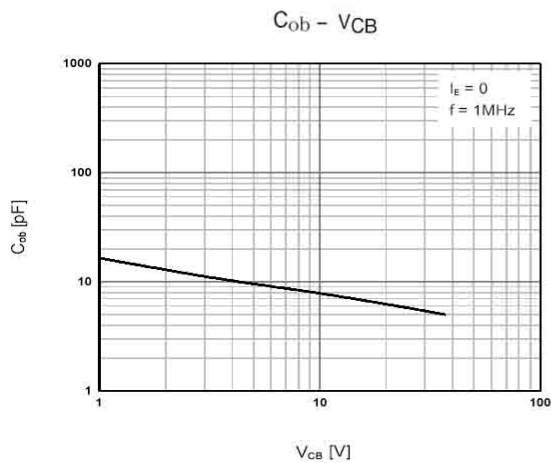
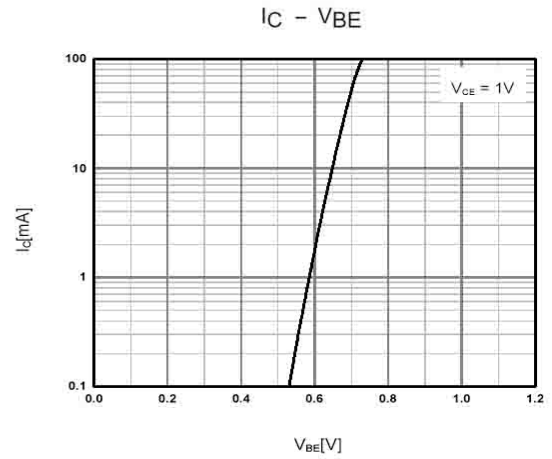
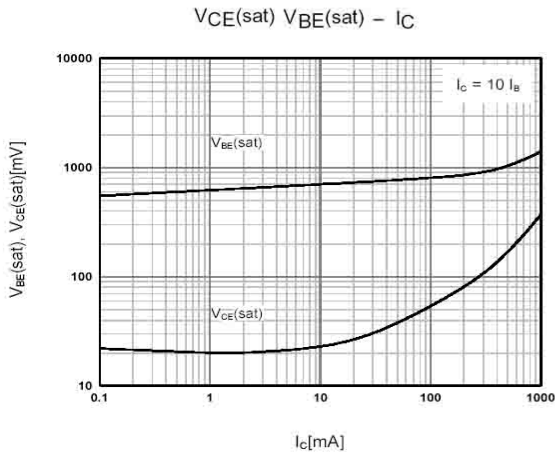
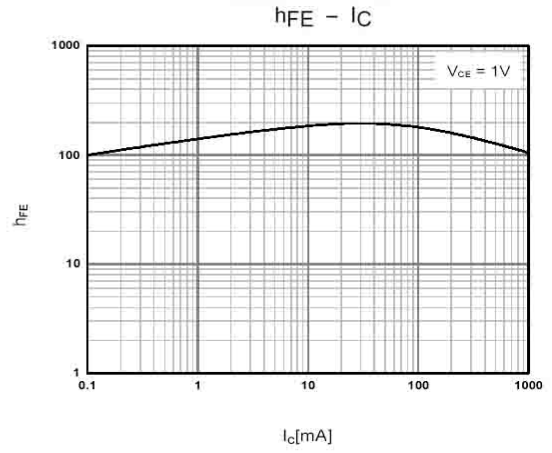
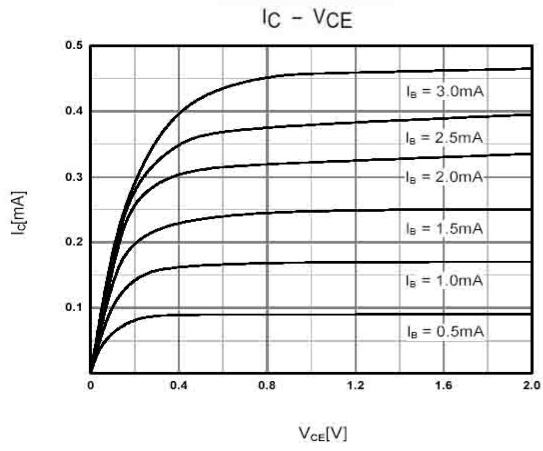

外形尺寸图 / Package Dimensions

TO-92

Unit: mm

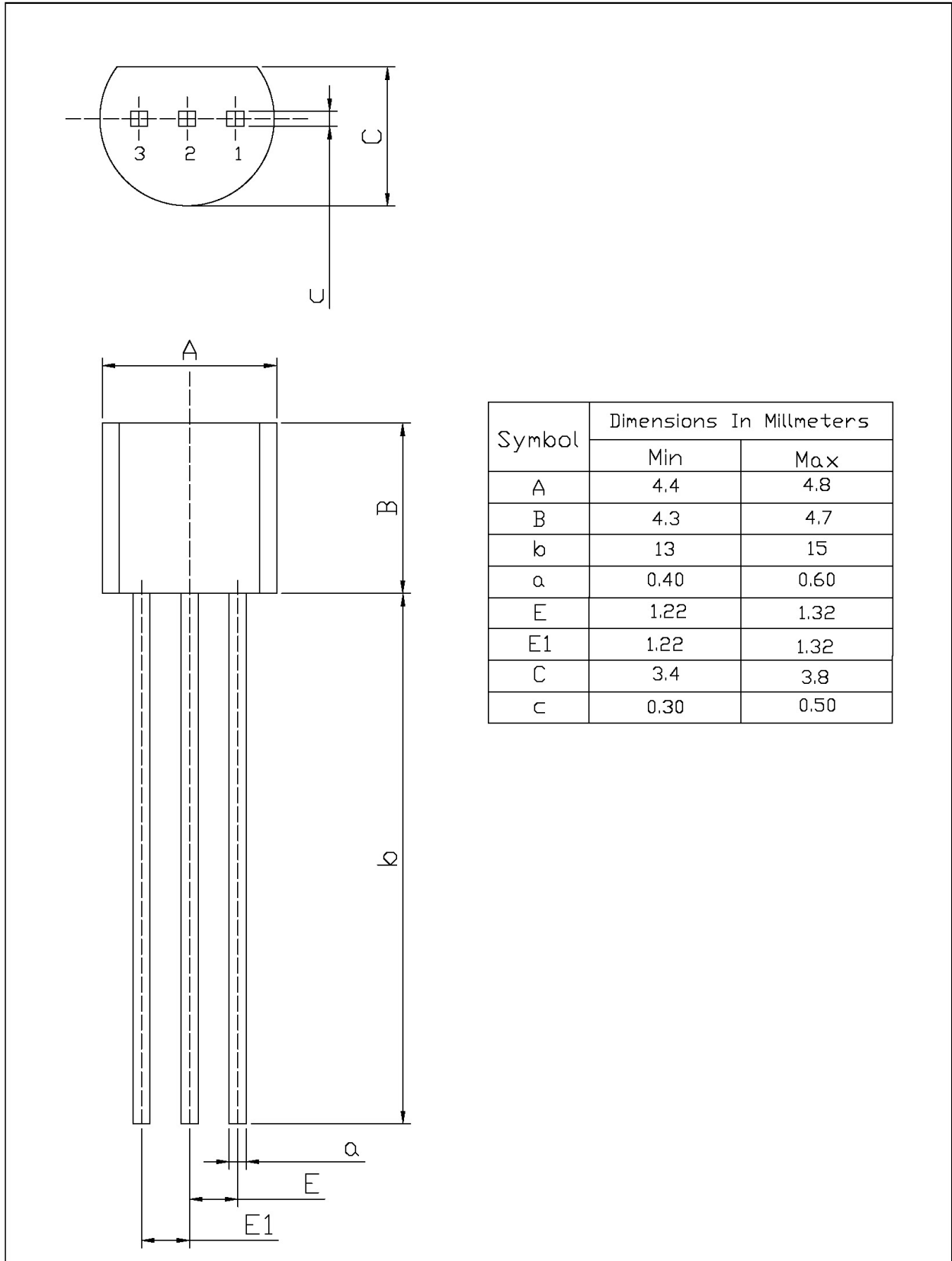

印章说明 / Marking Instructions

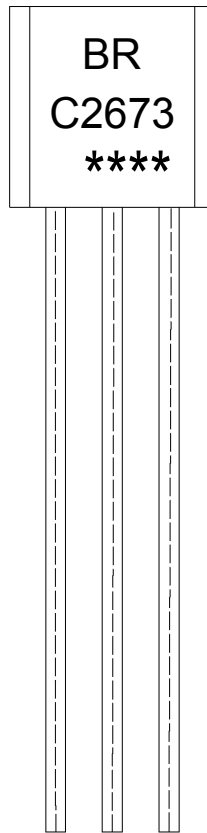

说明：

BR: 为公司代码

C2673 : 为型号代码

**** : 为生产批号代码，随生产批号变化。

Note:

BR: Company Code.

C2673: Product Type.

****: Lot No. Code,code change with Lot No.

波峰焊温度曲线图(无铅) / Temperature Profile for Dip Soldering(Pb-Free)



说明：

- 1、预热温度 25 ~ 150°C，时间 60 ~ 90sec;
- 2、峰值温度 255±5°C，时间持续为 5±0.5sec;
- 3、焊接制程冷却速度为 2 ~ 10°C/sec.

Note:

- 1.Preheating:25~150°C, Time:60~90sec.
- 2.Peak Temp.:255±5°C, Duration:5±0.5sec.
3. Cooling Speed: 2~10°C/sec.

耐焊接热试验条件 / Resistance to Soldering Heat Test Conditions

温度：270±5°C

时间：10±1 sec.

Temp:270±5°C

Time:10±1 sec

包装规格 / Packaging SPEC.

散件包装 / BULK

| Package Type 封装形式 | Units 包装数量 | | | | | Dimension 包装尺寸 (unit: mm3) | | |
|----------------------|------------------|-----------------------|------------------------|------------------------------|------------------------|----------------------------|-------------|-------------|
| | Units/Bag 只/袋 | Bags/Inner Box 袋/盒 | Units/Inner Box 只/盒 | Inner Boxes/Outer Box 盒/箱 | Units/Outer Box 只/箱 | Bag 袋 | Inner Box 盒 | Outer Box 箱 |
| TO-92 | 1,000 | 10 | 10,000 | 5 | 50,000 | 135×190 | 237×172×102 | 560×245×195 |
| | 1,000 | 10 | 10,000 | 10 | 100,000 | 135×190 | 237×172×102 | 560×245×375 |

编带包装 / AMMO

| Package Type 封装形式 | Units 包装数量 | | | | | Dimension 包装尺寸 (unit: mm3) | |
|----------------------|--------------------|------------------------|-------------------------|------------------------------|------------------------|----------------------------|-----------------------------------|
| | Units/tape 只/纸带 | Tape/Inner Box 纸带/盒 | Rows/Inner Box 纸带层/盒 | Inner Boxes/Outer Box 盒/箱 | Units/Outer Box 只/箱 | Inner Box 盒 | Outer Box 箱 |
| TO-92 | 3,000 | 1 | 120 | 10 | 30,000 | 328×230×42 | 小箱 480×346×235, 大箱 547×407×268 |

使用说明 / Notices