



2SC2712

NPN SILICON TRANSISTOR

AUDIO FREQUENCY AMPLIFIER NPN TRANSISTOR

■ FEATURES

- * High Voltage and High Current:
V_{CEO}=50V, I_C=150mA (Max.)
- * Excellent h_{FE} Linearity:
h_{FE}(I_C=0.1mA)/h_{FE}(I_C=2mA)=0.95(Typ.)
- * High h_{FE}
- * Low Noise

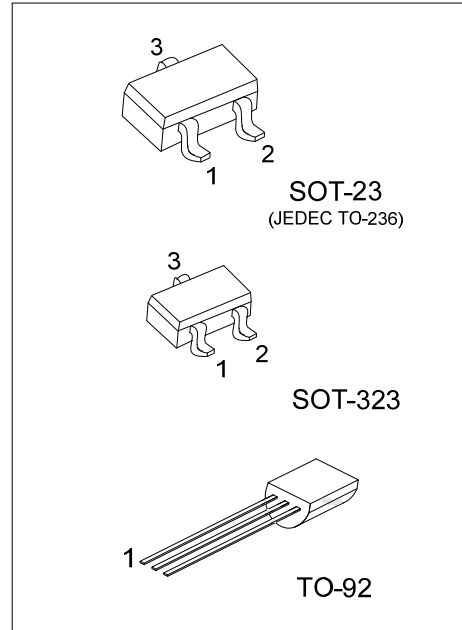

■ ORDERING INFORMATION

Ordering Number		Package	Pin Assignment			Packing
Lead Free	Halogen Free		1	2	3	
2SC2712L-x-AE3-R	2SC2712G-x-AE3-R	SOT-23	B	E	C	Tape Reel
2SC2712L-x-AL3-R	2SC2712G-x-AL3-R	SOT-323	B	E	C	Tape Reel
2SC2712L-x-T92-R	2SC2712G-x-T92-R	TO-92	E	C	B	Tape Reel

Note: Pin assignment: B: Base E: Emitter C: Collector

<p>2SC2712G-x-AE3-R</p> <p>(1)Packing Type (2)Package Type (3)Rank (4)Green Package</p>	<p>(1) R: Tape Reel (2) AE3: SOT-23, AL3: SOT-323, T92: TO-92 (3) x: refer to Classification of h_{FE} (4) G: Halogen Free and Lead Free, L: Lead Free</p>
---	--

■ MARKING

For SOT-23/SOT-323

2SC2712-Y	2SC2712-G	2SC2712-L
<p>L: Lead Free G: Halogen Free</p>	<p>L: Lead Free G: Halogen Free</p>	<p>L: Lead Free G: Halogen Free</p>

For TO-92

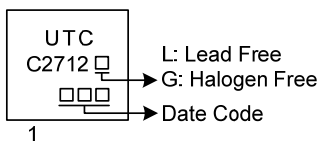

■ ABSOLUTE MAXIMUM RATINGS ($T_A=25^\circ\text{C}$, unless otherwise stated)

PARAMETER		SYMBOL	RATINGS	UNIT
Collector-Base Voltage		V_{CBO}	60	V
Collector-Emitter Voltage		V_{CEO}	50	V
Emitter-Base Voltage		V_{EBO}	5	V
Collector Current		I_C	150	mA
Base Current		I_B	30	mA
Collector Power Dissipation	SOT-23/SOT-323	P_C	150	mW
	TO-92		625	mW
Junction Temperature		T_J	+125	$^\circ\text{C}$
Storage Temperature		T_{STG}	-55 ~ +125	$^\circ\text{C}$

Note Absolute maximum ratings are those values beyond which the device could be permanently damaged. Absolute maximum ratings are stress ratings only and functional device operation is not implied.

■ ELECTRICAL CHARACTERISTICS ($T_A=25^\circ\text{C}$, unless otherwise stated)

PARAMETER	SYMBOL	TEST CONDITIONS	MIN	TYP	MAX	UNIT
Collector Cut-off Current	I_{CBO}	$V_{CB}=60\text{V}, I_E=0$			0.1	μA
Emitter Cut-off Current	I_{EBO}	$V_{EB}=5\text{V}, I_C=0$			0.1	μA
DC Current Gain	h_{FE}	$V_{CE}=6\text{V}, I_C=2\text{mA}$	70		700	
Collector-Emitter Saturation Voltage	$V_{CE(SAT)}$	$I_C=100\text{mA}, I_B=10\text{mA}$		0.1	0.25	V
Transistor Frequency	f_T	$V_{CE}=10\text{V}, I_C=1\text{mA}$	80			MHz
Collector Output Capacitance	C_{ob}	$V_{CB}=10\text{V}, I_E=0, f=1\text{MHz}$		2.0	3.5	pF
Noise Figure	NF	$V_{CE}=6\text{V}, I_C=0.1\text{mA}$ $f=1\text{kHz}, R_g=10\text{K}\Omega$		1.0	10	dB

■ CLASSIFICATION OF h_{FE}

RANK	Y	G	L
RANGE	120~240	200~400	350~700

TYPICAL CHARACTERISTICS

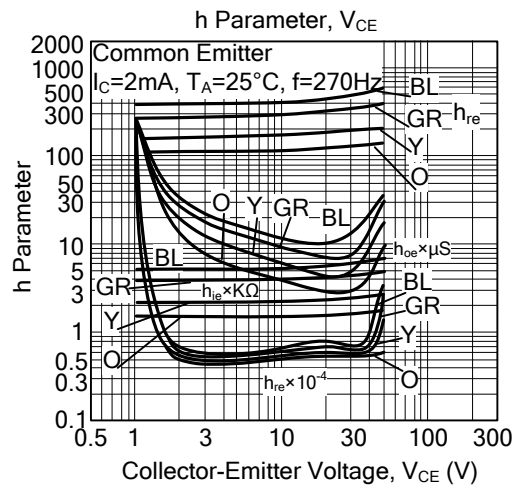
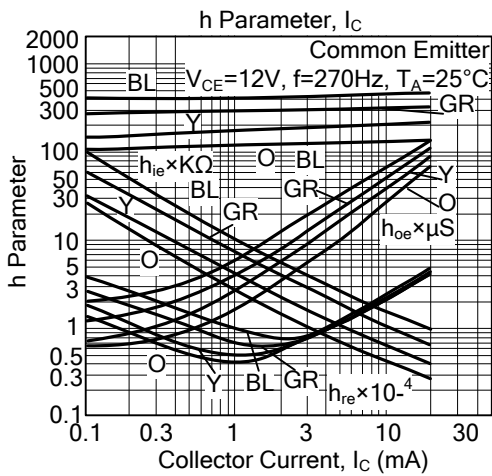
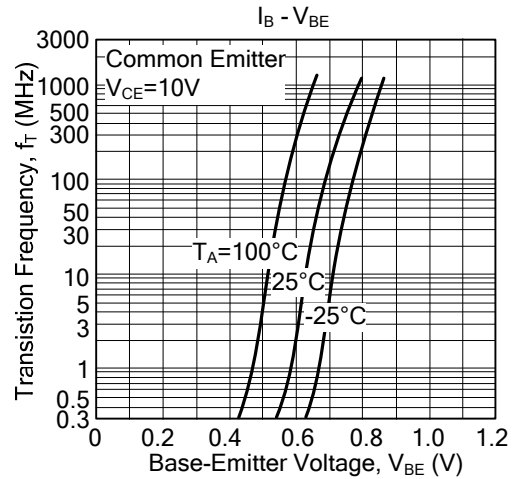
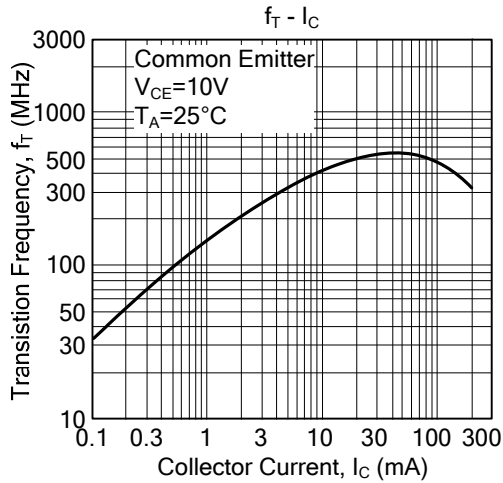
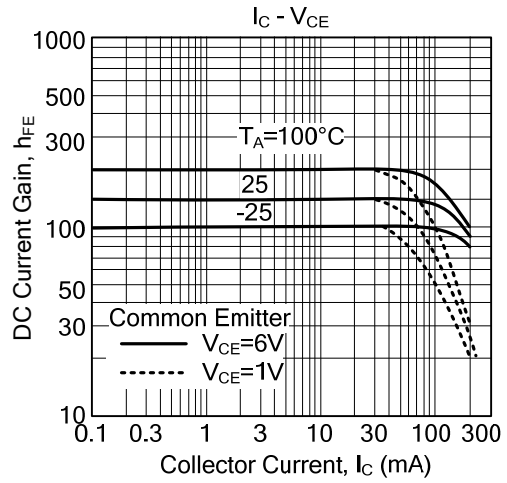
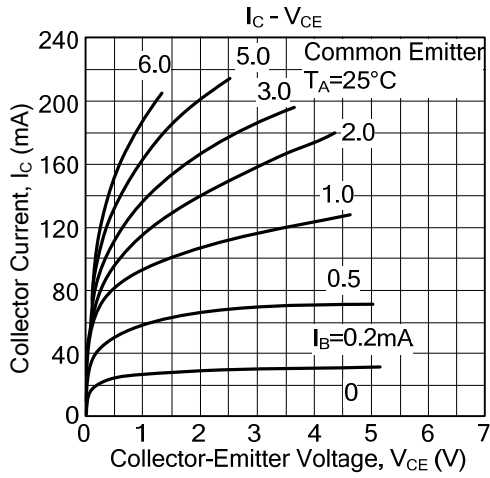

■ TYPICAL CHARACTERISTICS (Cont.)

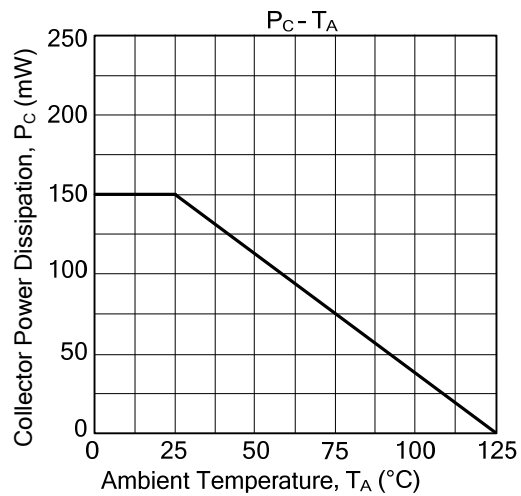

UTC assumes no responsibility for equipment failures that result from using products at values that exceed, even momentarily, rated values (such as maximum ratings, operating condition ranges, or other parameters) listed in products specifications of any and all UTC products described or contained herein. UTC products are not designed for use in life support appliances, devices or systems where malfunction of these products can be reasonably expected to result in personal injury. Reproduction in whole or in part is prohibited without the prior written consent of the copyright owner. UTC reserves the right to make changes to information published in this document, including without limitation specifications and product descriptions, at any time and without notice. This document supersedes and replaces all information supplied prior to the publication hereof.