

TOSHIBA Transistor Silicon NPN Epitaxial Type (PCT process)

2SC2995

FM/AM RF, MIX, OSC, IF
High Frequency Amplifier Applications

- High stability oscillation voltage on FM local oscillator.
- Recommend FM/AM RF, MIX, OSC and IF.

Maximum Ratings (Ta = 25°C)

Characteristics	Symbol	Rating	Unit
Collector-base voltage	V_{CBO}	40	V
Collector-emitter voltage	V_{CEO}	30	V
Emitter-base voltage	V_{EBO}	4	V
Collector current	I_C	50	mA
Base current	I_B	10	mA
Collector power dissipation	P_C	200	mW
Junction temperature	T_j	125	°C
Storage temperature range	T_{stg}	-55~125	°C

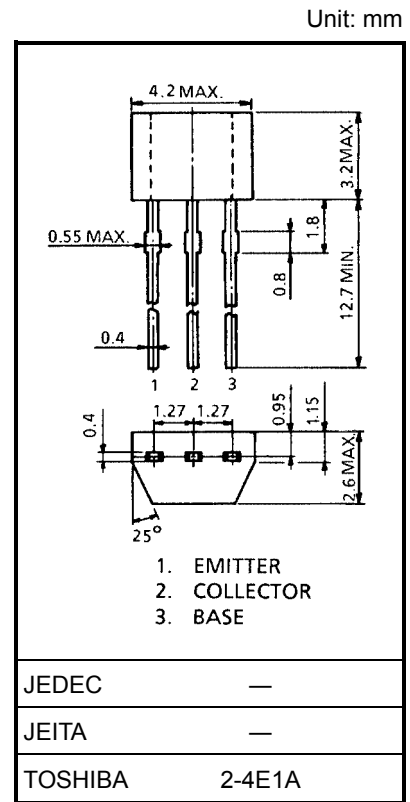

Weight: 0.13 g (typ.)

Electrical Characteristics (Ta = 25°C)

Characteristics	Symbol	Test Condition	Min	Typ.	Max	Unit
Collector cut-off current	I_{CBO}	$V_{CB} = 40\text{ V}, I_E = 0$	—	—	0.1	μA
Emitter cut-off current	I_{EBO}	$V_{EB} = 4\text{ V}, I_C = 0$	—	—	0.5	μA
DC current gain	h_{FE} (Note)	$V_{CE} = 6\text{ V}, I_C = 1\text{ mA}$	40	—	240	
Reverse transfer capacitance	C_{re}	$V_{CE} = 6\text{ V}, f = 1\text{ MHz}$	—	0.9	1.3	pF
Transition frequency	f_T	$V_{CE} = 6\text{ V}, I_E = -1\text{ mA}$	150	350	—	MHz
Collector-base time constant	$C_c \cdot I_{bb'}$	$V_{CB} = 6\text{ V}, I_E = -1\text{ mA}, f = 30\text{ MHz}$	—	15	30	ps
Noise figure	NF	$V_{CC} = 6\text{ V}, I_E = -1\text{ mA}, f = 100\text{ MHz}$	—	4.0	—	dB
Power gain	G_{pe}	(Figure 1)	—	15	—	dB
Oscillation output voltage	V_{OSC}	$V_{CC} = 6\text{ V}, f = 100\text{ MHz}$ (Figure 2)	—	150	—	mV

Note: h_{FE} classification R: 40~80, O: 70~140, Y: 120~240

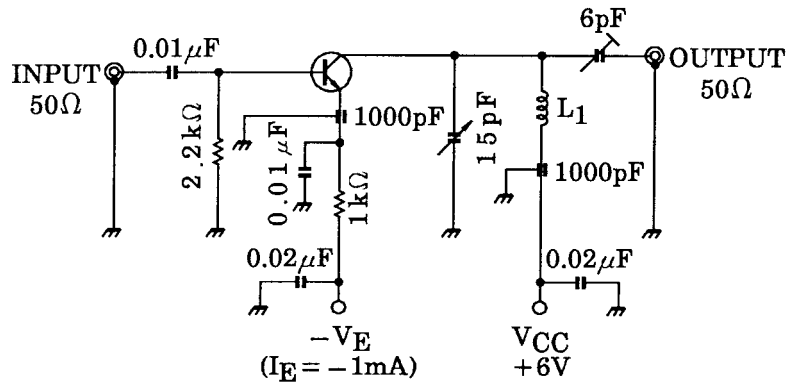

L₁: 0.8 mmφ silver plated copper wire, 4 T, 10ID, 8 length

Figure 1 NF, G_{pe} Test Circuit

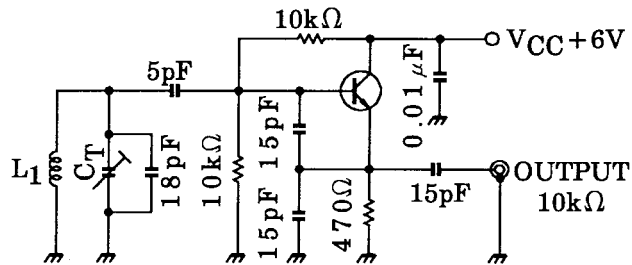

L₁: 0.8 mmφ silver plated copper wire, 4 T, 10ID, 8 length

Figure 2 V_{osc} Test Circuit

STATIC CHARACTERISTICS

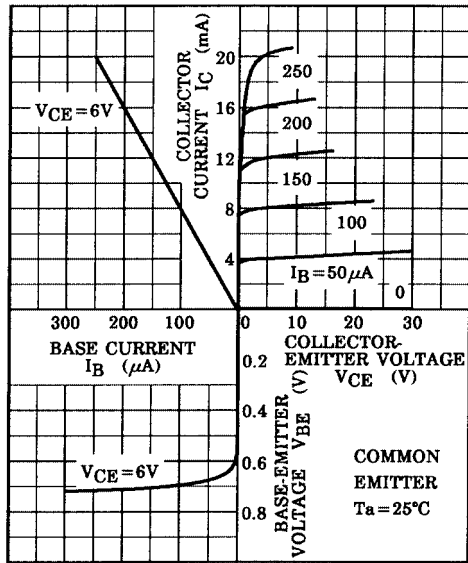

$h_{FE} - I_C$

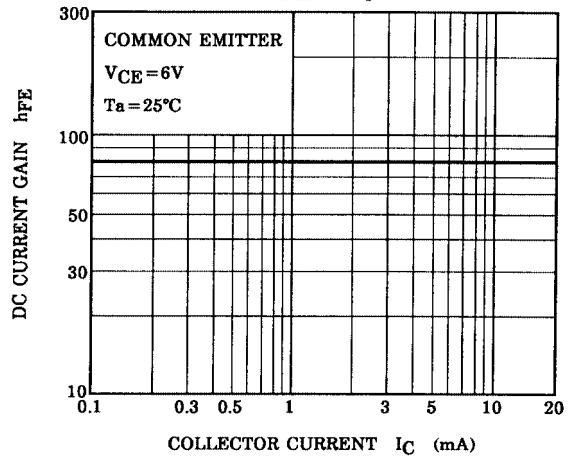

$C_{ie}, g_{ie} - I_E$

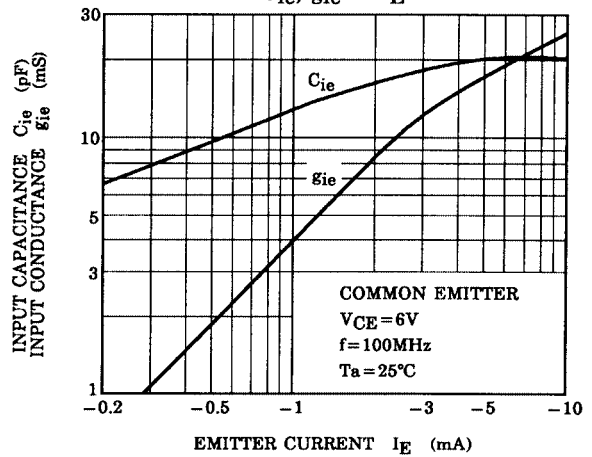

$C_{oe}, g_{oe} - I_E$

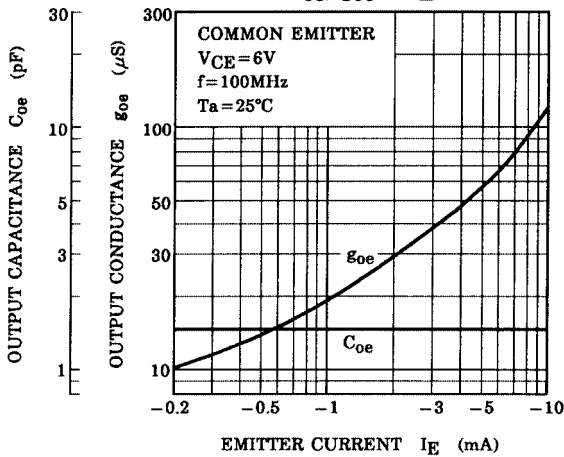

$|Y_{re}|, \theta_{re} - I_E$

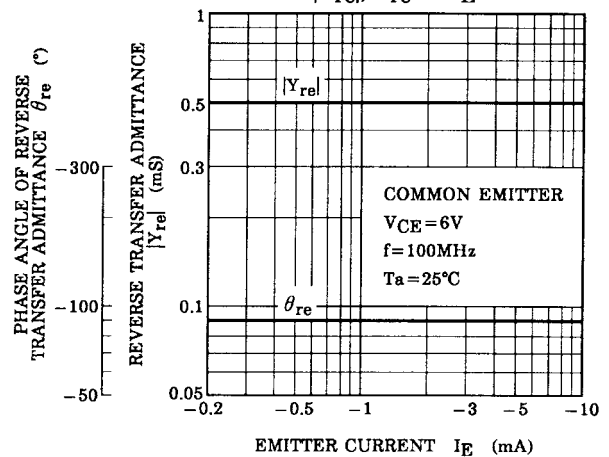

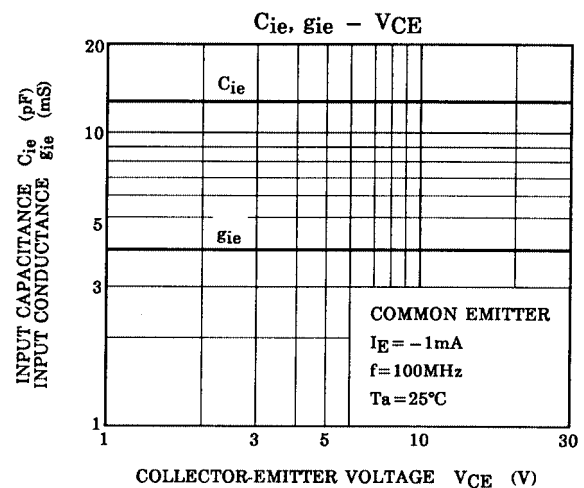
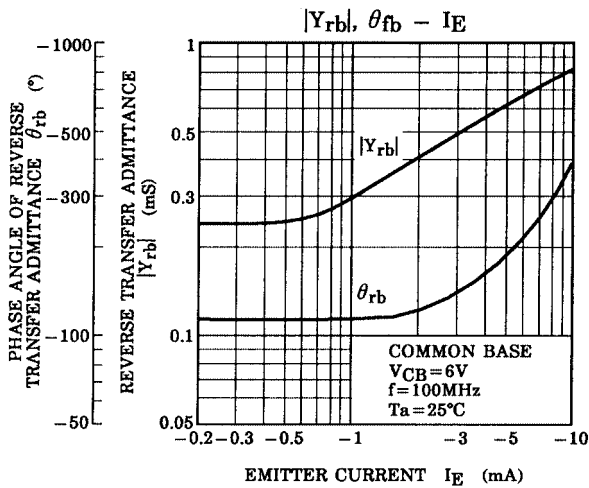
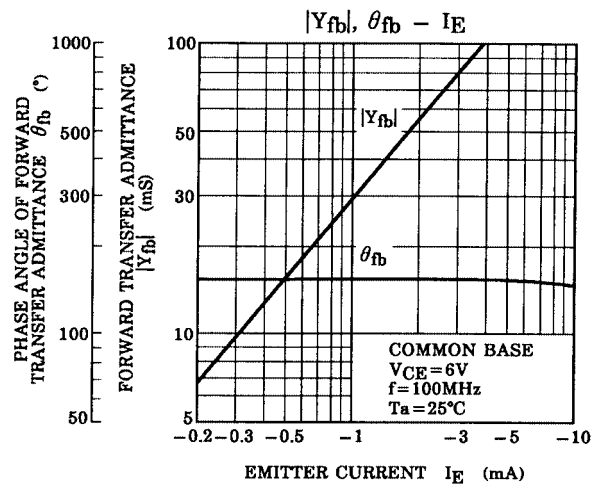
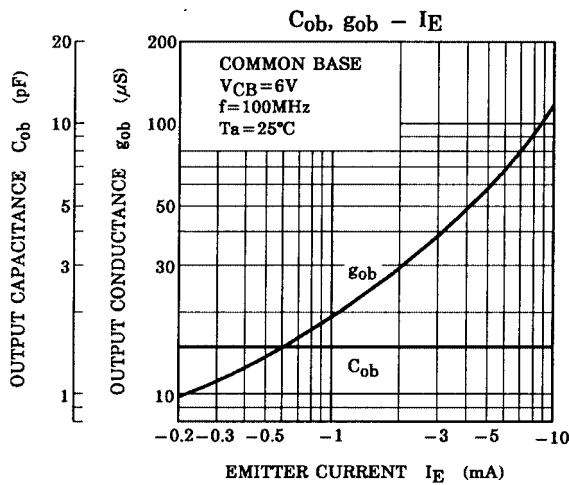
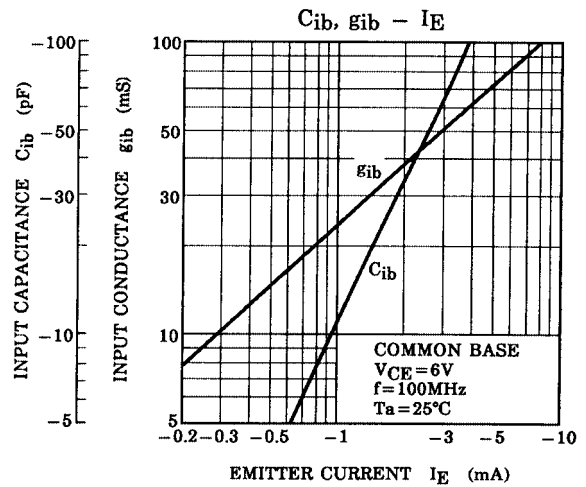
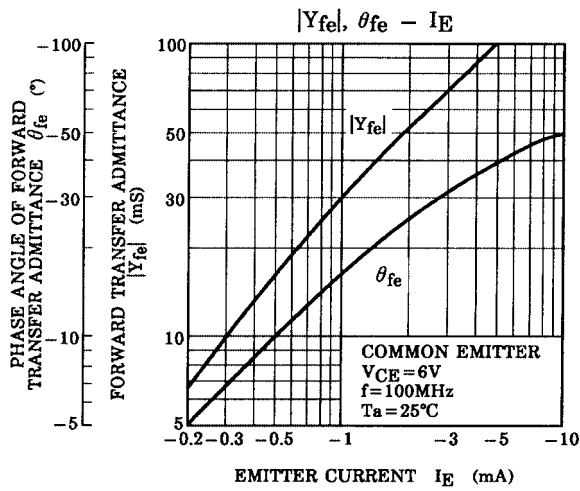

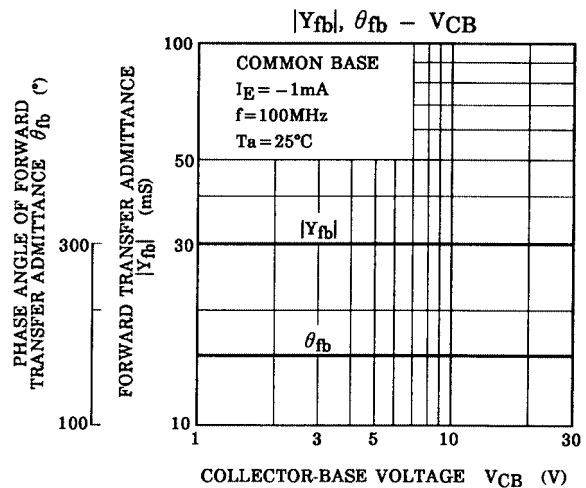
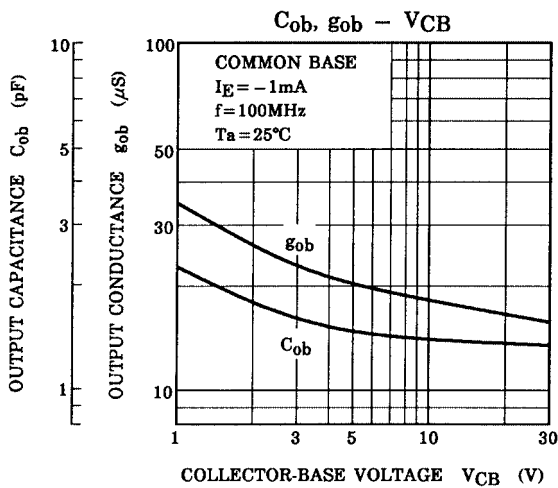
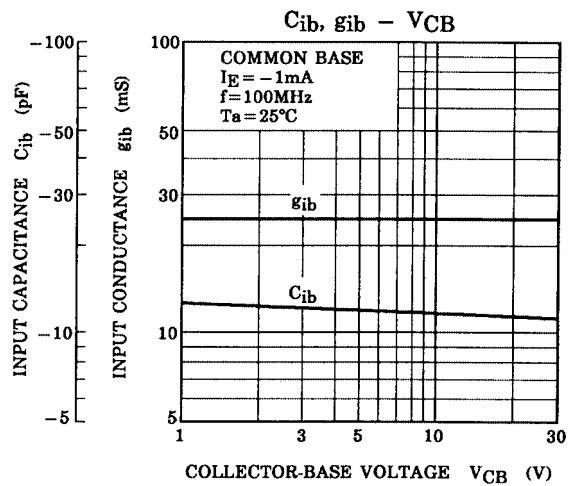
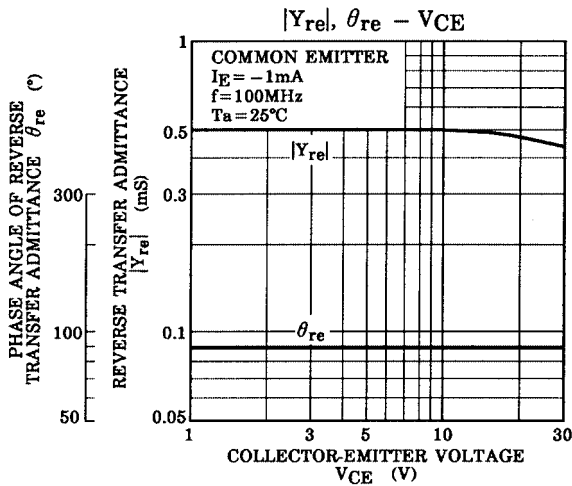
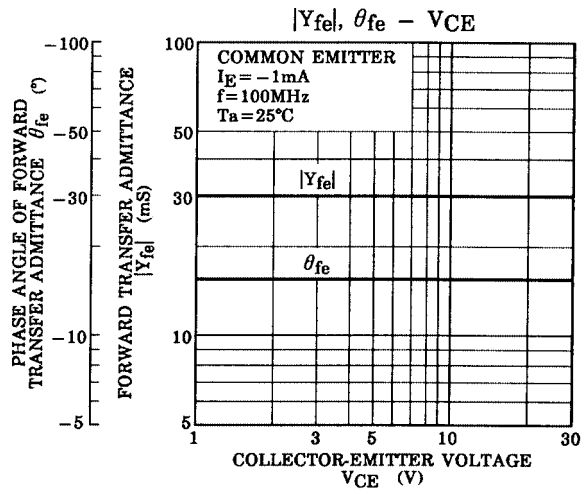
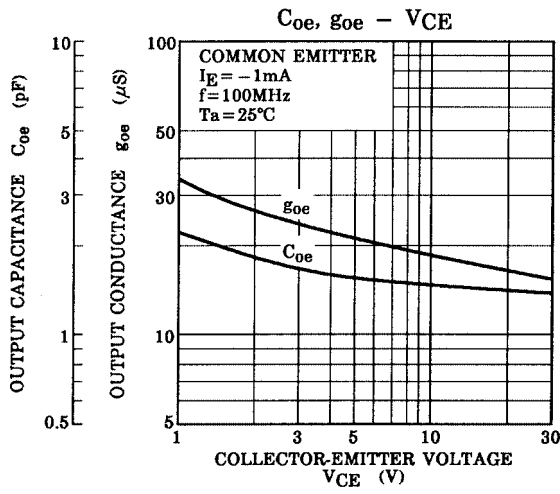

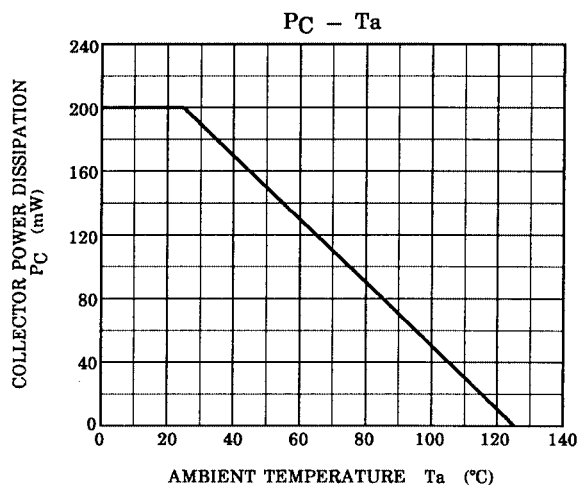
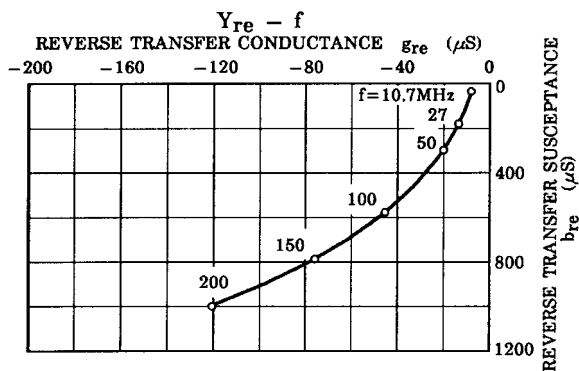
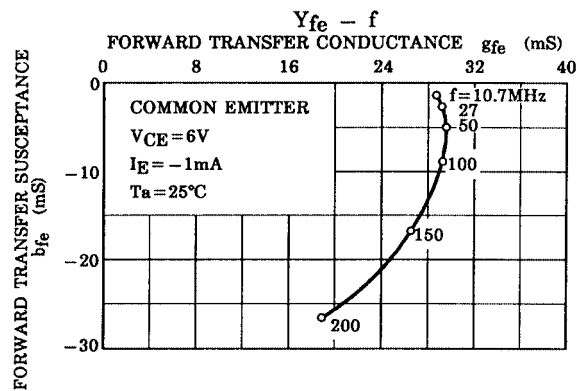
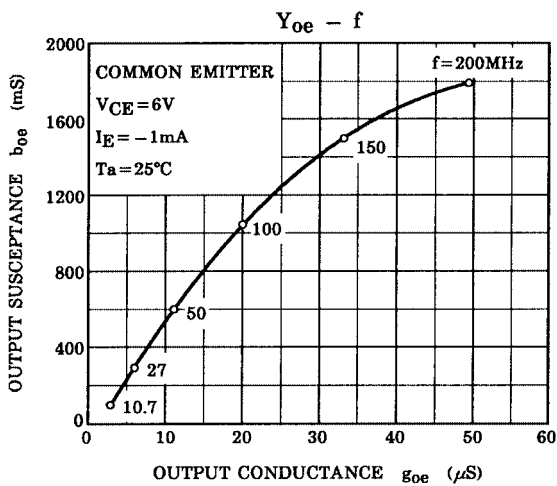
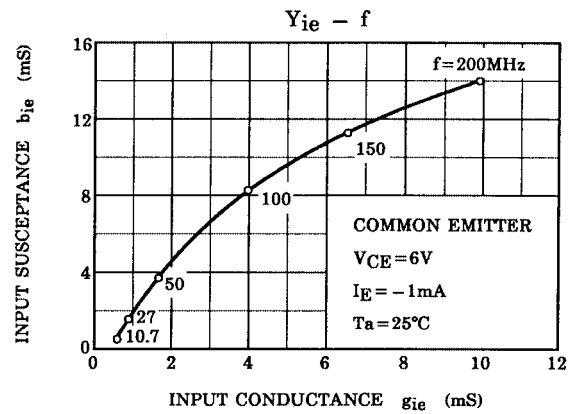
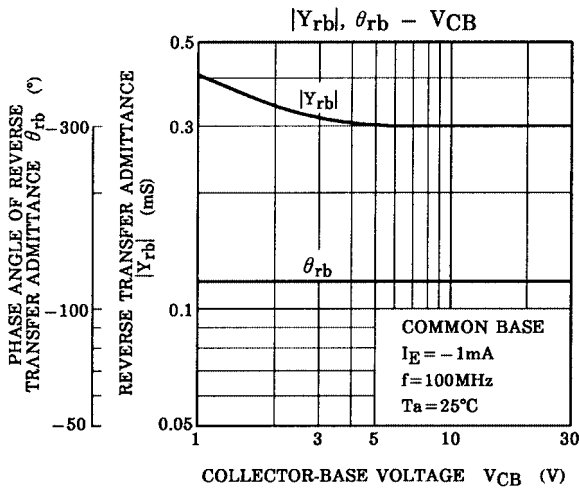

RESTRICTIONS ON PRODUCT USE

000707EAA

- TOSHIBA is continually working to improve the quality and reliability of its products. Nevertheless, semiconductor devices in general can malfunction or fail due to their inherent electrical sensitivity and vulnerability to physical stress. It is the responsibility of the buyer, when utilizing TOSHIBA products, to comply with the standards of safety in making a safe design for the entire system, and to avoid situations in which a malfunction or failure of such TOSHIBA products could cause loss of human life, bodily injury or damage to property.
In developing your designs, please ensure that TOSHIBA products are used within specified operating ranges as set forth in the most recent TOSHIBA products specifications. Also, please keep in mind the precautions and conditions set forth in the "Handling Guide for Semiconductor Devices," or "TOSHIBA Semiconductor Reliability Handbook" etc..
- The TOSHIBA products listed in this document are intended for usage in general electronics applications (computer, personal equipment, office equipment, measuring equipment, industrial robotics, domestic appliances, etc.). These TOSHIBA products are neither intended nor warranted for usage in equipment that requires extraordinarily high quality and/or reliability or a malfunction or failure of which may cause loss of human life or bodily injury ("Unintended Usage"). Unintended Usage include atomic energy control instruments, airplane or spaceship instruments, transportation instruments, traffic signal instruments, combustion control instruments, medical instruments, all types of safety devices, etc.. Unintended Usage of TOSHIBA products listed in this document shall be made at the customer's own risk.
- The information contained herein is presented only as a guide for the applications of our products. No responsibility is assumed by TOSHIBA CORPORATION for any infringements of intellectual property or other rights of the third parties which may result from its use. No license is granted by implication or otherwise under any intellectual property or other rights of TOSHIBA CORPORATION or others.
- The information contained herein is subject to change without notice.