

2SC3174

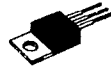

T-33-11

2010A

NPN Epitaxial Planar Silicon Transistor

CRT Display Horizontal Deflection Output Applications (with Damper Diode)

©1310B

Features:

- High switching speed
- Especially suited for use in high-definition CRT display ($V_{CC}=6$ to $12V$)
- Wide ASO and durable against breakdown

Absolute Maximum Ratings at $T_a=25^\circ C$

			unit
Collector to Base Voltage	V_{CB0}	330	V
Collector to Emitter Voltage	V_{CE0}	150	V
Emitter to Base Voltage	V_{EB0}	6	V
Collector Current	I_C	7	A
Peak Collector Current	i_{cp}	12	A
Base Current	I_B	4	A
Collector Dissipation	P_C $T_c=25^\circ C$	50	W
Junction Temperature	T_j	150	$^\circ C$
Storage Temperature	T_{stg}	-55 to +150	$^\circ C$

Electrical Characteristics at $T_a=25^\circ C$

			min	typ	max	unit
Collector Cutoff Current	I_{CBO} $V_{CB}=200V, I_E=0$				100	μA
Emitter Cutoff Current	I_{EBO} $V_{EB}=6V, I_C=0$				400	mA
DC Current Gain	$h_{FE}(1)$ $V_{CE}=1V, I_C=1A$		15			
	$h_{FE}(2)$ $V_{CE}=1V, I_C=5A$		8	40		
Gain Bandwidth Product	f_T $V_{CE}=10V, I_C=0.5A$		10	40		MHz
C-E Saturation Voltage	$V_{CE(sat)}$ $I_C=5A, I_B=0.65A$				1	V
B-E Saturation Voltage	$V_{BE(sat)}$ $I_C=5A, I_B=0.65A$				1.3	V
C-B Breakdown Voltage	$V(BR)_{CBO}$ $I_C=1mA, I_E=0$	330				V
Diode Forward Voltage	V_F $I_F=5A$				1.5	V
Fall Time	t_f $I_C=5A, I_{B1}=-I_{B2}=0.625A$				0.5	us

Switching Time Test Circuit

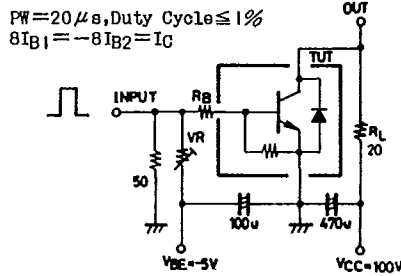

Case Outline 2010A (unit:mm)

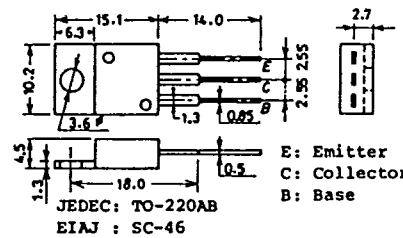

4217KI/3085KI/5053KI, MT No.1310-1/2

2SC3174

T-33-11

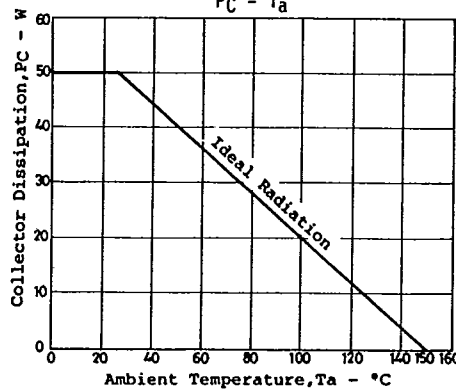
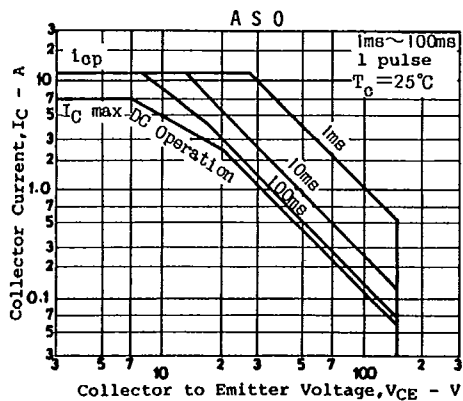
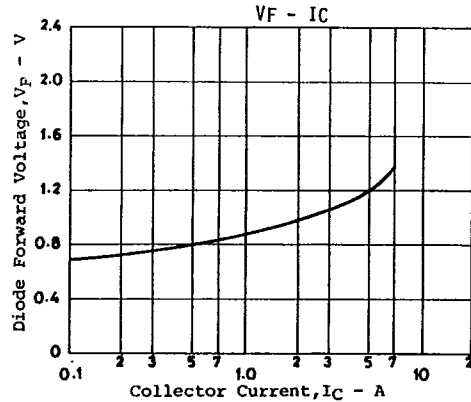
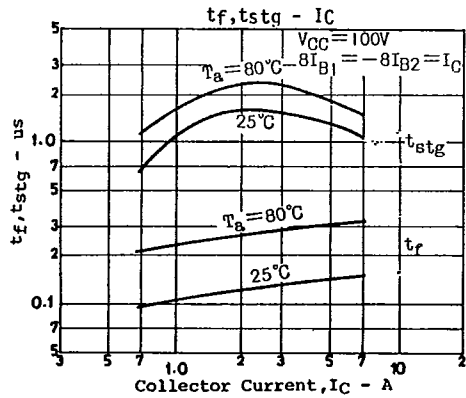
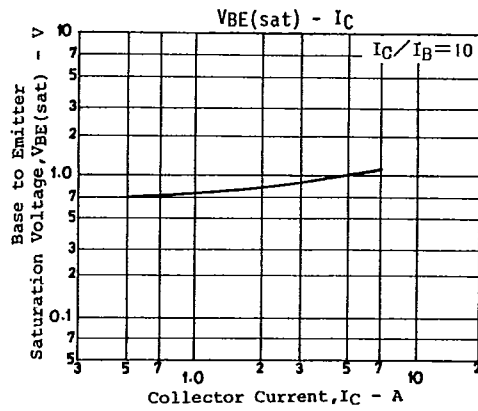
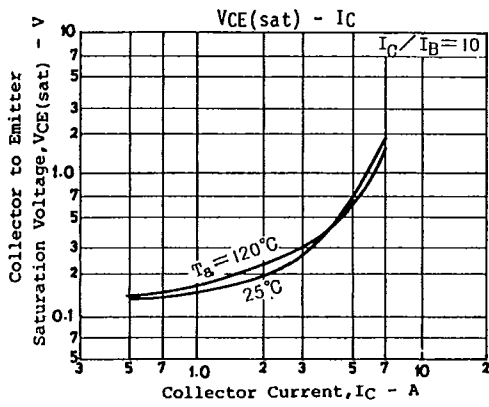
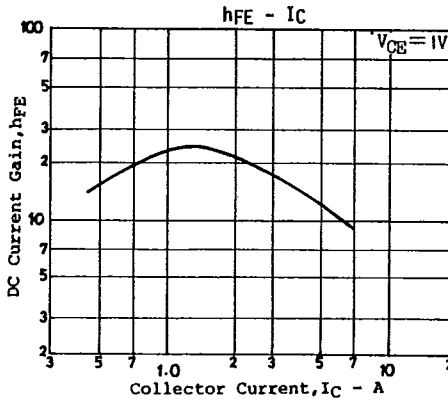
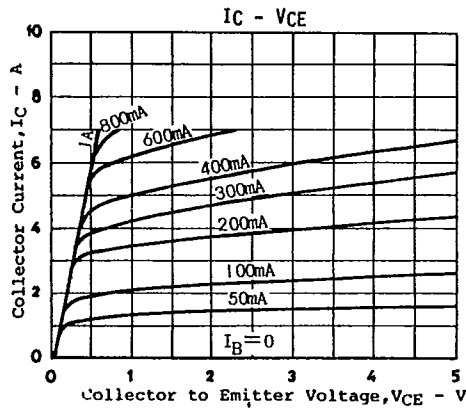

T-91-20

CASE OUTLINES AND ATTACHMENTS

- All of Sanyo Transistor case outlines are illustrated below.
- All dimensions are in mm, and dimensions which are not followed by min. or max. are represented by typical values.
- No marking is indicated.

Case Outline-[2003A]
unit:mm

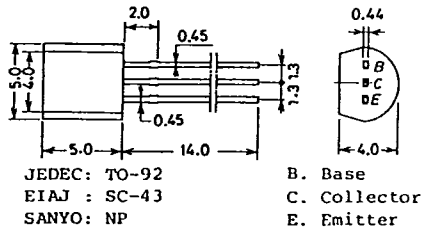

Case Outline-[2009A]
unit:mm

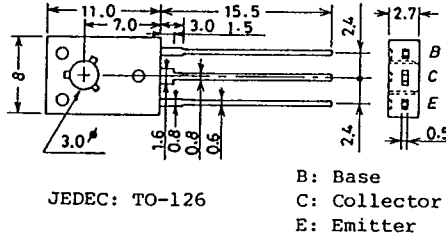

Case Outline-[2004A]
unit:mm

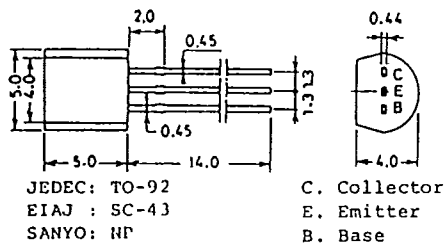

Case Outline-[2010A]
unit:mm

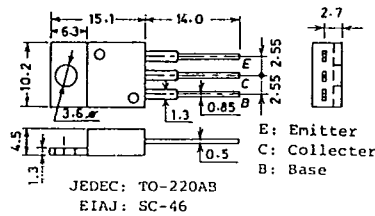

Case Outline-[2005A]
unit:mm

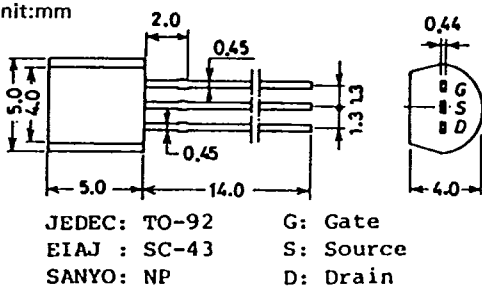

Case Outline-[2012]
unit:mm

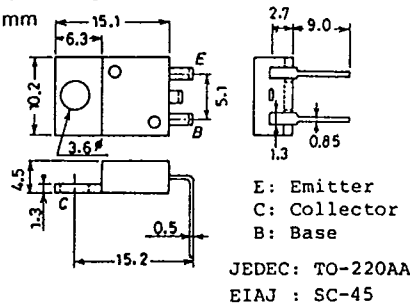

Case Outline-[2006A]
unit:mm

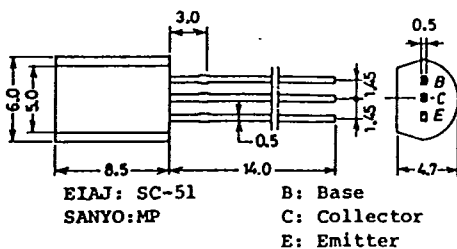

Case Outline-[2013]
unit:mm

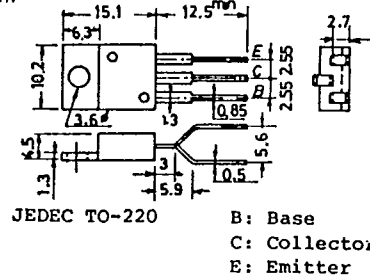

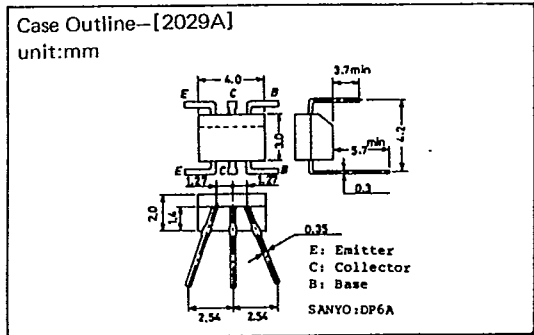
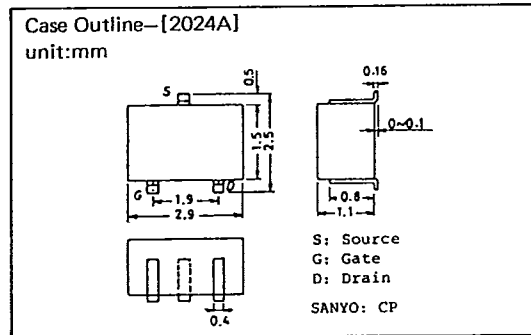
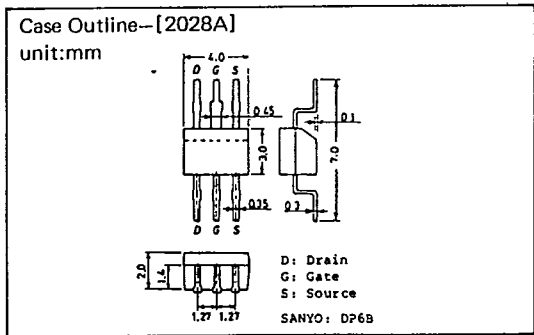
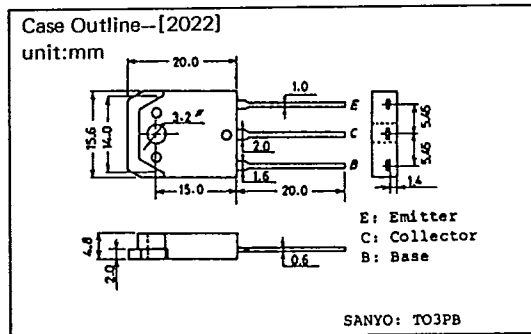
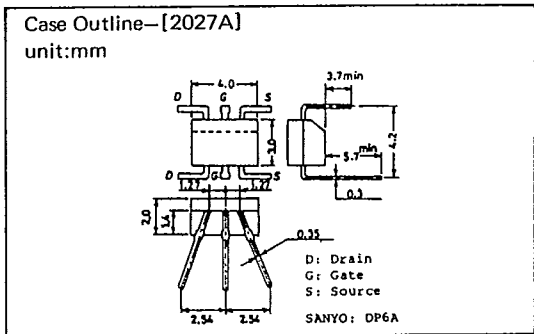
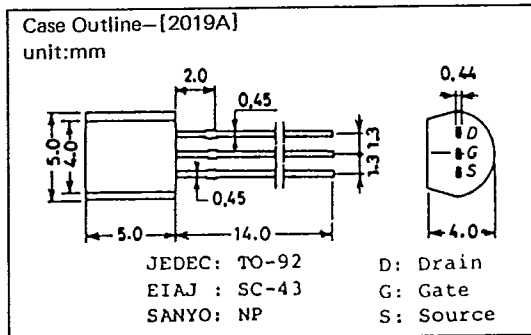
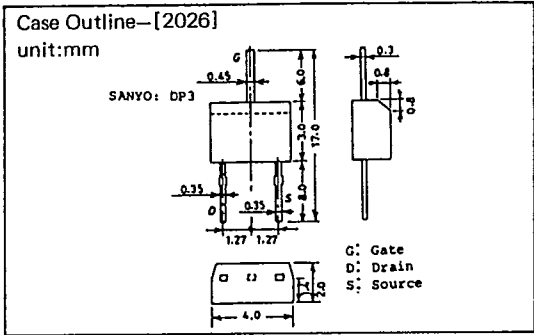
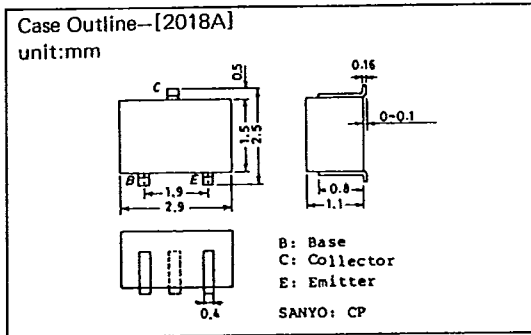
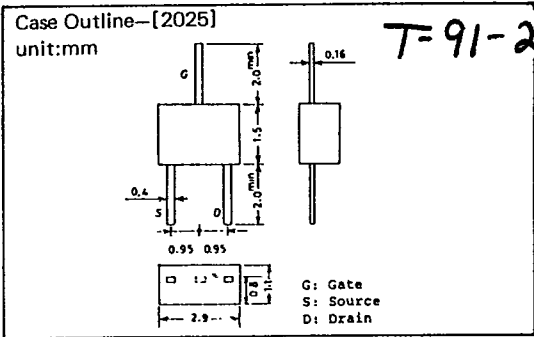
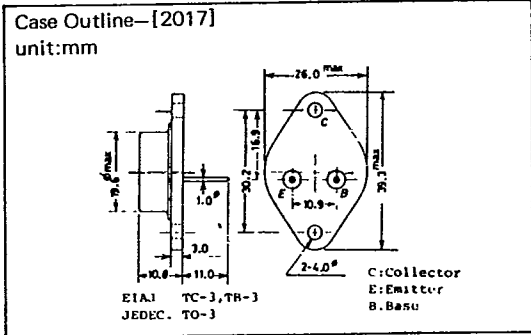

T-91-20

