

Silicon NPN Power Transistors

2SC3680

DESCRIPTION

- With TO-3PN package
- High voltage switching transistor

APPLICATIONS

- Switching regulator and general purpose applications

PINNING

PIN	DESCRIPTION
1	Base
2	Collector;connected to mounting base
3	Emitter

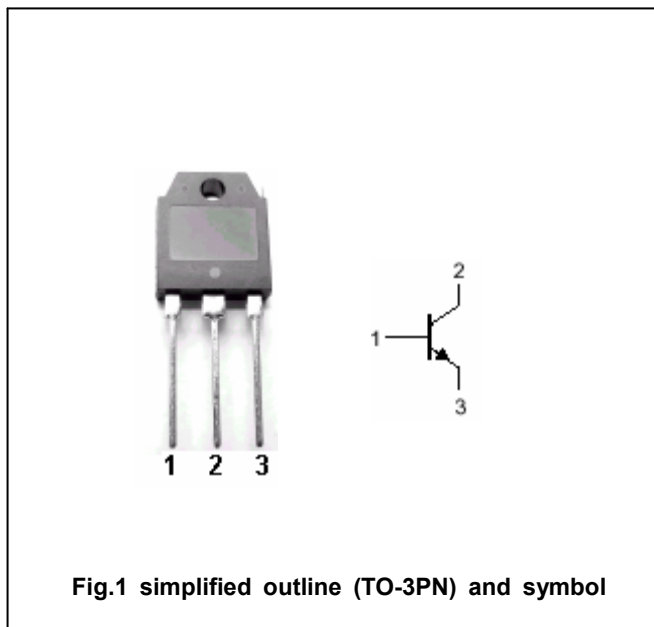

Fig.1 simplified outline (TO-3PN) and symbol

Absolute maximum ratings(Ta=□)

SYMBOL	PARAMETER	CONDITIONS	VALUE	UNIT
V _{CBO}	Collector-base voltage	Open emitter	900	V
V _{CEO}	Collector-emitter voltage	Open base	800	V
V _{EBO}	Emitter-base voltage	Open collector	7	V
I _C	Collector current		7	A
I _{CM}	Collector current-peak		14	A
I _B	Base current		3.5	A
P _C	Collector power dissipation	T _C =25□	120	W
T _j	Junction temperature		150	□
T _{stg}	Storage temperature		-55~150	□

Silicon NPN Power Transistors

2SC3680

CHARACTERISTICS

T_j=25°C unless otherwise specified

SYMBOL	PARAMETER	CONDITIONS	MIN	TYP.	MAX	UNIT
V _{(BR)CEO}	Collector-emitter breakdown voltage	I _C =10mA ; I _B =0	800			V
V _{CEsat}	Collector-emitter saturation voltage	I _C =3A , I _B =0.6A			0.5	V
V _{BEsat}	Base-emitter saturation voltage	I _C =3A ; I _B =0.6A			1.2	V
I _{CBO}	Collector cut-off current	V _{CB} =800V; I _E =0			100	μA
I _{EBO}	Emitter cut-off current	V _{EB} =7V; I _C =0			100	μA
h _{FE}	DC current gain	I _C =3A ; V _{CE} =4V	10		30	
C _{ob}	Output capacitance	I _E =0 ; V _{CB} =10V; f=1MHz		105		pF
f _T	Transition frequency	I _C =2A ; V _{CE} =12V		6		MHz

Switching times

t _{on}	Turn-on time	I _C =3A; I _{B1} =0.45A; I _{B2} =-1.5A; R _L =83Ω V _{CC} =250V			1.0	μs
t _{stg}	Storage time				5.0	μs
t _f	Fall time				1.0	μs

Silicon NPN Power Transistors

2SC3680

PACKAGE OUTLINE

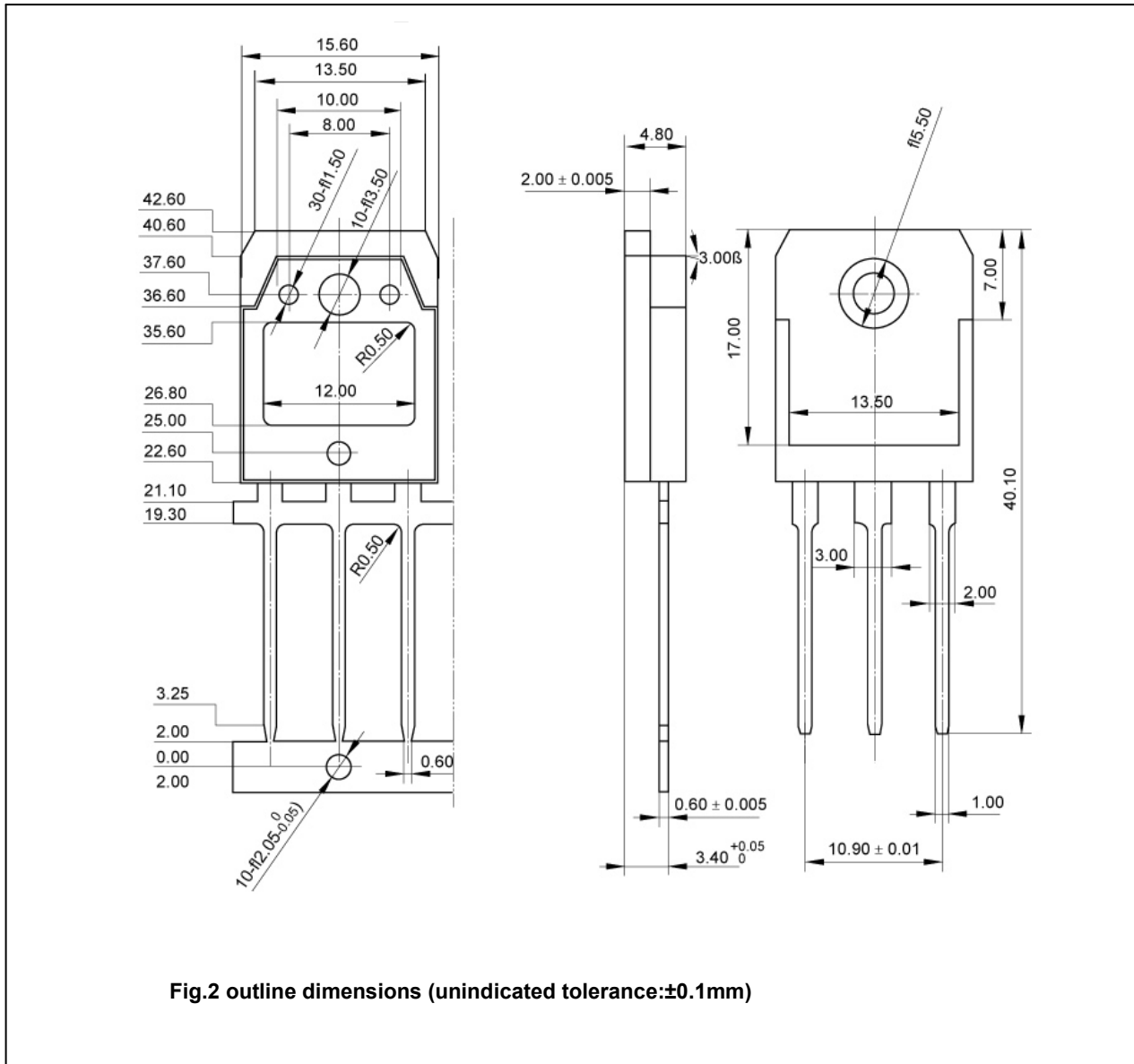

Fig.2 outline dimensions (unindicated tolerance:±0.1mm)

Silicon NPN Power Transistors

2SC3680

www.DataSheet4U.com

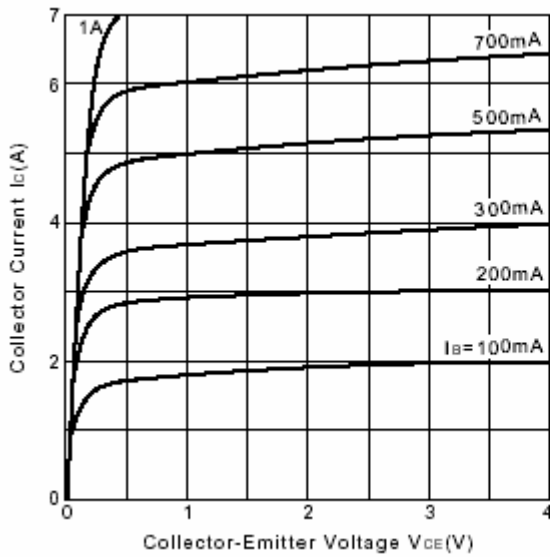

Fig.3 Static Characteristic

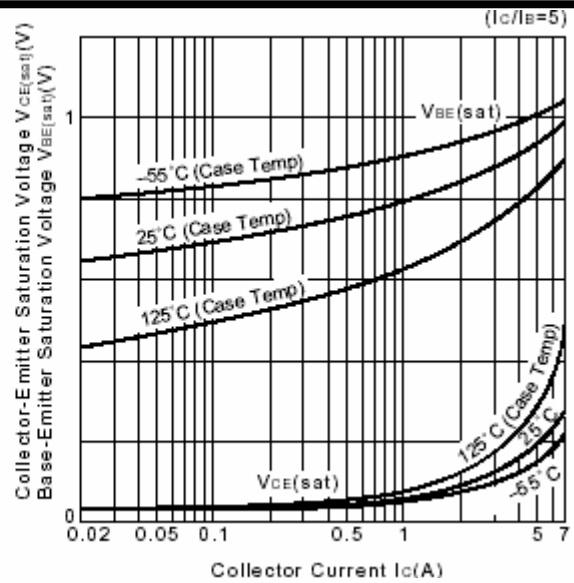

Fig.4 Base-Emitter Saturation Voltage
Collector-Emitter Saturation Voltage

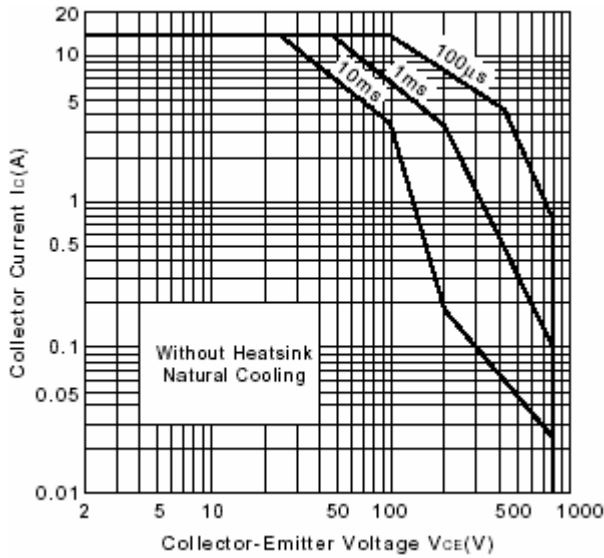

Fig.5 Safe Operating Area

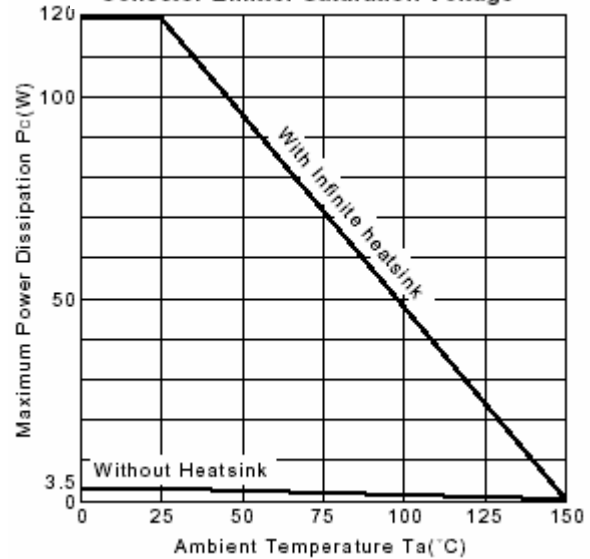

Fig.6 Power Derating

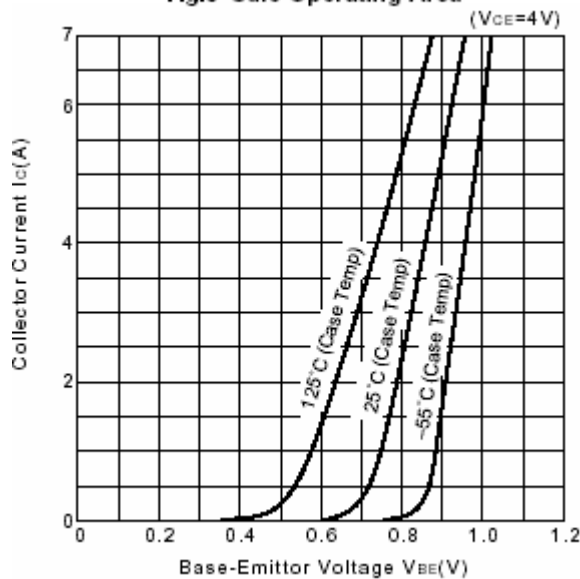

Fig.7 $I_c - V_{BE}$

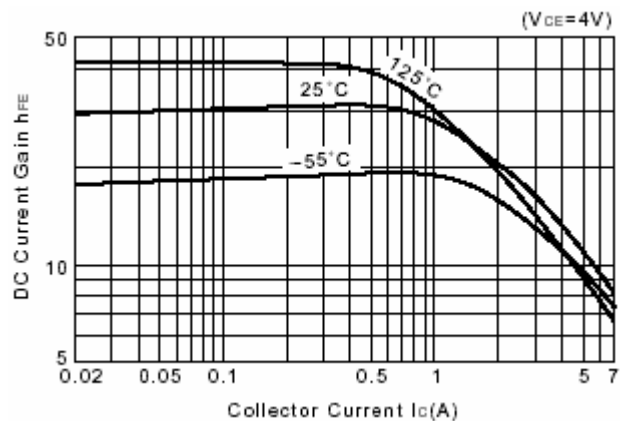

Fig.8 DC current Gain