

Silicon NPN Power Transistors

2SC3685

DESCRIPTION

- With TO-3PN package
- High breakdown voltage
- High reliability
- Fast speed

APPLICATIONS

- Ultrahigh-definition CRT display horizontal deflection output applications

PINNING

PIN	DESCRIPTION
1	Base
2	Collector;connected to mounting base
3	Emitter

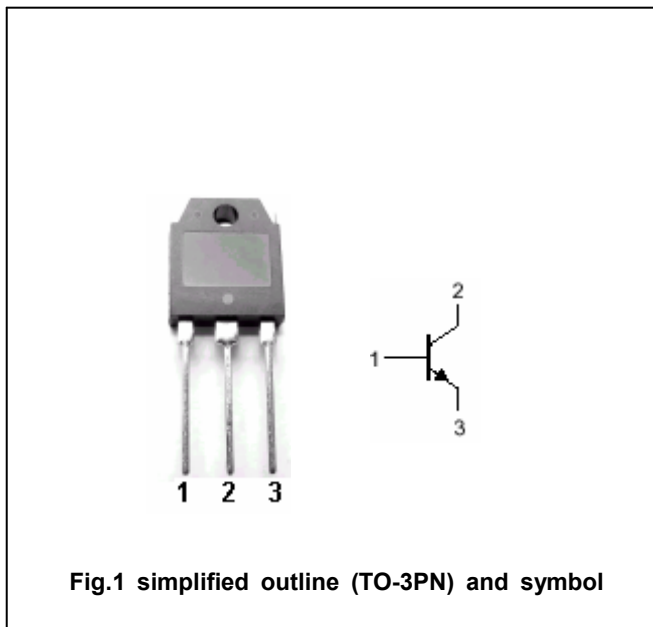

Fig.1 simplified outline (TO-3PN) and symbol

Absolute maximum ratings(Ta=□)

SYMBOL	PARAMETER	CONDITIONS	VALUE	UNIT
V <sub>CBO</sub>	Collector-base voltage	Open emitter	1500	V
V <sub>CEO</sub>	Collector-emitter voltage	Open base	800	V
V <sub>EBO</sub>	Emitter-base voltage	Open collector	6	V
I <sub>C</sub>	Collector current		6	A
I <sub>CP</sub>	Collector current-pulse		16	A
P <sub>C</sub>	Collector power dissipation	T <sub>C</sub> =25□	125	W
T <sub>j</sub>	Junction temperature		150	□
T <sub>stg</sub>	Storage temperature		-55~150	□

## Silicon NPN Power Transistors

## 2SC3685

## CHARACTERISTICS

T<sub>j</sub>=25°C unless otherwise specified

SYMBOL	PARAMETER	CONDITIONS	MIN	TYP.	MAX	UNIT
V <sub>CEO(SUS)</sub>	Collector-emitter sustaining voltage	I <sub>C</sub> =100mA; I <sub>B</sub> =0	800			V
V <sub>CEsat</sub>	Collector-emitter saturation voltage	I <sub>C</sub> =4A; I <sub>B</sub> =1A			5	V
V <sub>BEsat</sub>	Base-emitter saturation voltage	I <sub>C</sub> =4A; I <sub>B</sub> =1A			1.5	V
I <sub>CES</sub>	Collector cut-off current	V <sub>CE</sub> =1500V; R <sub>BE</sub> =0			1	mA
I <sub>EBO</sub>	Emitter cut-off current	V <sub>EB</sub> =4V; I <sub>C</sub> =0			1	mA
h <sub>FE</sub>	DC current gain	I <sub>C</sub> =1A; V <sub>CE</sub> =5V	8			

## Switching times

t <sub>stg</sub>	Storage time	I <sub>C</sub> =4A; I <sub>B1</sub> =0.8A; I <sub>B2</sub> =-1.6A V <sub>CC</sub> =200V			3.0	μs
t <sub>f</sub>	Fall time			0.1	0.2	μs

Silicon NPN Power Transistors

2SC3685

PACKAGE OUTLINE

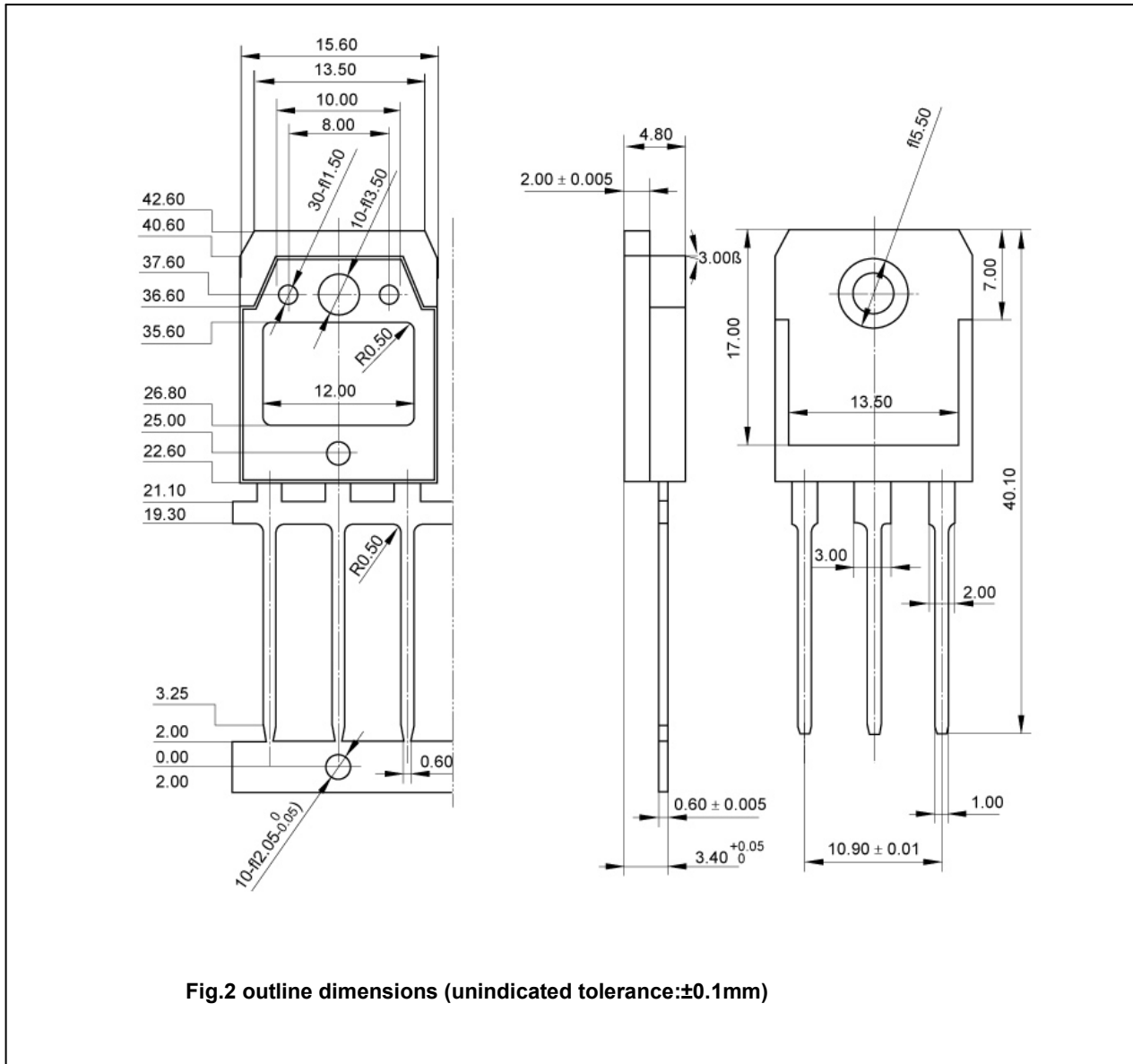

Fig.2 outline dimensions (unindicated tolerance:±0.1mm)

Silicon NPN Power Transistors

2SC3685

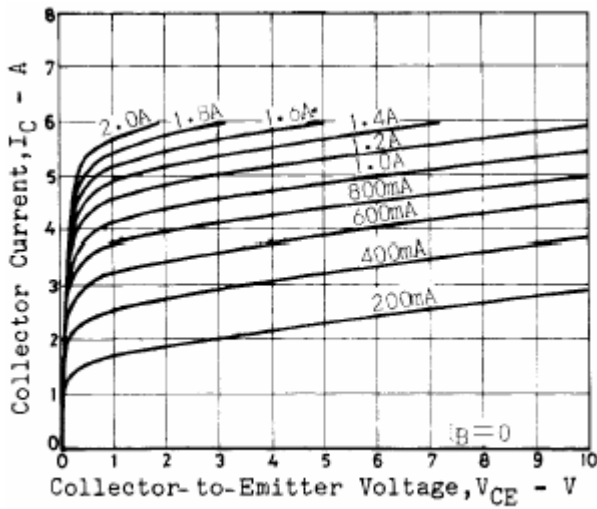

Fig.3 Static Characteristic

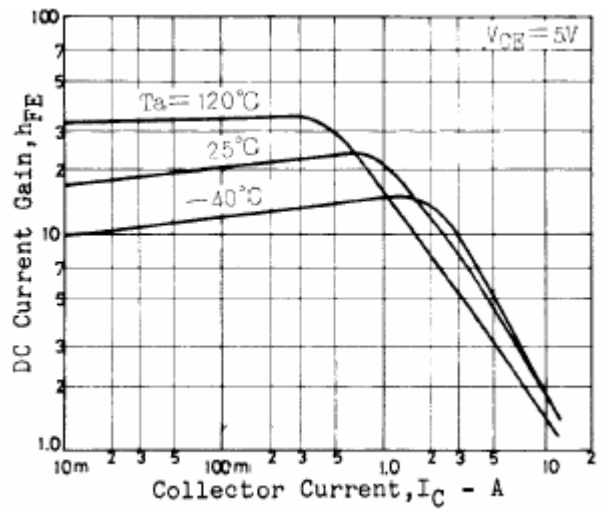

Fig.4 DC current Gain

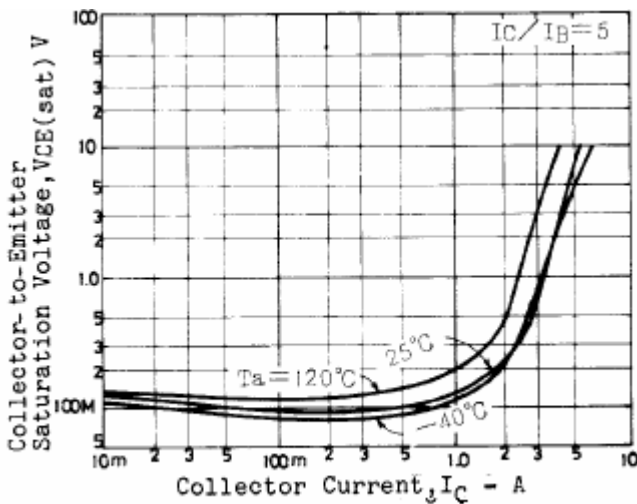

Fig.5 Collector-Emitter Saturation Voltage

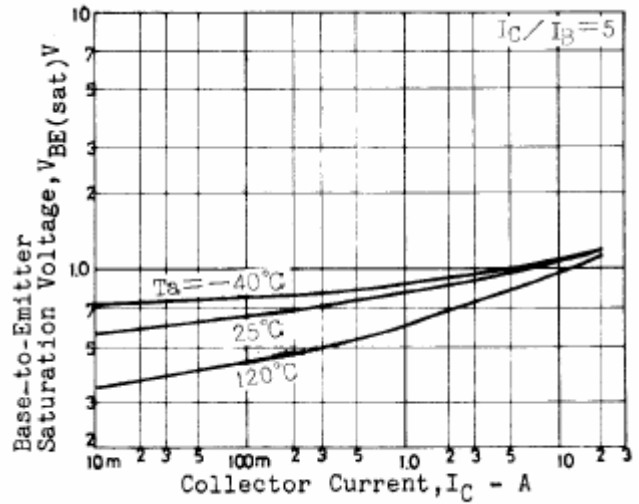

Fig.6 Base-Emitter Saturation Voltage

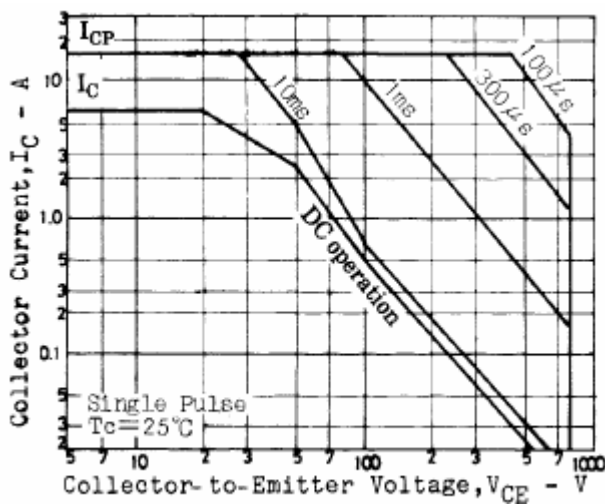

Fig.7 Safe Operating Area