

TOSHIBA Transistor Silicon NPN Epitaxial Type

2SC3964

Switching Applications

Solenoid Drive Applications

Temperature Compensated for Audio Amplifier Output Stage

Industrial Applications

Unit: mm

- High DC current gain: $h_{FE} = 500$ (min) ($I_C = 400$ mA)
- Low collector-emitter saturation voltage: $V_{CE(sat)} = 0.5$ V (max) ($I_C = 300$ mA)

Maximum Ratings ($T_c = 25^\circ\text{C}$)

Characteristics	Symbol	Rating	Unit
Collector-base voltage	V_{CBO}	40	V
Collector-emitter voltage	V_{CEO}	40	V
Emitter-base voltage	V_{EBO}	7	V
Collector current	I_C	2	A
Base current	I_B	0.5	A
Collector power dissipation	P_C	1.5	W
Junction temperature	T_j	150	$^\circ\text{C}$
Storage temperature range	T_{stg}	-55 to 150	$^\circ\text{C}$

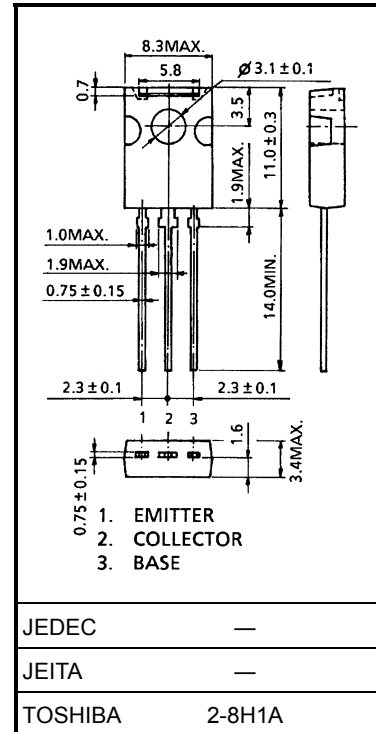

Weight: 0.82 g (typ.)

Electrical Characteristics ($T_c = 25^\circ\text{C}$)

Characteristics	Symbol	Test Condition	Min	Typ.	Max	Unit
Collector cut-off current	I_{CBO}	$V_{CB} = 40$ V, $I_E = 0$	—	—	10	μA
Emitter cut-off current	I_{EBO}	$V_{EB} = 7$ V, $I_C = 0$	—	—	1	μA
Collector-emitter breakdown voltage	$V_{(BR)CEO}$	$I_C = 10$ mA, $I_B = 0$	40	—	—	V
DC current gain	h_{FE}	$V_{CE} = 1$ V, $I_C = 400$ mA	500	—	—	
Collector-emitter saturation voltage	$V_{CE(sat)}$	$I_C = 300$ mA, $I_B = 1$ mA	—	0.3	0.5	V
Base-emitter saturation voltage	$V_{BE(sat)}$	$I_C = 300$ mA, $I_B = 1$ mA	—	—	1.1	V
Transition frequency	f_T	$V_{CE} = 2$ V, $I_C = 100$ mA	—	220	—	MHz
Collector output capacitance	C_{ob}	$V_{CB} = 10$ V, $I_B = 0$, $f = 1$ MHz	—	20	—	pF
Switching time	Turn-on time	t_{on}	—	1.0	—	μs
	Storage time	t_{stg}	—	3.0	—	
	Fall time	t_f	—	1.2	—	

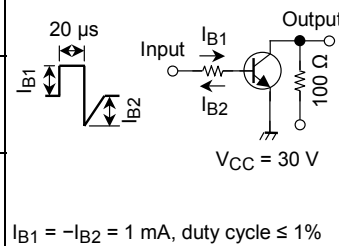

Marking

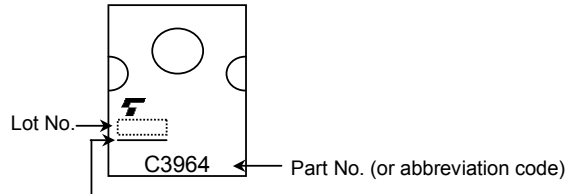

A line indicates
lead (Pb)-free package or
lead (Pb)-free finish.

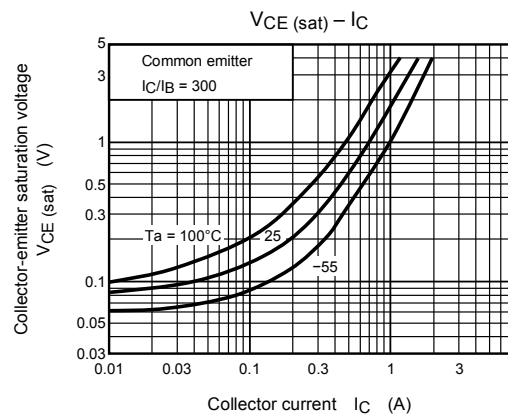
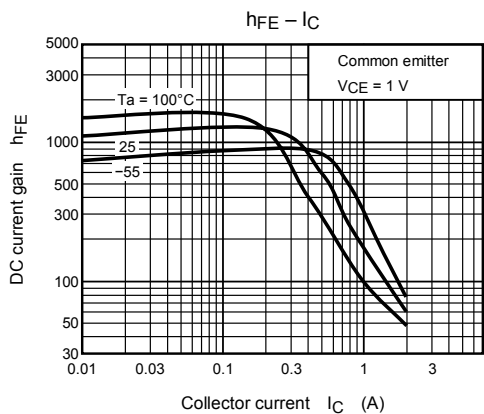
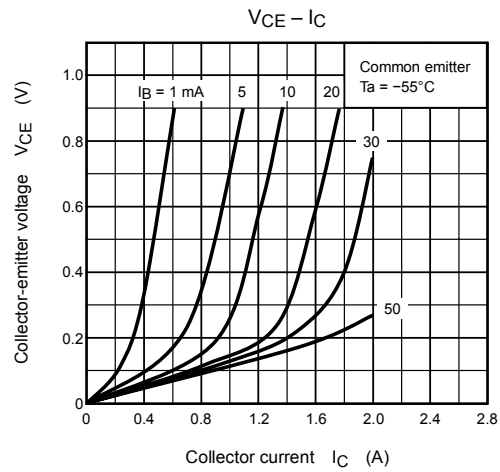
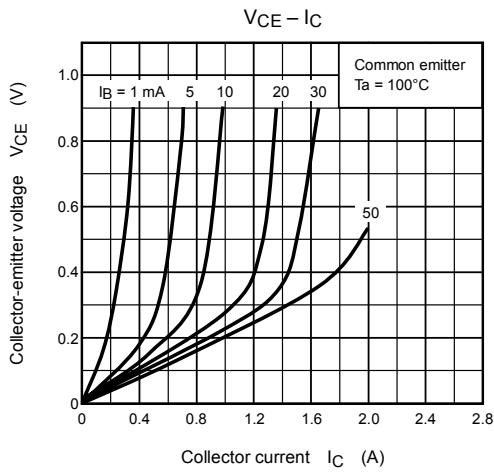
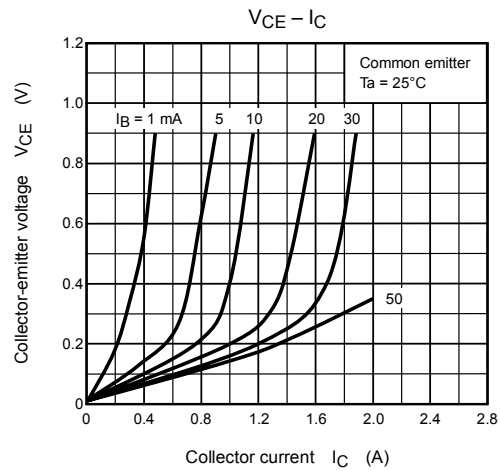
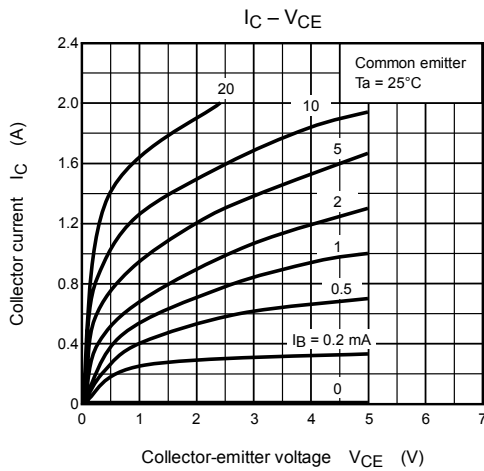

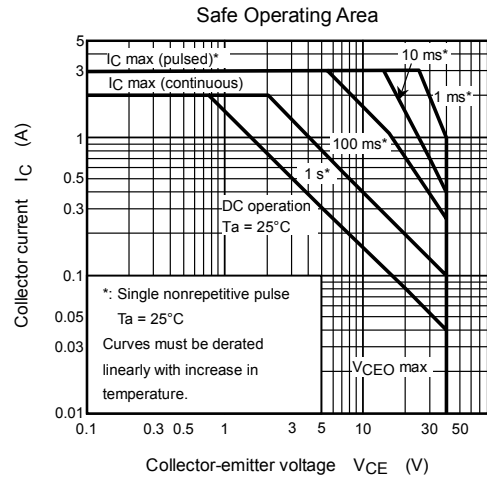
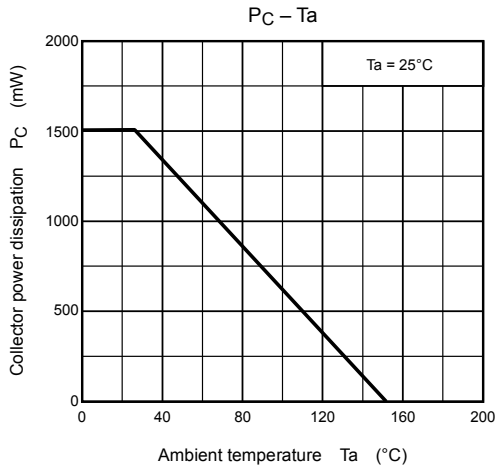
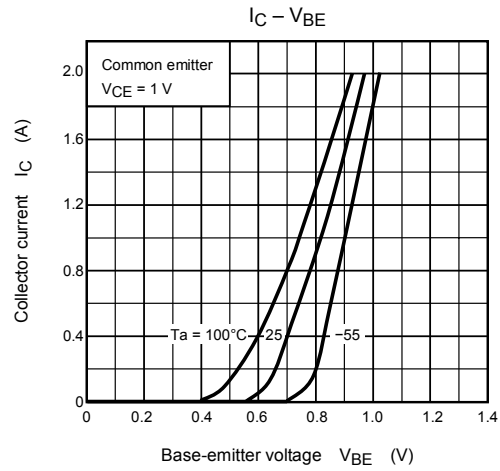
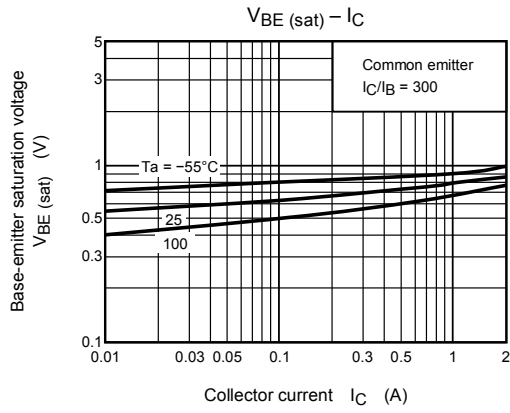

RESTRICTIONS ON PRODUCT USE

030619EAA

- The information contained herein is subject to change without notice.
- The information contained herein is presented only as a guide for the applications of our products. No responsibility is assumed by TOSHIBA for any infringements of patents or other rights of the third parties which may result from its use. No license is granted by implication or otherwise under any patent or patent rights of TOSHIBA or others.
- TOSHIBA is continually working to improve the quality and reliability of its products. Nevertheless, semiconductor devices in general can malfunction or fail due to their inherent electrical sensitivity and vulnerability to physical stress. It is the responsibility of the buyer, when utilizing TOSHIBA products, to comply with the standards of safety in making a safe design for the entire system, and to avoid situations in which a malfunction or failure of such TOSHIBA products could cause loss of human life, bodily injury or damage to property.
In developing your designs, please ensure that TOSHIBA products are used within specified operating ranges as set forth in the most recent TOSHIBA products specifications. Also, please keep in mind the precautions and conditions set forth in the "Handling Guide for Semiconductor Devices," or "TOSHIBA Semiconductor Reliability Handbook" etc..
- The TOSHIBA products listed in this document are intended for usage in general electronics applications (computer, personal equipment, office equipment, measuring equipment, industrial robotics, domestic appliances, etc.). These TOSHIBA products are neither intended nor warranted for usage in equipment that requires extraordinarily high quality and/or reliability or a malfunction or failure of which may cause loss of human life or bodily injury ("Unintended Usage"). Unintended Usage include atomic energy control instruments, airplane or spaceship instruments, transportation instruments, traffic signal instruments, combustion control instruments, medical instruments, all types of safety devices, etc.. Unintended Usage of TOSHIBA products listed in this document shall be made at the customer's own risk.
- TOSHIBA products should not be embedded to the downstream products which are prohibited to be produced and sold, under any law and regulations.