

Silicon NPN Power Transistors

2SC4106

DESCRIPTION

- With TO-220C package
- High breakdown voltage and high reliability
- Fast switching speed.
- Wide area of safe operation

APPLICATIONS

- 400V/7A switching regulator applications

PINNING

PIN	DESCRIPTION
1	Base
2	Collector;connected to mounting base
3	Emitter

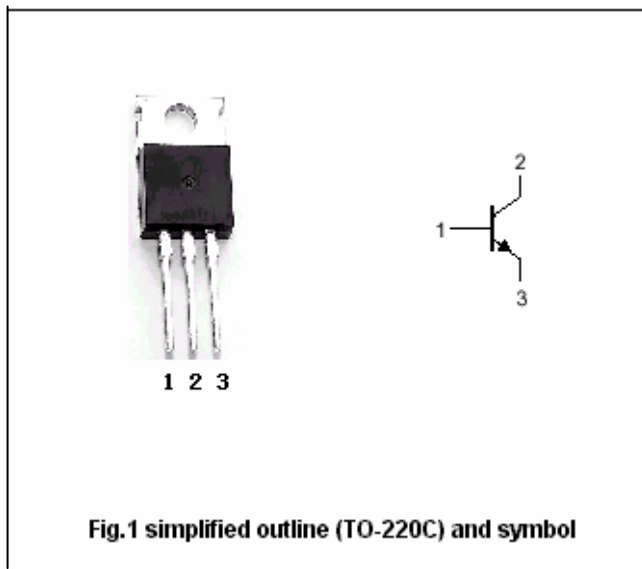

Fig.1 simplified outline (TO-220C) and symbol

Absolute maximum ratings(Ta=25°C)

SYMBOL	PARAMETER	CONDITIONS	VALUE	UNIT
V _{CBO}	Collector-base voltage	Open emitter	500	V
V _{CEO}	Collector-emitter voltage	Open base	400	V
V _{EBO}	Emitter-base voltage	Open collector	7	V
I _C	Collector current		7	A
I _{CM}	Collector current-peak		14	A
I _B	Base current		3	A
P _C	Collector dissipation	Ta=25°C	1.75	W
		Tc=25°C	50	
T _j	Junction temperature		150	°C
T _{stg}	Storage temperature		-55~150	°C

Silicon NPN Power Transistors

2SC4106

CHARACTERISTICS

T_j=25 °C unless otherwise specified

SYMBOL	PARAMETER	CONDITIONS	MIN	TYP.	MAX	UNIT
V _{(BR)CEO}	Collector-emitter breakdown voltage	I _C =5mA ; R _{BE} =∞	400			V
V _{(BR)CBO}	Collector-base breakdown voltage	I _C =1mA ; I _E =0	500			V
V _{(BR)EBO}	Emitter-base breakdown voltage	I _E =1mA ; I _C =0	7			V
V _{CEsat}	Collector-emitter saturation voltage	I _C =4A ; I _B =0.8A			0.8	V
V _{BEsat}	Base-emitter saturation voltage	I _C =4A ; I _B =0.8A			1.5	V
I _{CBO}	Collector cut-off current	V _{CB} =400V ; I _E =0			10	μA
I _{EBO}	Emitter cut-off current	V _{EB} =5V ; I _C =0			10	μA
h _{FE-1}	DC current gain	I _C =0.8A ; V _{CE} =5V	15		50	
h _{FE-2}	DC current gain	I _C =4A ; V _{CE} =5V	10			
h _{FE-3}	DC current gain	I _C =10mA ; V _{CE} =5V	10			
f _T	Transition frequency	I _C =0.8A ; V _{CE} =10V		20		MHz
C _{OB}	Collector output capacitance	f=1MHz ; V _{CB} =10V		80		pF

Switching times

t _{on}	Turn-on time	I _C =5A ; I _{B1} =1A ; I _{B2} =-2A ; R _L =40Ω V _{CC} =200V			0.5	μs
t _{stg}	Storage time				2.5	μs
t _f	Fall time				0.3	μs

◆ h_{FE-1} classifications

L	M	N
15-30	20-40	30-50

Silicon NPN Power Transistors

2SC4106

PACKAGE OUTLINE

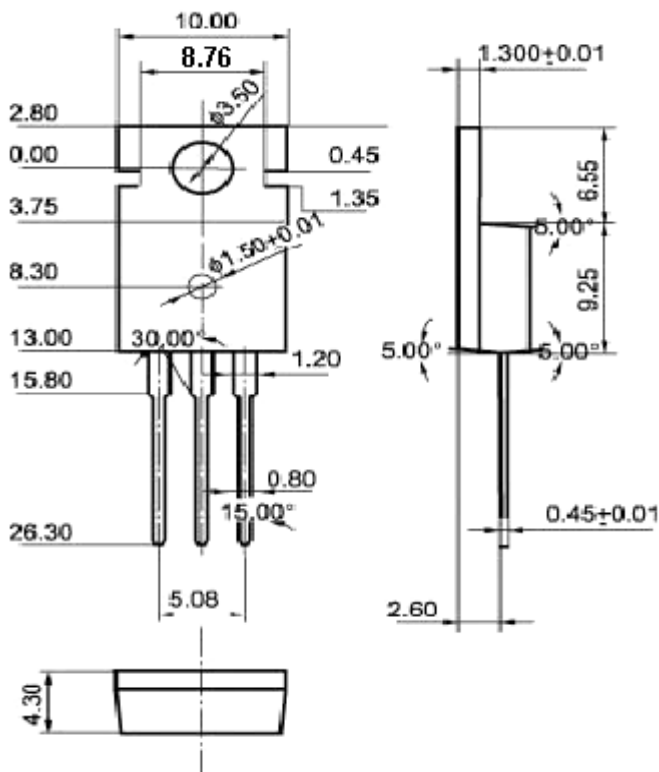

Fig.2 Outline dimensions (unindicated tolerance:±0.10 mm)

Silicon NPN Power Transistors

2SC4106

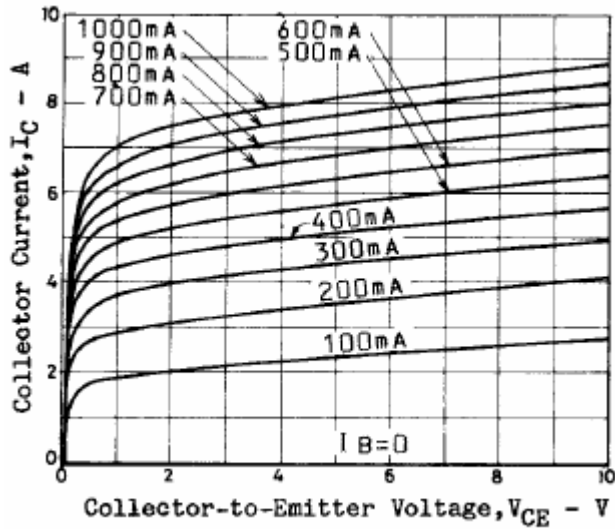

Fig.3 Static Characteristic

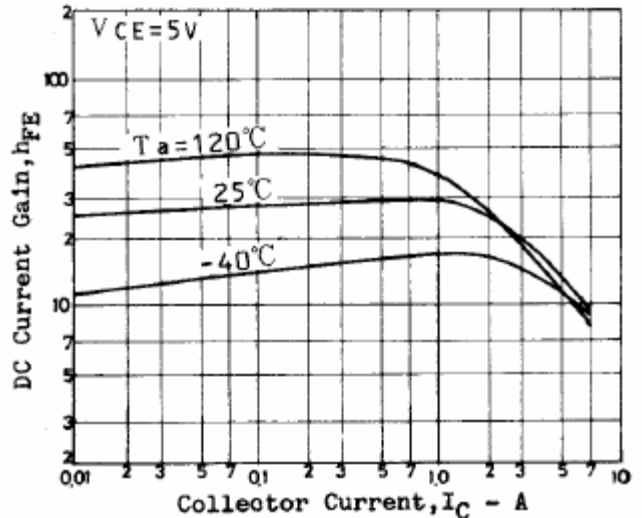

Fig.4 DC current Gain

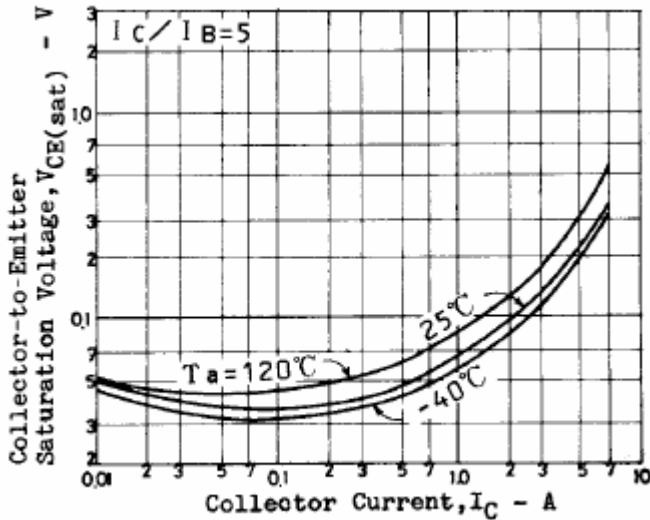

Fig.5 Collector-Emmitter Saturation Voltage

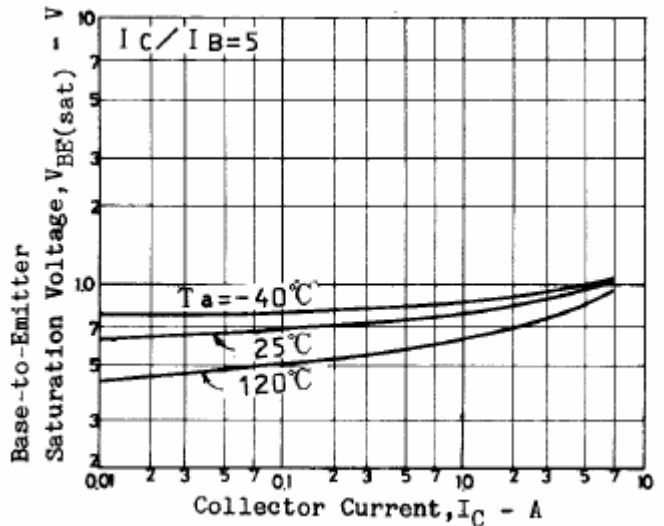

Fig.6 Base-Emmitter Saturation Voltage

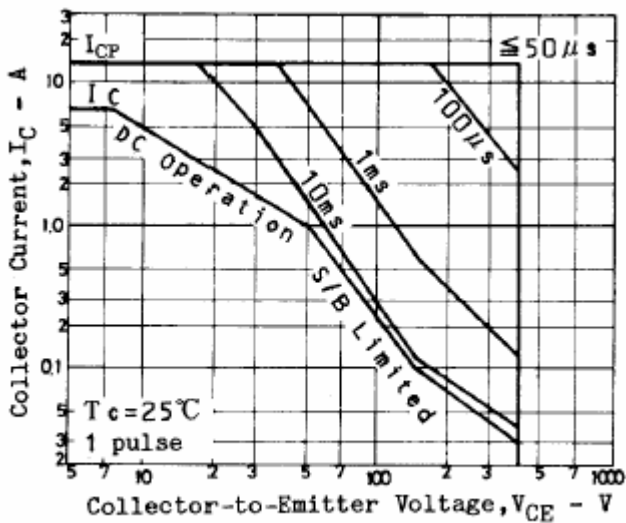

Fig.7 Safe Operating Area