

High Frequency NPN Power Transistor

1A/230V/20W

FEATURES

- High transition frequency:
 $f_T = 100\text{MHz}$ (typ.)
- Complementary to 2SA1837AF
- TO-220F package which can be installed to the heat sink with one screw

APPLICATIONS

- Power amplifier
- Driver stage amplifier

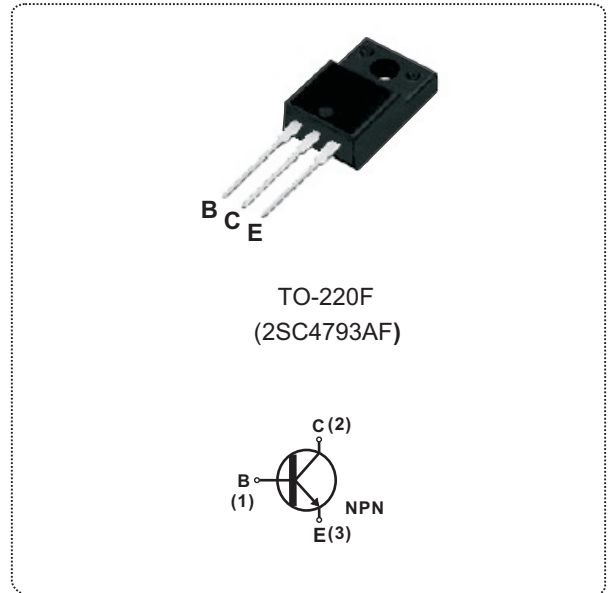
ABSOLUTE MAXIMUM RATINGS ($T_C = 25^\circ\text{C}$ unless otherwise specified)

SYMBOL	PARAMETER	TEST CONDITIONS	VALUE	UNIT
V_{CBO}	Collector to base voltage		230	V
V_{CEO}	Collector to emitter voltage	$I_B=0$	230	
V_{EBO}	Emitter to base voltage	$I_C=0$	5	
I_C	Collector current-continuous		1	A
$I_{CM}(I_{Cp})$	Peak collector current	$t_p < 5\text{ ms}$	2	
I_B	Base Current		0.1	
P_C	Collector power dissipation	$T_C=25^\circ\text{C}$	20	W
		$T_a=25^\circ\text{C}$	2.0	
T_J	Junction temperature		150	$^\circ\text{C}$
T_{STG}	Storage temperature		-55 to 150	

ELECTRICAL CHARACTERISTICS ($T_C = 25^\circ\text{C}$ unless otherwise specified)

SYMBOL	PARAMETER	TEST CONDITIONS	Min.	Typ.	Max.	UNIT
I_{CBO}	Collector cutoff current	$V_{CBO}=230\text{V}, I_E=0$	$T_C=25^\circ\text{C}$		1.0	μA
			$T_C=125^\circ\text{C}$		100	
I_{EBO}	Emitter cutoff current	$V_{EBO}=5\text{V}, I_C=0$			1.0	
$V_{(BR)CEO}$	Collector to emitter breakdown voltage	$I_B=0, I_C=100\text{mA}$	230			V
$V_{CE(sat)*}$	Collector to emitter saturation voltage	$I_C=0.5\text{A}, I_B=50\text{mA}$			1.5	
V_{BE}	Base to emitter voltage	$I_C=0.5\text{A}, V_{CE}=5\text{V}$			1.0	
h_{FE*}	Forward current transfer ratio (DC current gain)	$I_C=0.1\text{A}, V_{CE}=5\text{V}$	100		320	
F_T	Transition frequency	$V_{CE}=10\text{V}, I_C=100\text{mA}$		100		MHz
C_{ob}	Collector output capacitance	$V_{CB}=10\text{V}, I_E=0, f=1\text{MHz}$		20		pF

*Pulsed: Pulse duration= 300 μs , duty cycle= 1.5%.

Fig.1 I_C - V_{CE} Characteristics

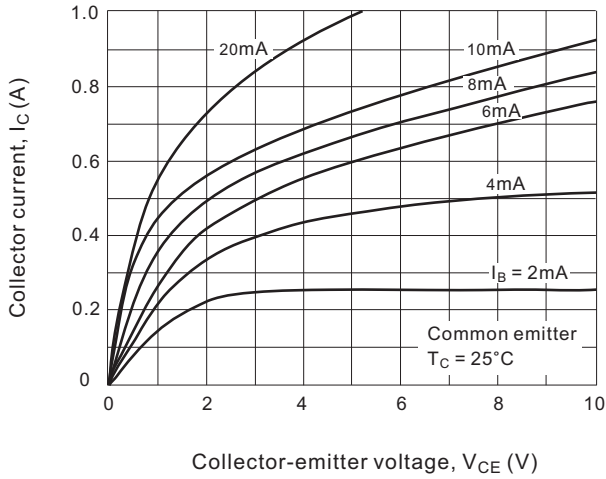

Fig.2 I_C - V_{BE} Temperature characteristics

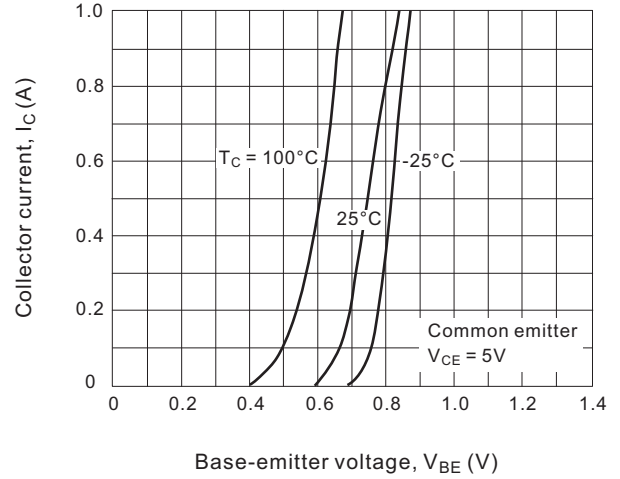

Fig.3 h_{FE} - I_C Characteristics

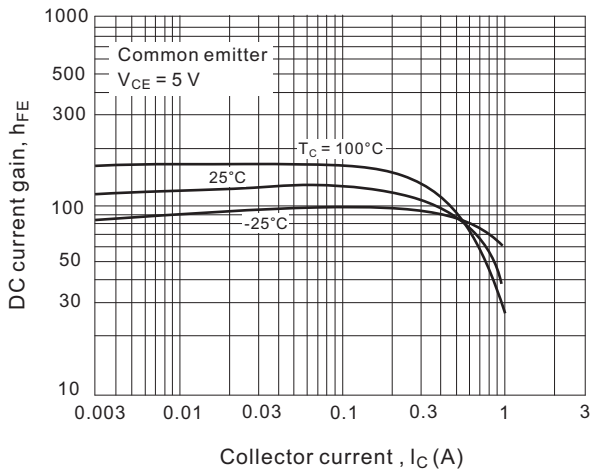

Fig.4 $V_{CE(sat)}$ - I_C Temperature characteristics

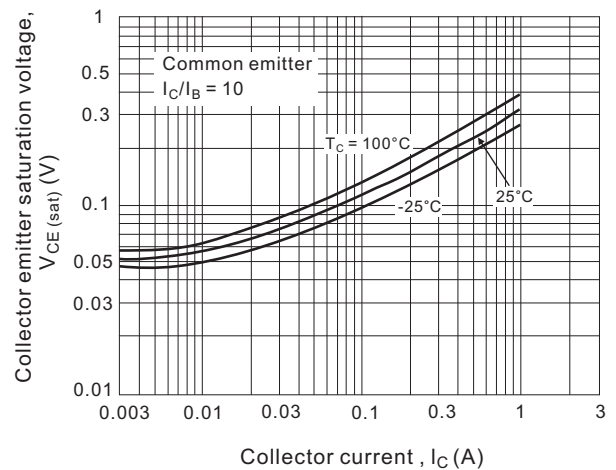

Fig.5 f_T - I_C Characteristics

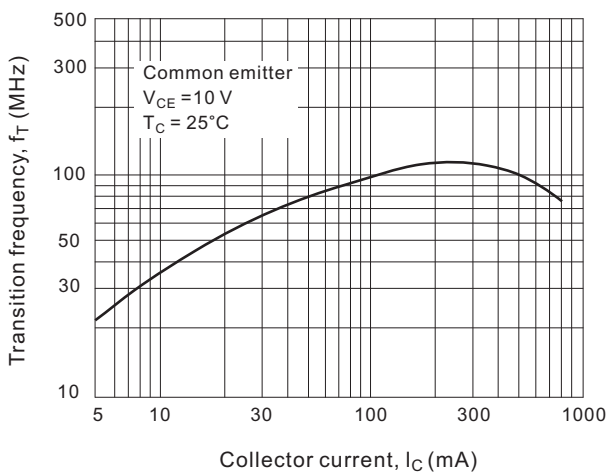
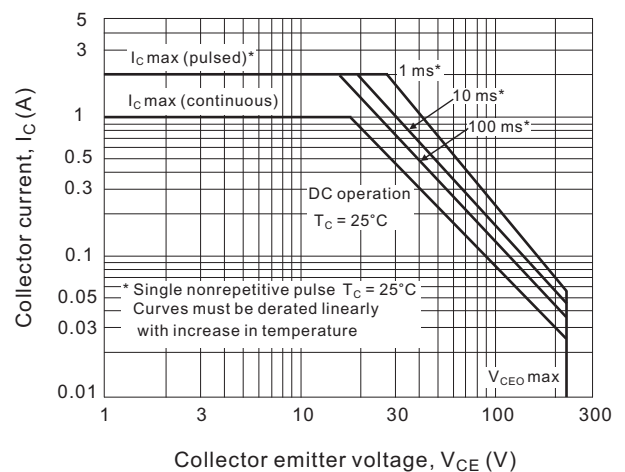
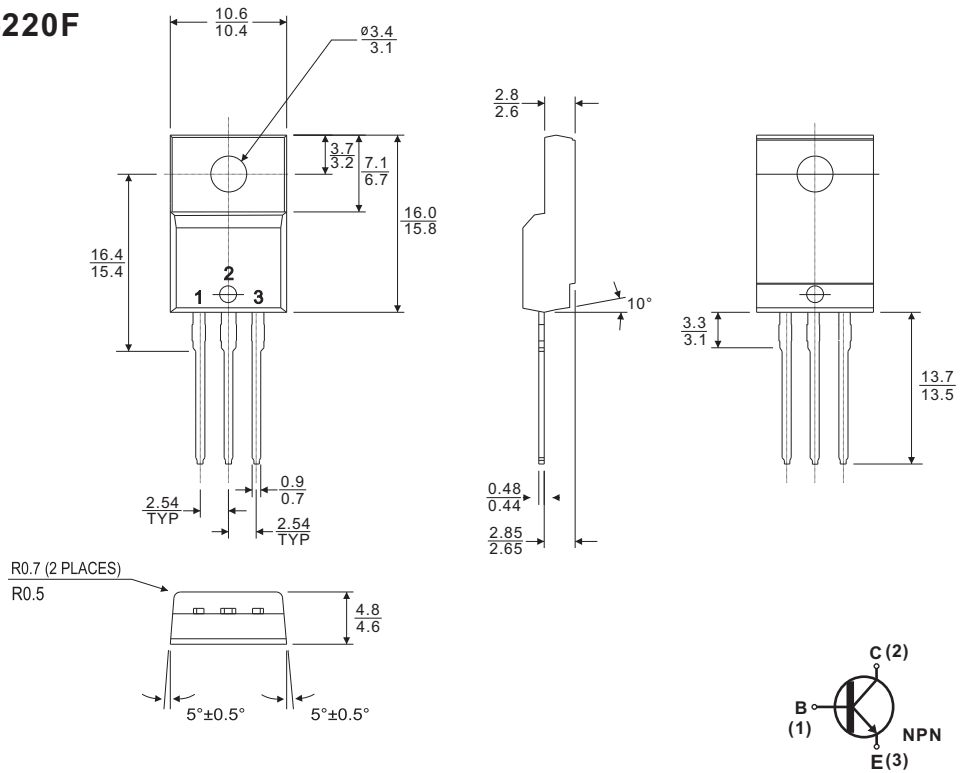

Fig.6 Safe operating area (SOA)



Case Style

TO-220F



All dimensions in millimeters