

Silicon NPN Power Transistors

2SC4927

DESCRIPTION

- With TO-3PFM package
- Built-in damper diode
- High breakdown voltage

APPLICATIONS

- TV/Character display horizontal deflection output applications

PINNING

PIN	DESCRIPTION
1	Base
2	Collector
3	Emitter

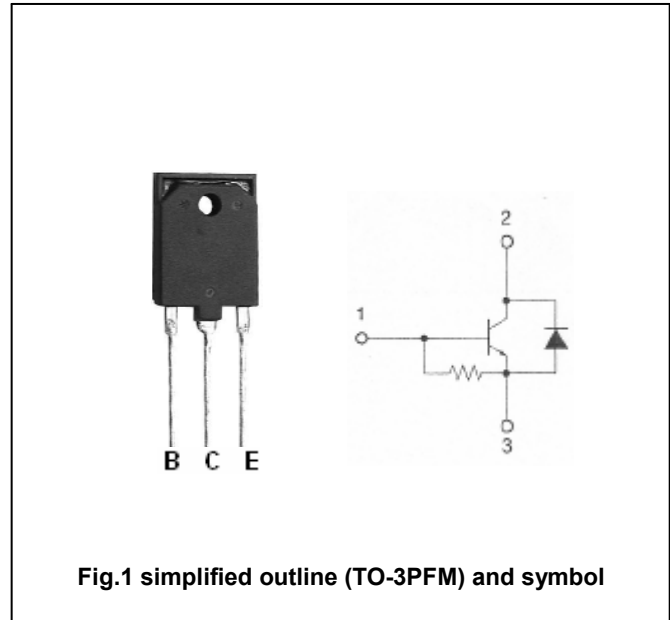

Fig.1 simplified outline (TO-3PFM) and symbol

Absolute maximum ratings($T_a = \square$)

SYMBOL	PARAMETER	CONDITIONS	VALUE	UNIT
V_{CEO}	Collector-emitter voltage	Open base	1500	V
V_{EBO}	Emitter-base voltage	Open collector	6	V
I_C	Collector current		8	A
$I_{C(peak)}$	Collector current-peak		9	A
$I_{C(surge)}$	Collector current-surge		18	A
I_o	C to E diode forward current		8	A
P_C	Collector power dissipation	$T_C = 25 \square$	50	W
T_j	Junction temperature		150	\square
T_{stg}	Storage temperature		-55~150	\square

Silicon NPN Power Transistors

2SC4927

CHARACTERISTICS

T_j=25°C unless otherwise specified

SYMBOL	PARAMETER	CONDITIONS	MIN	TYP.	MAX	UNIT
V _{(BR)EBO}	Emitter-base breakdown voltage	I _E =500mA ; I _C =0	6			V
I _{CES}	Collector cut-off current	V _{CE} =1500V; R _{BE} =0			0.5	mA
h _{FE}	DC current gain	I _C =1A ; V _{CE} =5V			25	
V _{CE(sat)}	Collector-emitter saturation voltage	I _C =6A ; I _B =1.2A			5	V
V _{BE(sat)}	Base-emitter saturation voltage	I _C =6A ; I _B =1.2A			1.5	V
V _{ECF}	Diode forward voltage	I _F =8A			2.0	V
t _f	Fall time	I _{CP} =6A; f _H =31.5kHz I _{B1} =1.2A; I _{B2} =-2.4A			0.5	μs

Silicon NPN Power Transistors

2SC4927

PACKAGE OUTLINE

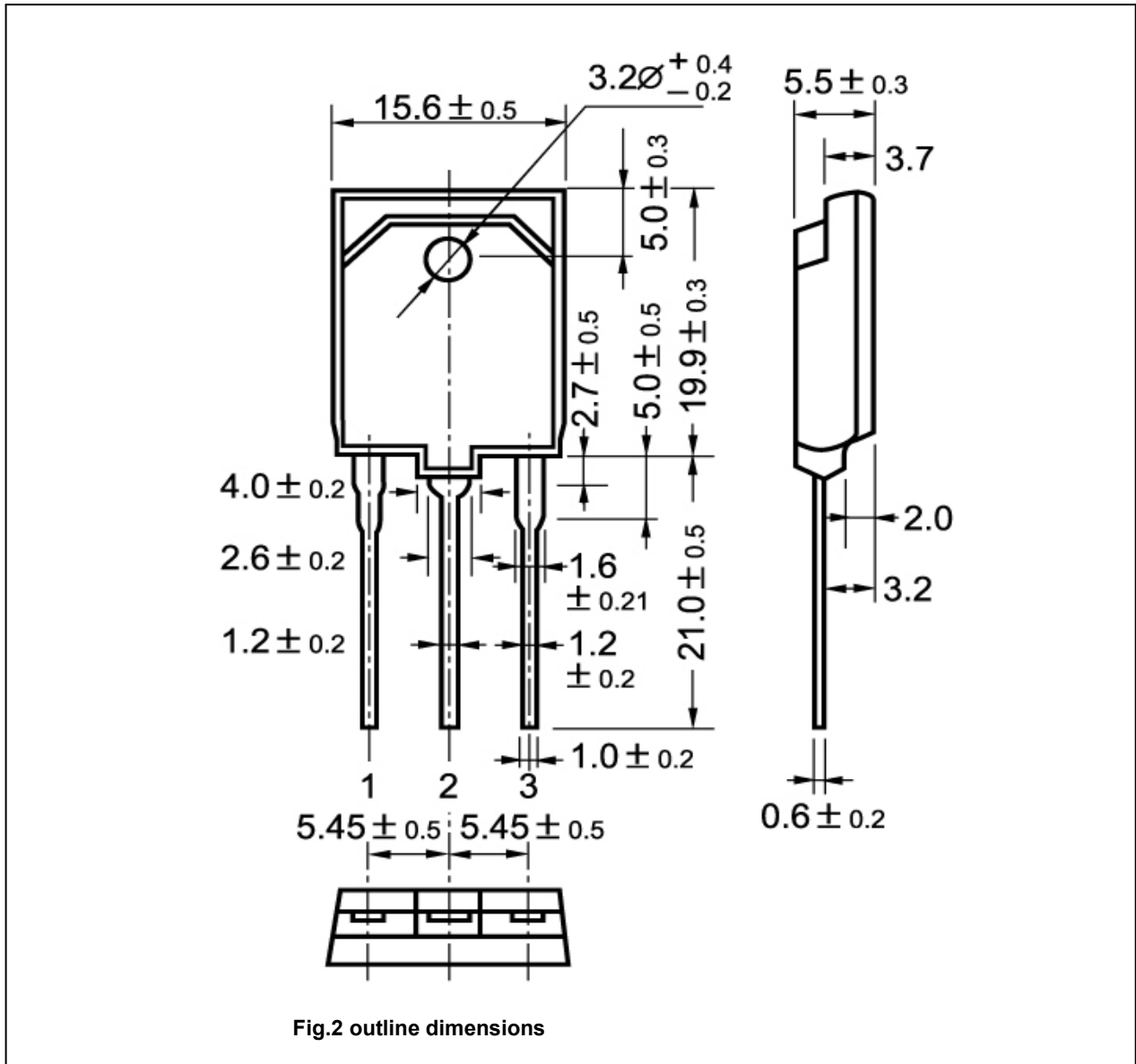

Silicon NPN Power Transistors

2SC4927

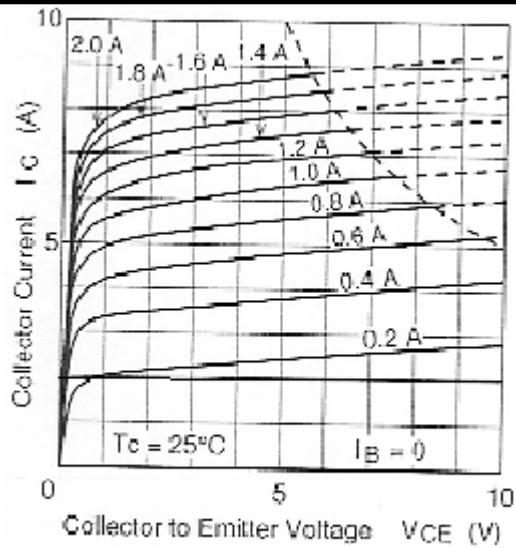

Fig.3 Static Characteristic

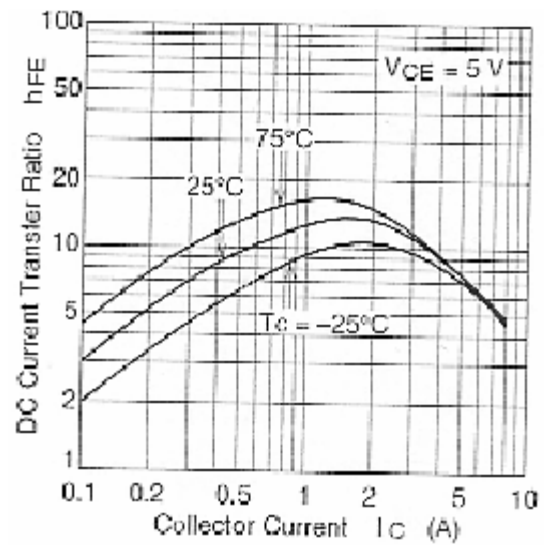

Fig.4 DC current Gain

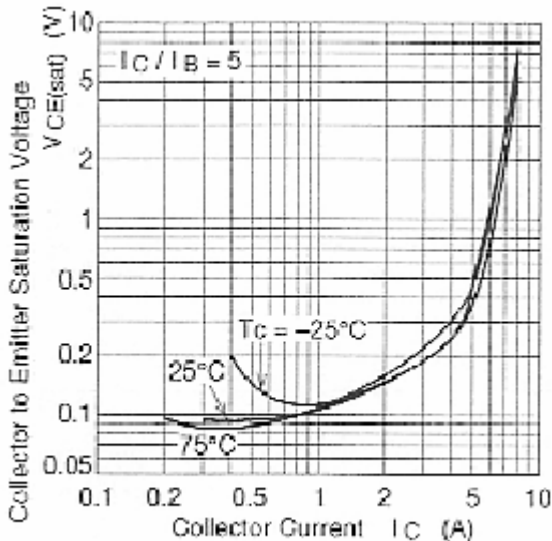

Fig.5 Collector-Emitter Saturation Voltage

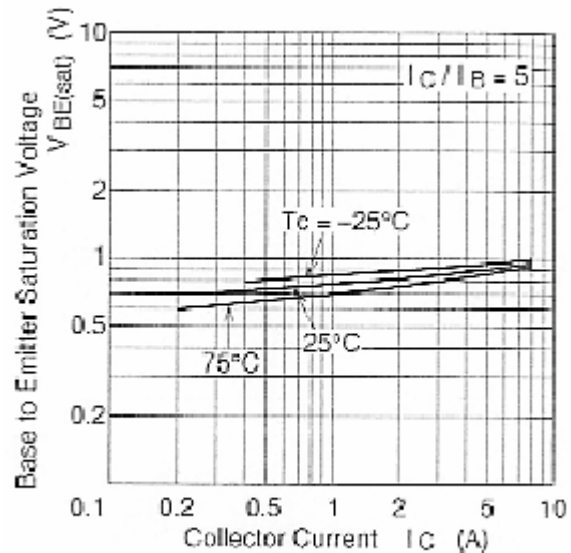

Fig.6 Base-Emitter Saturation Voltage

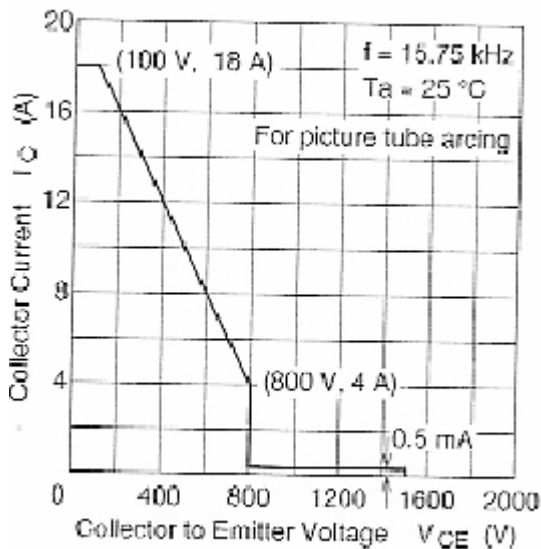

Fig.7 Safe Operating Area