

Silicon NPN Power Transistors

2SC5071

DESCRIPTION

- With TO-3PN package
- High voltage
- High speed switching

APPLICATIONS

- For switching regulator and general purpose applications

PINNING

PIN	DESCRIPTION
1	Base
2	Collector;connected to mounting base
3	Emitter

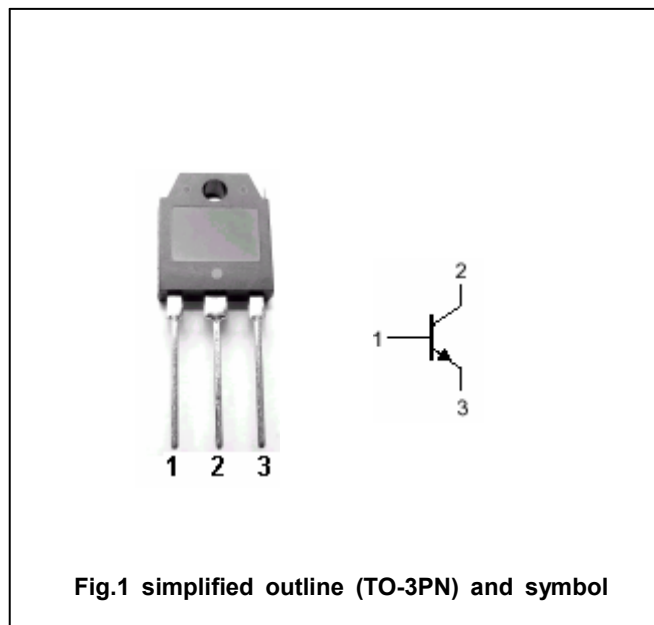

Fig.1 simplified outline (TO-3PN) and symbol

Absolute maximum ratings(Ta=□)

SYMBOL	PARAMETER	CONDITIONS	VALUE	UNIT
V_{CBO}	Collector-base voltage	Open emitter	500	V
V_{CEO}	Collector-emitter voltage	Open base	400	V
V_{EBO}	Emitter-base voltage	Open collector	10	V
I_C	Collector current		12	A
I_{CM}	Collector current-peak		24	A
I_B	Base current		4	A
P_C	Collector power dissipation	$T_C=25^\circ$	100	W
T_j	Junction temperature		150	□
T_{stg}	Storage temperature		-55~150	□

Silicon NPN Power Transistors

2SC5071

CHARACTERISTICS

T_j=25 °C unless otherwise specified

SYMBOL	PARAMETER	CONDITIONS	MIN	TYP.	MAX	UNIT
V _{(BR)CEO}	Collector-emitter breakdown voltage	I _C =25mA ; I _B =0	400			V
V _{CEsat}	Collector-emitter saturation voltage	I _C =7A ; I _B =1.4A			0.5	V
V _{CEsat}	Collector-emitter saturation voltage	I _C =7A ; I _B =1.4A			1.3	V
I _{CBO}	Collector cut-off current	V _{CB} =500V ; I _E =0			100	μA
I _{EBO}	Emitter cut-off current	V _{EB} =10V ; I _C =0			100	μA
h _{FE}	DC current gain	I _C =7A ; V _{CE} =4V	10		30	
C _{OB}	Output capacitance	I _E =0 ; V _{CB} =10V, f=1MHz		105		pF
f _T	Transition frequency	I _E =-1A ; V _{CE} =12V		10		MHz

Switching times

t _{on}	Turn-on time	I _C =7A; R _L =28.5Ω I _{B1} =0.7A; I _{B2} =-1.4A V _{CC} =200V			1.0	μs
t _s	Storage time				3.0	μs
t _f	Fall time				0.5	μs

Silicon NPN Power Transistors

2SC5071

PACKAGE OUTLINE

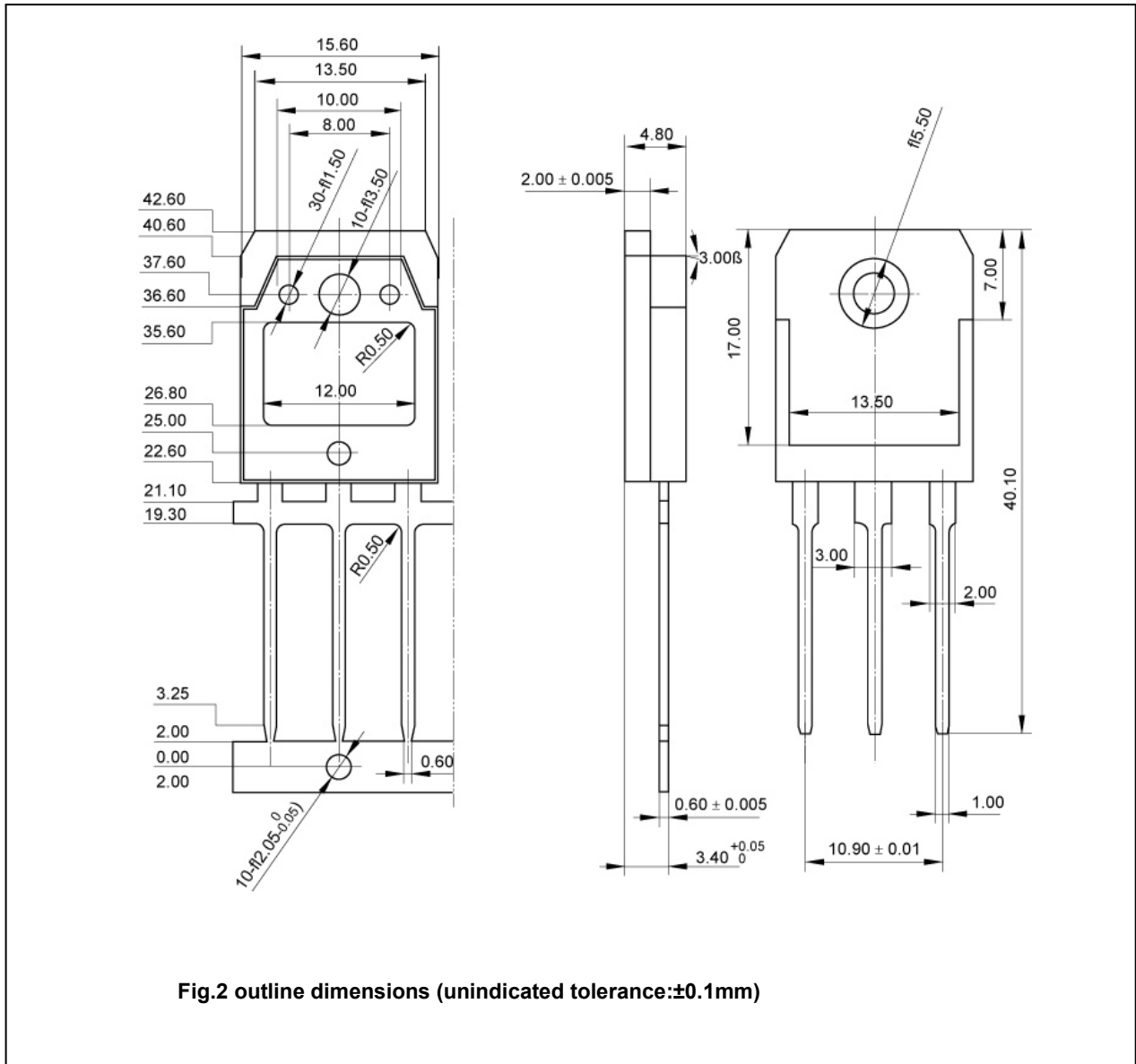

Fig.2 outline dimensions (unindicated tolerance:±0.1mm)

Silicon NPN Power Transistors

2SC5071

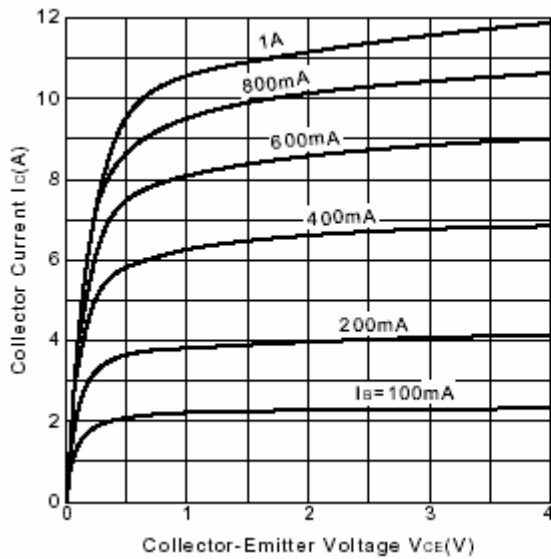

Fig.3 Static Characteristic

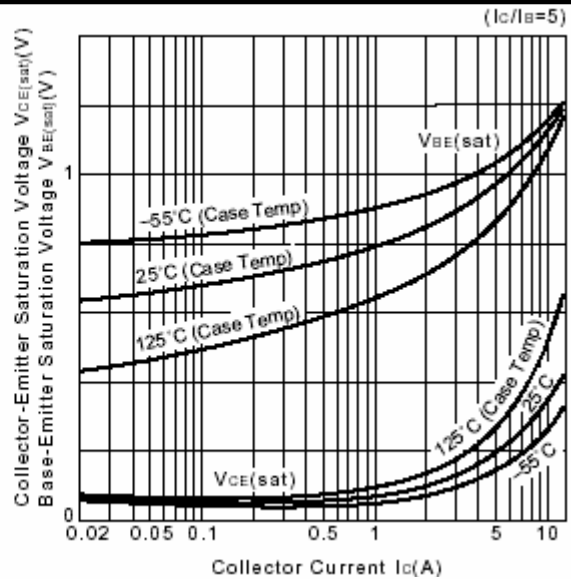

Fig.4 Base-Emitter Saturation Voltage
Collector-Emitter Saturation Voltage

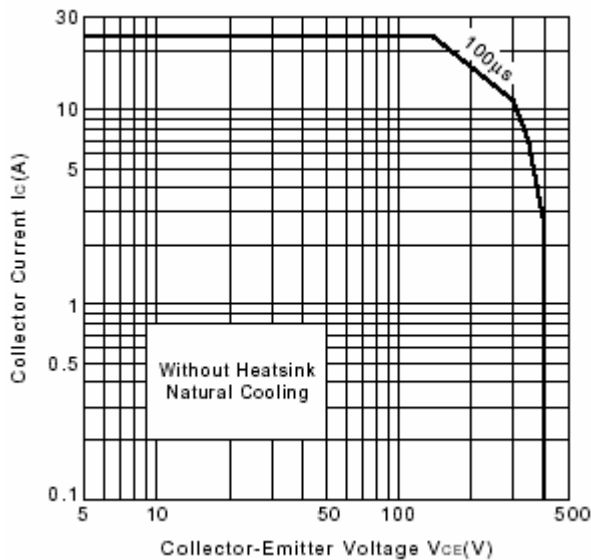

Fig.5 Safe Operating Area

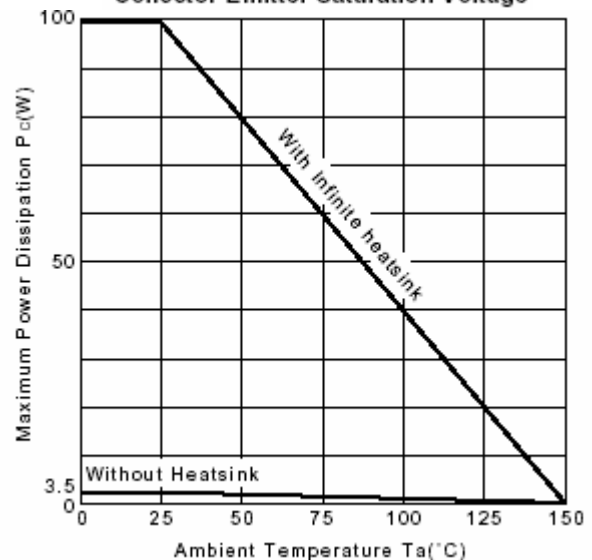

Fig.6 Power Derating

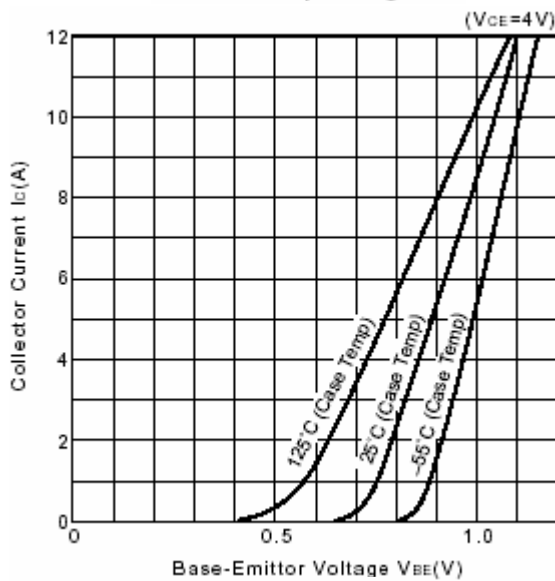

Fig.7 $I_c - V_{BE}$

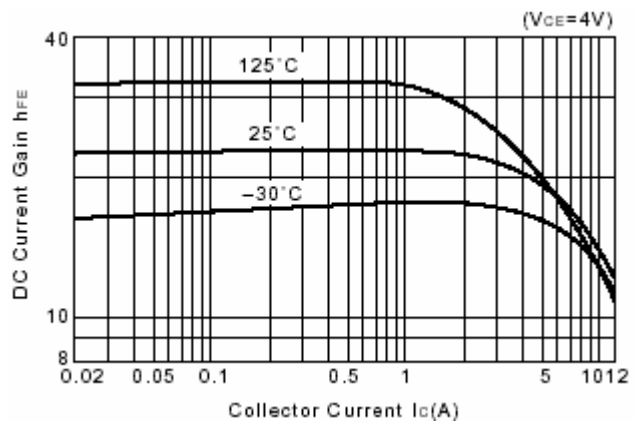

Fig.8 DC current Gain