

Silicon NPN Power Transistors

2SC5124

DESCRIPTION

- With TO-3PML package
- High voltage switching transistor

APPLICATIONS

- Display horizontal deflection output
- Switching regulator and general purpose

PINNING

PIN	DESCRIPTION
1	Base
2	Collector
3	Emitter

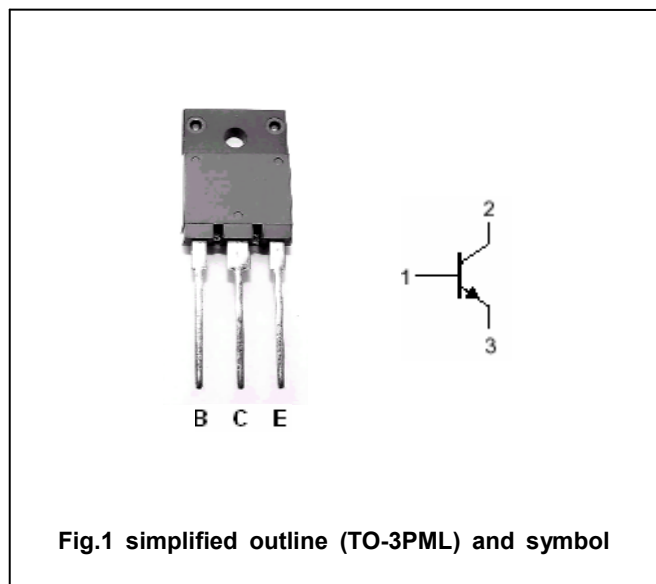

Fig.1 simplified outline (TO-3PML) and symbol

Absolute maximum ratings($T_a=25^\circ\text{C}$)

SYMBOL	PARAMETER	CONDITIONS	VALUE	UNIT
V_{CBO}	Collector-base voltage	Open emitter	1500	V
V_{CEO}	Collector-emitter voltage	Open base	800	V
V_{EBO}	Emitter-base voltage	Open collector	6	V
I_C	Collector current		10	A
I_{CM}	Collector current-peak		20	A
I_B	Base current		5	A
P_C	Collector power dissipation	$T_C=25^\circ\text{C}$	100	W
T_j	Junction temperature		150	$^\circ\text{C}$
T_{stg}	Storage temperature		-55~150	$^\circ\text{C}$

Silicon NPN Power Transistors

2SC5124

CHARACTERISTICS

T_j=25°C unless otherwise specified

SYMBOL	PARAMETER	CONDITIONS	MIN	TYP.	MAX	UNIT
V _{(BR)CEO}	Collector-emitter breakdown voltage	I _C =10mA; R _{BE} =∞	800			V
V _{CEsat}	Collector-emitter saturation voltage	I _C =8A; I _B =2A			5	V
V _{BEsat}	Base-emitter saturation voltage	I _C =8A; I _B =2A			1.5	V
I _{CBO1}	Collector cut-off current	V _{CB} =1200V; I _E =0			100	μA
I _{CBO2}	Collector cut-off current	V _{CB} =1500V; I _E =0			1	mA
I _{EBO}	Emitter cut-off current	V _{EB} =6V; I _C =0			100	μA
h _{FE-1}	DC current gain	I _C =1A; V _{CE} =5V	8			
h _{FE-2}	DC current gain	I _C =8A; V _{CE} =5V	4		9	
f _T	Transition frequency	I _E =-1A; V _{CE} =12V		3		MHz
C _{OB}	Output capacitance	V _{CB} =10V; f=1MHz		130		pF

Switching times

t _{on}	Turn-on time	I _C =6A; I _{B1} =1.2A; I _{B2} =-2.4A R _L =33.3Ω; V _{CC} =200V		0.1		μs
t _{stg}	Storage time			4.0		μs
t _f	Fall time			0.2		μs

Silicon NPN Power Transistors

2SC5124

PACKAGE OUTLINE

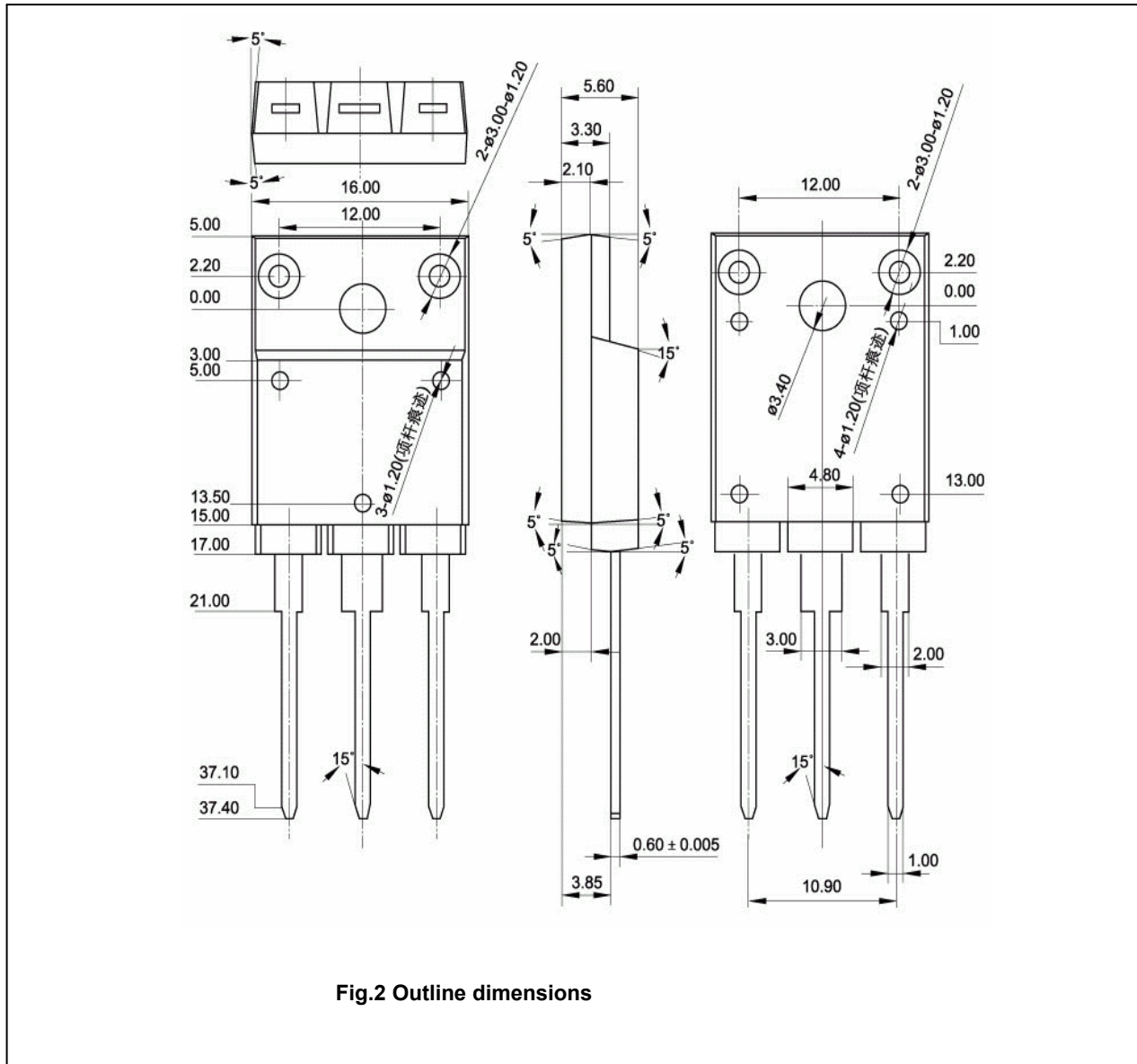

Fig.2 Outline dimensions

Silicon NPN Power Transistors

2SC5124

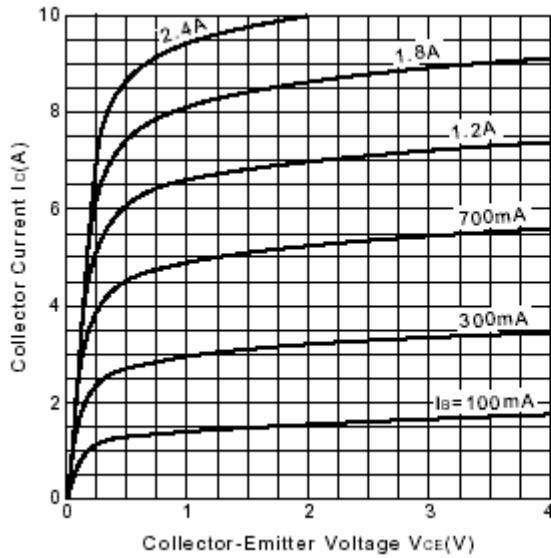

Fig.3 Static Characteristic

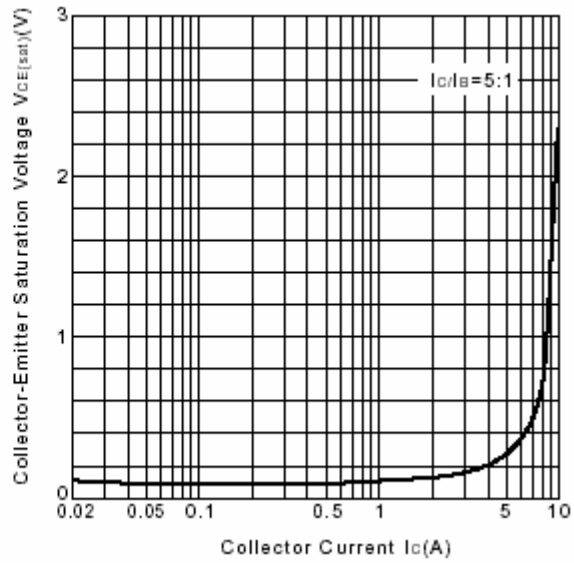

Fig.4 $V_{CE(sat)}$ - I_C Characteristics

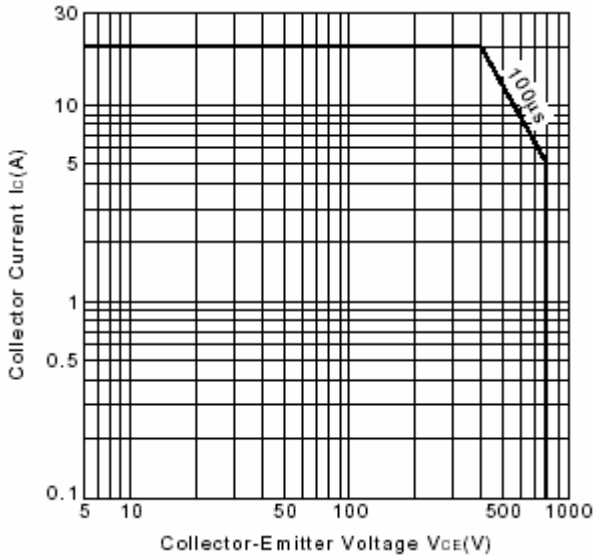

Fig.5 Safe Operating Area

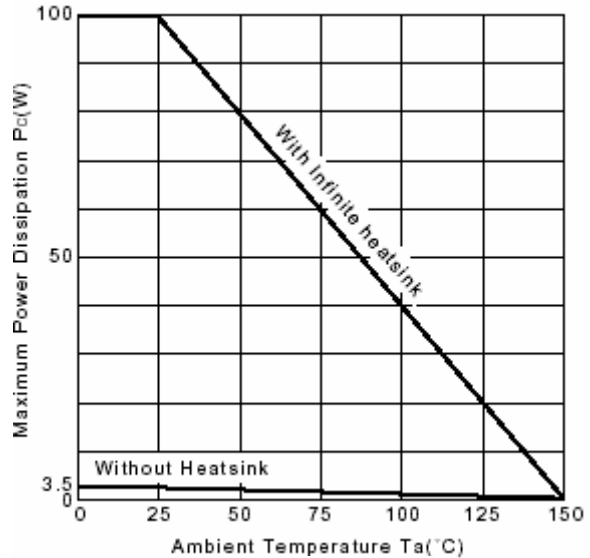

Fig.6 P_C - T_a Derating

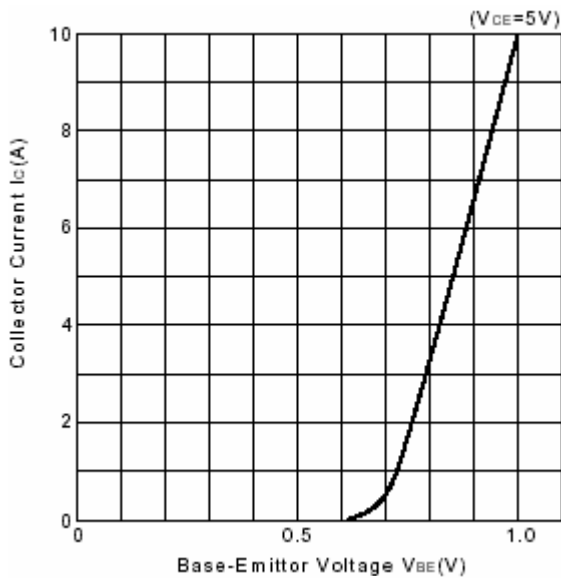

Fig.7 I_C - V_{BE}

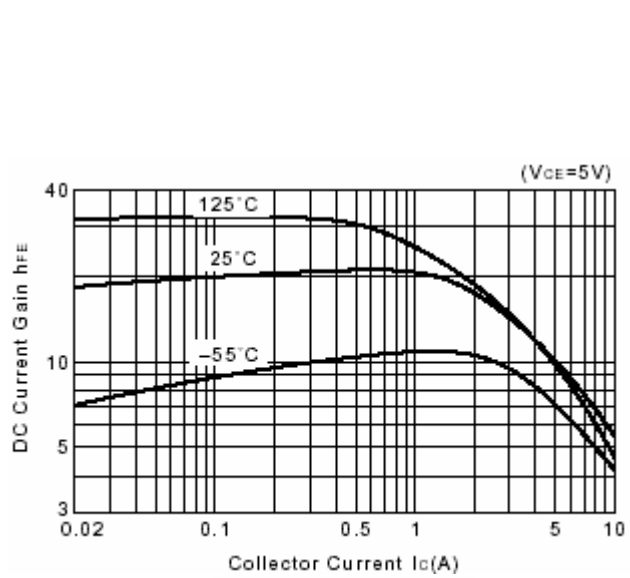

Fig.8 DC current Gain