

Silicon NPN Power Transistors

2SD1235

DESCRIPTION

www.dataSheet4U.com

- With TO-220C package
- Complement to type 2SB919
- Low collector saturation voltage
- Large current capacity.

APPLICATIONS

- Large current switching of relay drivers, high-speed inverters,converters

PINNING

PIN	DESCRIPTION
1	Base
2	Collector;connected to mounting base
3	Emitter

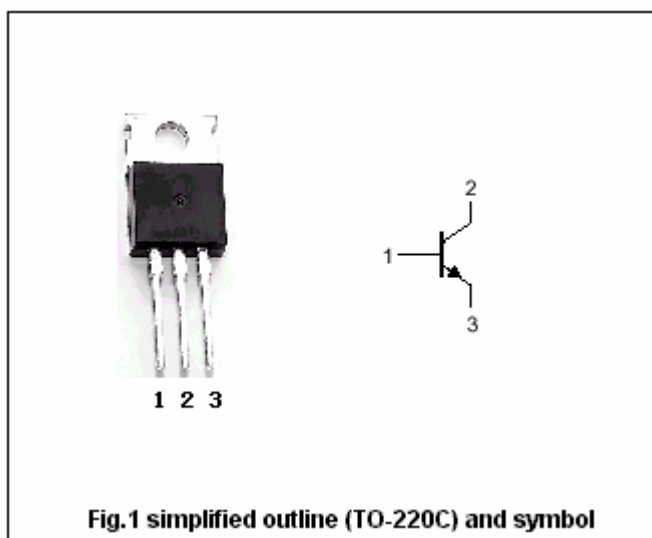

Absolute maximum ratings(Ta=25°C)

SYMBOL	PARAMETER	CONDITIONS	VALUE	UNIT
V _{CBO}	Collector-base voltage	Open emitter	60	V
V _{CEO}	Collector-emitter voltage	Open base	30	V
V _{EBO}	Emitter-base voltage	Open collector	6	V
I _C	Collector current (DC)		8	A
I _{CM}	Collector current-peak		15	A
P _C	Collector dissipation	T _C =25°C	30	W
			1.75	
T _j	Junction temperature		150	°C
T _{stg}	Storage temperature		-55~150	°C

Silicon NPN Power Transistors

2SD1235

CHARACTERISTICS

T_j=25°C unless otherwise specified

www.datasheet4u.com

SYMBOL	PARAMETER	CONDITIONS	MIN	TYP.	MAX	UNIT
V _{(BR)CEO}	Collector-emitter breakdown voltage	I _C =1mA ; R _{BE} =∞	30			V
V _{(BR)CBO}	Collector-base breakdown voltage	I _C =1mA ; I _E =0	60			V
V _{(BR)EBO}	Emitter-base breakdown voltage	I _E =1mA ; I _C =0	6			V
V _{CEsat}	Collector-emitter saturation voltage	I _C =3A ; I _B =0.15A			0.4	V
I _{CBO}	Collector cut-off current	V _{CB} =40V ; I _E =0			100	μA
I _{EBO}	Emitter cut-off current	V _{EB} =4V ; I _C =0			100	μA
h _{FE-1}	DC current gain	I _C =1A ; V _{CE} =2V	70		280	
h _{FE-2}	DC current gain	I _C =4A ; V _{CE} =2V	30			
f _T	Transition frequency	I _C =1A ; V _{CE} =5V		120		MHz

Switching times

t _{on}	Turn-on time	I _C =20I _{B1} =-20I _{B2} =4A V _{CC} =10V, R _L =2.5Ω		0.1		μs
t _s	Storage time			0.5		μs
t _f	Fall time			0.03		μs

◆ h_{FE-1} Classifications

Q	R	S
70-140	100-200	140-280

Silicon NPN Power Transistors

2SD1235

PACKAGE OUTLINE

www.datasheet4u.com

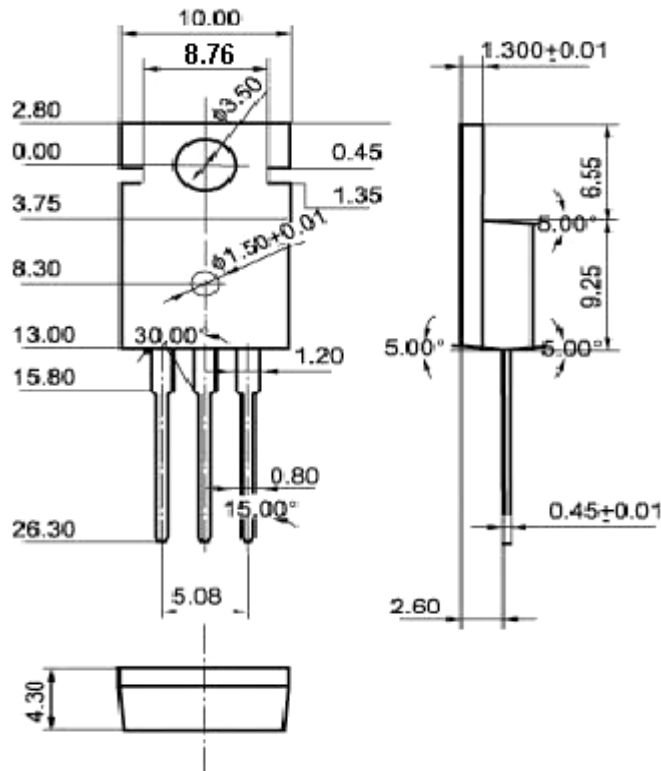

Fig.2 Outline dimensions (unindicated tolerance: ± 0.10 mm)

Silicon NPN Power Transistors

2SD1235

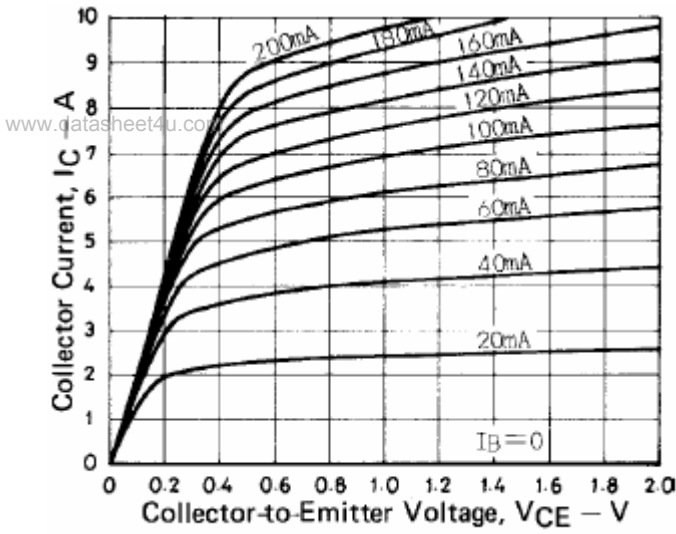

Fig.3 Static Characteristic

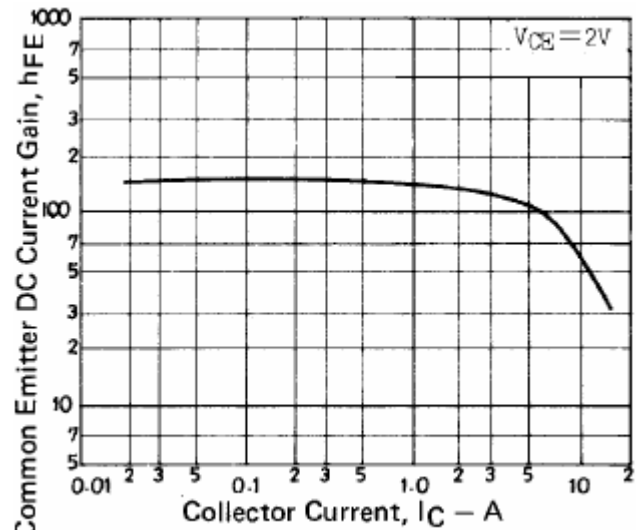

Fig.4 DC current Gain

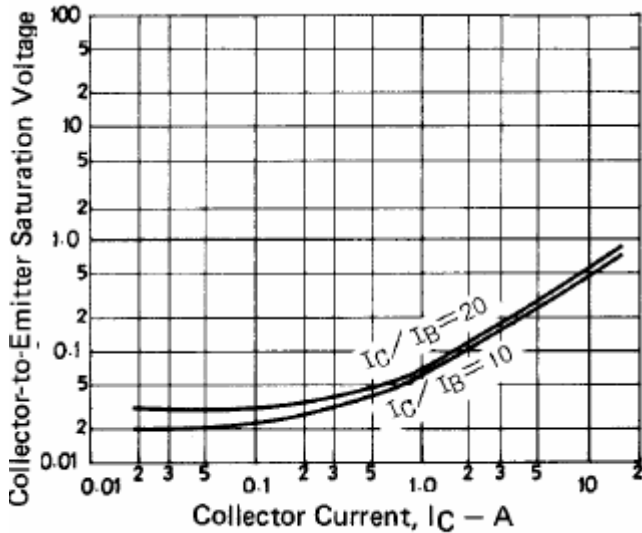

Fig.5 Collector-Emitter Saturation Voltage

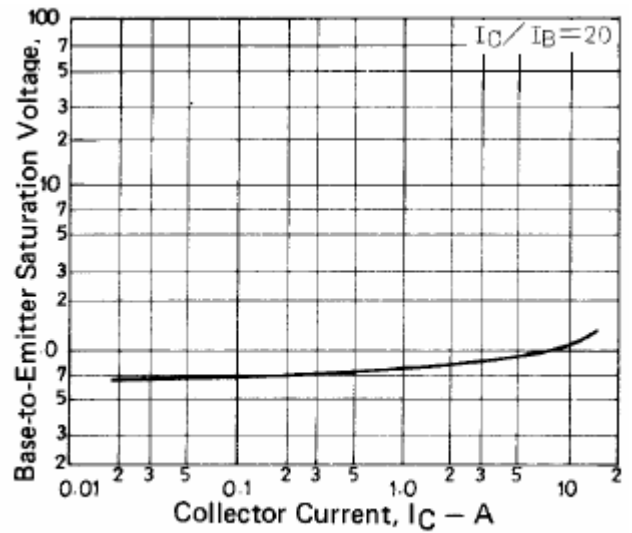

Fig.6 Base-Emitter Saturation Voltage

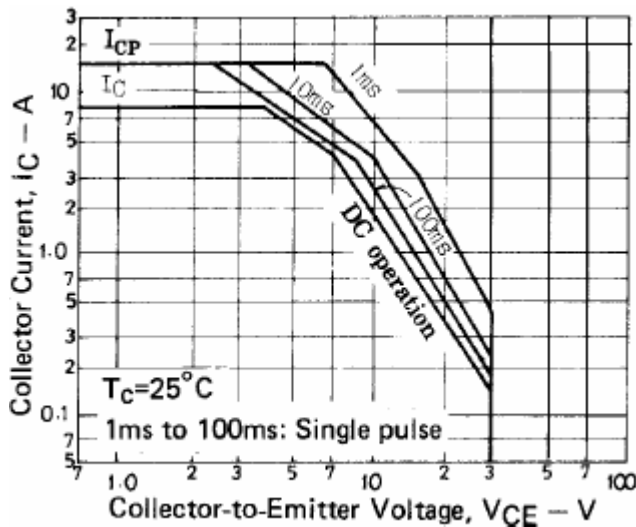

Fig.7 Safe Operating Area